

# GP-X SERIES

- FIBER SENSORS
- LASER SENSORS
- PHOTOELECTRIC SENSORS
- MICRO PHOTOELECTRIC SENSORS
- AREA SENSORS
- SAFETY LIGHT CURTAINS / SAFETY COMPONENTS
- PRESSURE / FLOW SENSORS
- INDUCTIVE PROXIMITY SENSORS
- PARTICULAR USE SENSORS
- SENSOR OPTIONS
- SIMPLE WIRE- SAVING UNITS
- WIRE- SAVING SYSTEMS
- MEASUREMENT SENSORS
- STATIC CONTROL DEVICES
- LASER MARKERS
- PLC
- HUMAN MACHINE INTERFACES
- ENERGY MANAGEMENT SOLUTIONS
- FA COMPONENTS
- MACHINE VISION SYSTEMS
- UV CURING SYSTEMS
- Selection Guide
- Laser Displacement
- Magnetic Displacement
- Contact Displacement
- Collimated Beam Sensors
- Metal-sheet Double-feed Detection
- Digital Panel Controller
- Other Products
- GP-X
- GP-A

Related Information

- General terms and conditions..... F-3
- Selection guide ..... P.1021~
- Glossary of terms..... P.1587
- General precautions ..... P.1595



[panasonic.net/id/pidsx/global](http://panasonic.net/id/pidsx/global)

## High-speed sampling and high resolution. The new choice for even more variegated data collection and processing.

### They perform with a $\pm 0.3\%$ F.S. linearity for stainless steel and iron

Because they perform with a  $\pm 0.3\%$  F.S. linearity, they can be used for sensing stainless steel and iron enabling precise measurements not affected by the work's material. Specifications corresponding to each material (stainless steel, iron, aluminum) has already been inputted in the controller enabling the easy selection of the setting that is the most suitable for the particular material used.

#### Optimal correction of the output feature

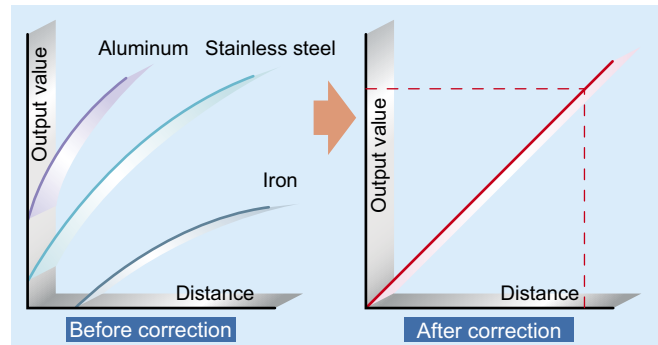

### We've realized a 25 $\mu$ s (40,000 times/sec.) ultra high sampling speed

With a 25  $\mu$ s ultra high sampling speed, the GP-X series won't miss even high speed work displacements.

### They possess a 0.02 % F.S. resolution for highly accurate measurement

With high resolution, 0.02 % F.S. (Note), they can perform high-accuracy measurements of micro-displacements. In particular, the sensor head GP-X3SE for 0.8 mm 0.049 in sensing can differentiate ultra micro displacement of 0.32  $\mu$ m 0.013 mil (Average number of samples: 64).  
 Note: GP-XC3SE and GP-XC5SE  
 Resolution: 0.04 % F.S.

### These devices boast a 0.07 % F.S./ $^{\circ}$ C temperature characteristics

By combining the sensor head with the controller, we've realized 0.07 % F.S./ $^{\circ}$ C. They are highly resistant to ambient temperature changes enabling stable micro-displacement measurements.

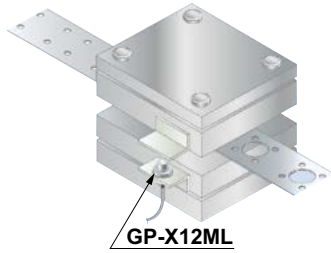
**APPLICATIONS**
**Stroke end sensing**

**Eccentricity sensing**

**Height sensing**

**ENVIRONMENTAL RESISTANCE / VARIETY**
**IP67G sensor head variation**

6 types of sensor heads from the ultra compact  $\varnothing 3.8$  mm  $\varnothing 0.150$  in cylindrical type to the long range sensing type  $\varnothing 22$  mm  $\varnothing 0.866$  in are available. All sensor heads are oil-proof as per IP67G enabling safe, stable performance.

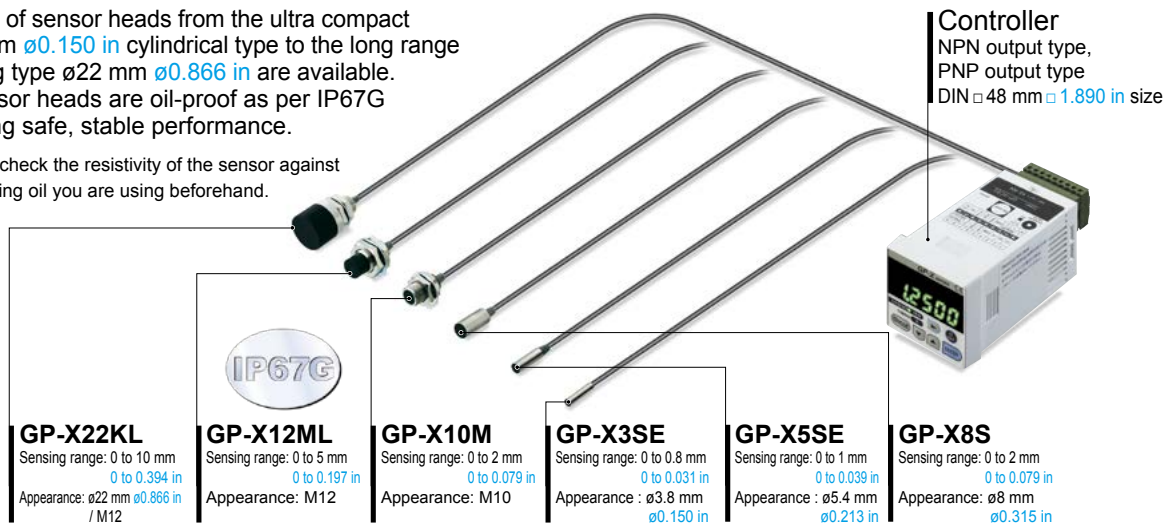
\* Please check the resistivity of the sensor against the cutting oil you are using beforehand.



**GP-X22KL**  
Sensing range: 0 to 10 mm  
0 to 0.394 in  
Appearance:  $\varnothing 22$  mm  $\varnothing 0.866$  in / M12

**GP-X12ML**  
Sensing range: 0 to 5 mm  
0 to 0.197 in  
Appearance: M12

**GP-X10M**  
Sensing range: 0 to 2 mm  
0 to 0.079 in  
Appearance: M10

**GP-X3SE**  
Sensing range: 0 to 0.8 mm  
0 to 0.031 in  
Appearance:  $\varnothing 3.8$  mm  $\varnothing 0.150$  in

**GP-X5SE**  
Sensing range: 0 to 1 mm  
0 to 0.039 in  
Appearance:  $\varnothing 5.4$  mm  $\varnothing 0.213$  in

**GP-X8S**  
Sensing range: 0 to 2 mm  
0 to 0.079 in  
Appearance:  $\varnothing 8$  mm  $\varnothing 0.315$  in

**MOUNTING / MAINTENANCE**
**Sensor heads with superior workability and maintainability**
**Replacement of sensor heads possible**

As a result of damage or other mishap rendering maintenance necessary, you can replace the sensor head with new one leaving the controller as it is.

**One-touch connector hook up**

The sensor head and the controller connection is a simple one-touch connector type.

**Sensor head extensions possible**

Between the sensor head and the controller, a **GP-XCCJ7** extension cable (optional) can be used up to a 10 m **32.808 ft** total length.

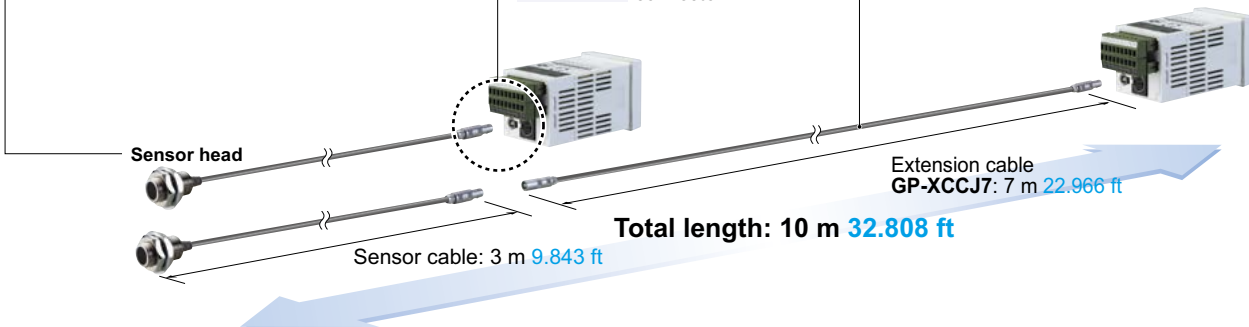

FIBER SENSORS

LASER SENSORS

PHOTOELECTRIC SENSORS

MICRO PHOTOELECTRIC SENSORS

AREA SENSORS

SAFETY LIGHT CURTAINS / SAFETY COMPONENTS

PRESSURE / FLOW SENSORS

INDUCTIVE PROXIMITY SENSORS

PARTICULAR USE SENSORS

SENSOR OPTIONS

SIMPLE WIRE-SAVING UNITS

WIRE-SAVING SYSTEMS

MEASUREMENT SENSORS

STATIC CONTROL DEVICES

LASER MARKERS

PLC

HUMAN MACHINE INTERFACES

ENERGY MANAGEMENT SOLUTIONS

FA COMPONENTS

MACHINE VISION SYSTEMS

UV CURING SYSTEMS

Selection Guide
Laser Displacement
Magnetic Displacement
Contact Displacement
Collimated Beam Sensors
Metal-sheet Double-feed Detection
Digital Panel Controller
Other Products

**GP-X**
**GP-A**

- FIBER SENSORS
- LASER SENSORS
- PHOTOELECTRIC SENSORS
- MICRO PHOTOELECTRIC SENSORS
- AREA SENSORS
- SAFETY LIGHT CURTAINS / SAFETY COMPONENTS
- PRESSURE / FLOW SENSORS
- INDUCTIVE PROXIMITY SENSORS
- PARTICULAR USE SENSORS
- SENSOR OPTIONS
- SIMPLE WIRE-SAVING UNITS
- WIRE-SAVING SYSTEMS
- MEASUREMENT SENSORS
- STATIC CONTROL DEVICES
- LASER MARKERS
- PLC
- HUMAN MACHINE INTERFACES
- ENERGY MANAGEMENT SOLUTIONS
- FA COMPONENTS
- MACHINE VISION SYSTEMS
- UV CURING SYSTEMS
- Selection Guide
- Laser Displacement
- Magnetic Displacement
- Contact Displacement
- Collimated Beam Sensors
- Metal-sheet Double-feed Detection
- Digital Panel Controller
- Other Products
- GP-X**
- GP-A**

## FUNCTIONS

### The 5-digit, dual, 2-color digital display offers great visibility

If the measurement results fall within the setting range (GO), they will appear on the lower digital display in green. If they are out of range (HI, LO), they will be displayed in the upper digital display in orange. The display position and color change allows for accurate visibility even for momentary changes.

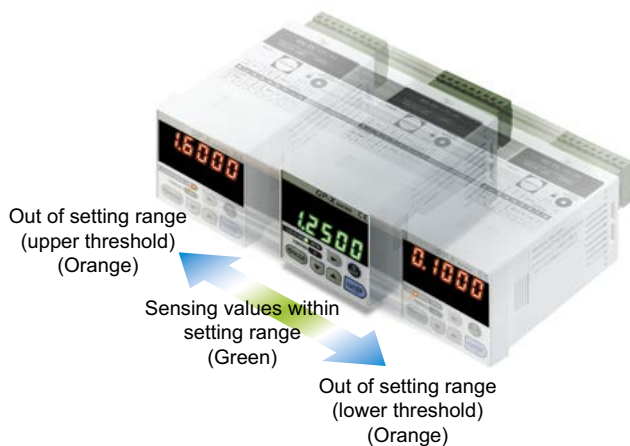

### Digital input display enabling easy setting

Its dual digital display enables numerical setting while verifying setting items for each mode. Even when sensing, it enables the verification of the main settings.

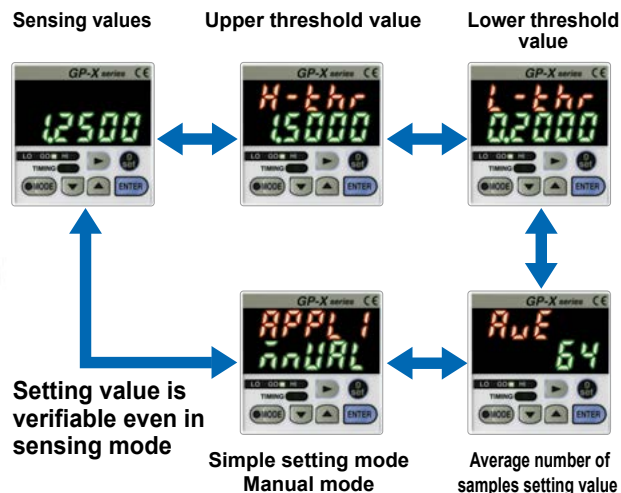

### The RS-232C communication connector is standard equipment

It is capable of various controls such as saving measurement data to PC and the controller's inputted settings and loading stored memory.

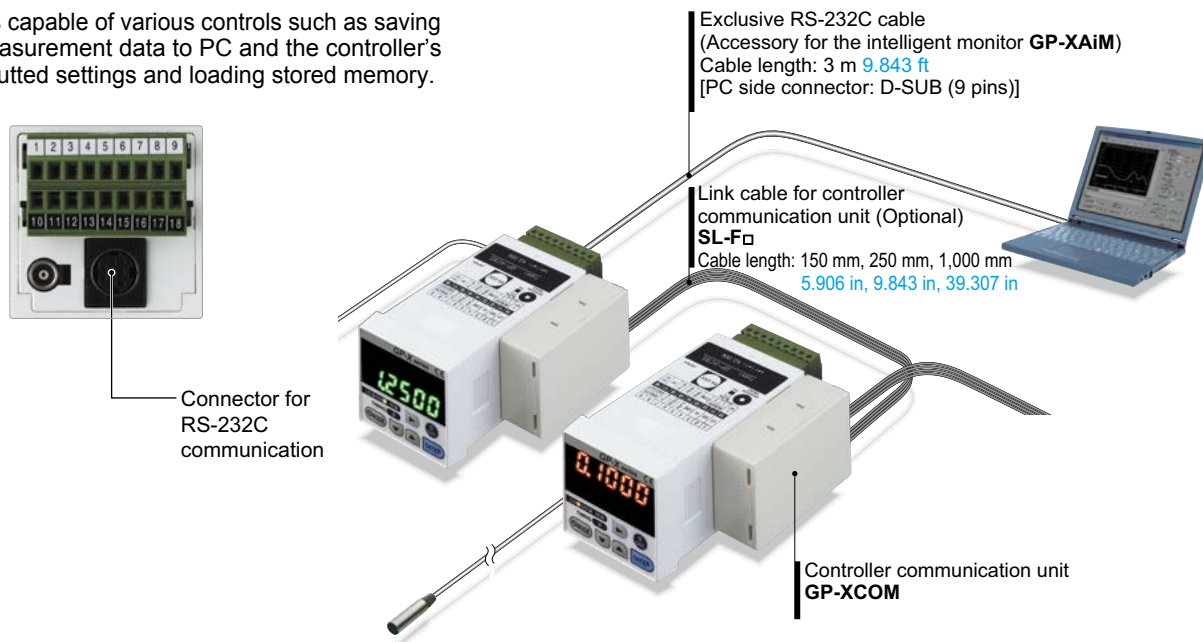

### Enables sensors data comparisons and calculations

3-value judgment output for calculating measurement data conformity and calculation results between 2 interconnected controllers is rendered possible. The calculation function equipment renders digital panel controllers unnecessary.

**OPTIONS**

**Datalink between sensors possible**

The controller communication unit **GP-XCOM** (optional) can be linked to up to 8 controllers and load via just one RS-232C cable each controller settings and measurement data to a PC.

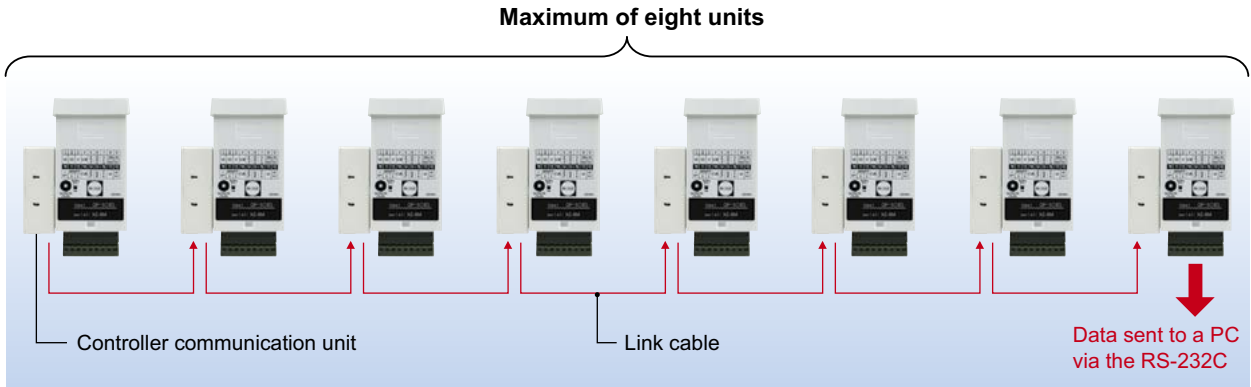

**An intelligent monitor (GP-XAIM) optimal for collecting and analyzing measurement data is also available**

An intelligent monitor capable of the settings for each measurement conditions and waveform display monitoring. It can perform waveform monitoring, which could until now only be done by the oscilloscope, as well as the simple loading and saving onto a PC of settings for each condition and function. (Exclusive RC-232C cable is attached.)



**BCD output unit GP-XBCD (Optional)**

**20 kHz high-speed data output**

The measurement data can be processed quickly in the PLC. (Sampling rate: 20 kHz)

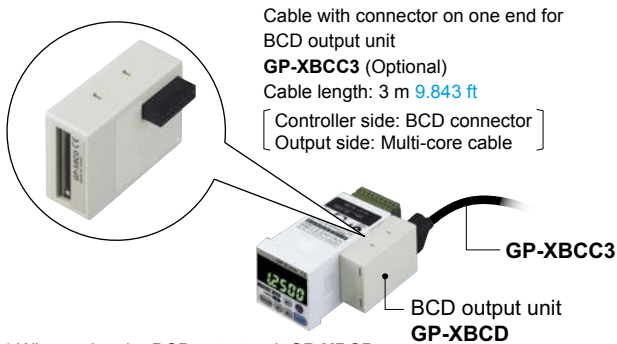

\* When using the BCD output unit **GP-XBCD**, the analog voltage output of a controller becomes invalid.

**4 types of measurement modes available**

Measurement modes compatible to the most widely used applications are available. Because of this, inputting setting values can be done with ease. Please select the most appropriate mode to suit your specific application.

**Mutual interference prevention function**

The sensor head can be made interference prevention by linking up to 8 controllers via an interference prevention output cable and shifting the oscillation timing. This enables precise measurements to be obtained even in cases where many sensor heads are crowded in the same area.

**Removable type terminal block**

It is equipped with a removable type European terminal block very convenient during assembly, when dividing the equipment into segments or when performing maintenance. It also features an reverse insertion prevention construction.



European terminal block

**4 types of selectable memory functions**

The setting data can be processed in 4 types of memory when measuring. This function enables either the changing of the workpiece, the sensing of multiple products or sensing after product changeover to be done smoothly.

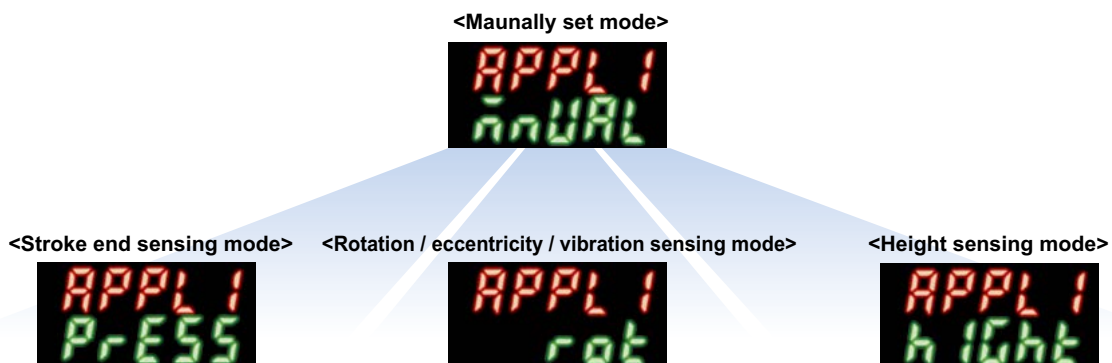

- FIBER SENSORS
- LASER SENSORS
- PHOTOELECTRIC SENSORS
- MICRO PHOTOELECTRIC SENSORS
- AREA SENSORS
- SAFETY LIGHT CURTAINS / SAFETY COMPONENTS
- PRESSURE / FLOW SENSORS
- INDUCTIVE PROXIMITY SENSORS
- PARTICULAR USE SENSORS
- SENSOR OPTIONS
- SIMPLE WIRE-SAVING UNITS
- WIRE-SAVING SYSTEMS

**MEASUREMENT SENSORS**

- STATIC CONTROL DEVICES
- LASER MARKERS

**PLC**

- HUMAN MACHINE INTERFACES

- ENERGY MANAGEMENT SOLUTIONS

- FA COMPONENTS

- MACHINE VISION SYSTEMS

- UV CURING SYSTEMS

- Selection Guide
- Laser Displacement
- Magnetic Displacement
- Contact Displacement
- Collimated Beam Sensors
- Metal-sheet Double-feed Detection
- Digital Panel Controller
- Other Products

**GP-X**

**GP-A**

- FIBER SENSORS
- LASER SENSORS
- PHOTO-ELECTRIC SENSORS
- MICRO PHOTO-ELECTRIC SENSORS
- AREA SENSORS
- SAFETY LIGHT CURTAINS / SAFETY COMPONENTS
- PRESSURE / FLOW SENSORS
- INDUCTIVE PROXIMITY SENSORS
- PARTICULAR USE SENSORS
- SENSOR OPTIONS
- SIMPLE WIRE-SAVING UNITS
- WIRE-SAVING SYSTEMS
- MEASURE-HEIGHT SENSORS
- STATIC CONTROL DEVICES
- LASER MARKERS
- PLC
- HUMAN MACHINE INTERFACES
- ENERGY MANAGEMENT SOLUTIONS
- FA COMPONENTS
- MACHINE VISION SYSTEMS
- UV CURING SYSTEMS

## ORDER GUIDE

Type	Appearance (mm in)		Sensing range	Set model No. (Sensor head model No.)	Comparative output
	Sensor heads	Controller			
Non-threaded type sensor head			0 to 0.8 mm 0 to 0.031 in	<b>GP-XC3SE</b> <b>(GP-X3SE)</b>	NPN open-collector transistor
			0 to 1 mm 0 to 0.039 in	<b>GP-XC5SE</b> <b>(GP-X5SE)</b>	NPN open-collector transistor
			0 to 2 mm 0 to 0.079 in	<b>GP-XC8S</b> <b>(GP-X8S)</b>	NPN open-collector transistor
			0 to 2 mm 0 to 0.079 in	<b>GP-XC8S-P</b> <b>(GP-X8S)</b>	PNP open-collector transistor
			0 to 5 mm 0 to 0.197 in	<b>GP-XC10M</b> <b>(GP-X10M)</b>	NPN open-collector transistor
			0 to 5 mm 0 to 0.197 in	<b>GP-XC10M-P</b> <b>(GP-X10M)</b>	PNP open-collector transistor
Threaded type sensor head			0 to 10 mm 0 to 0.394 in	<b>GP-XC12ML</b> <b>(GP-X12ML)</b>	NPN open-collector transistor
			0 to 10 mm 0 to 0.394 in	<b>GP-XC12ML-P</b> <b>(GP-X12ML)</b>	PNP open-collector transistor
			0 to 10 mm 0 to 0.394 in	<b>GP-XC22KL</b> <b>(GP-X22KL)</b>	NPN open-collector transistor
			0 to 10 mm 0 to 0.394 in	<b>GP-XC22KL-P</b> <b>(GP-X22KL)</b>	PNP open-collector transistor

- The controller is not available for sale by itself.
- Sensor heads can only be replaced with the sensor heads with the same set model name. Different sensor heads cannot be used.

- Selection Guide
- Laser Displacement
- Magnetic Displacement
- Contact Displacement
- Collimated Beam Sensors
- Metal-sheet Double-feed Detection
- Digital Panel Controller
- Other Products

GP-X

GP-A

## OPTIONS

Designation	Model No.	Description	
BCD output unit	<b>GP-XBCD</b>	This unit outputs measurement values in BCD data format at a high speed. • Sampling frequency: 20 kHz	
Cable with connector on one end for BCD output unit	<b>GP-XBCC3</b>	Length: 3 m <b>9.843 ft</b>	Cable for BCD data output unit • 26-core cable with connector on one end
Controller communication unit	<b>GP-XCOM</b>	Up to 8 controllers can be linked	
Link cable for controller communication unit	<b>SL-F150</b>	Length: 150 mm <b>5.906 in</b>	This cable links the controller communication units. Select as per the cable length.
	<b>SL-F250</b>	Length: 250 mm <b>9.843 in</b>	
	<b>SL-F1000</b>	Length: 1,000 mm <b>39.370 in</b>	
Intelligent monitor	<b>GP-XAiM</b>	Monitoring settings for each measurement condition and measurement waveforms is enabled by way of a PC. • One exclusive RS-232C cable (3 m <b>9.843 ft</b> length) is attached.	
Extension cable for sensor head	<b>GP-XCCJ7</b>	Length: 7 m <b>22.966 ft</b>	This cable with connector is for extensions between the sensor head and controller.
Sensor head mounting bracket	<b>MS-SS3</b>	Mounting bracket for <b>GP-X3SE</b>	
	<b>MS-SS5</b>	Mounting bracket for <b>GP-X5SE</b>	
	<b>MS-SS8</b>	Mounting bracket for <b>GP-X8S</b>	

### BCD output unit

#### Cable with connector on one end for BCD output unit

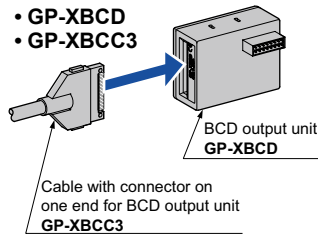

### Controller communication unit

#### Link cable for controller communication unit

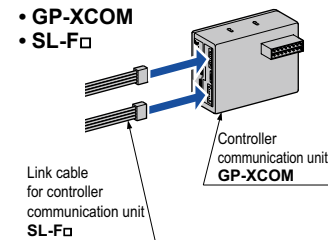

### Intelligent monitor

- **GP-XAiM**



### Extension cable for sensor head

- **GP-XCCJ7**

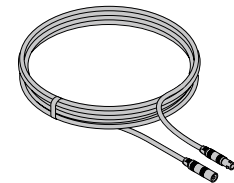

### Sensor head mounting bracket

- **MS-SS□**

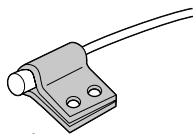

The sensor head can be easily fixed.

FIBER SENSORS

LASER SENSORS

PHOTO-ELECTRIC SENSORS

MICRO PHOTO-ELECTRIC SENSORS

AREA SENSORS

SAFETY LIGHT CURTAINS / SAFETY COMPONENTS

PRESSURE / FLOW SENSORS

INDUCTIVE PROXIMITY SENSORS

PARTICULAR USE SENSORS

SENSOR OPTIONS

SIMPLE WIRE-SAVING UNITS

WIRE-SAVING SYSTEMS

MEASUREMENT SENSORS

STATIC CONTROL DEVICES

LASER MARKERS

PLC

HUMAN MACHINE INTERFACES

ENERGY MANAGEMENT SOLUTIONS

FA COMPONENTS

MACHINE VISION SYSTEMS

UV CURING SYSTEMS

Selection Guide

Laser Displacement

Magnetic Displacement

Contact Displacement

Collimated Beam Sensors

Metal-sheet Double-feed Detection

Digital Panel Controller

Other Products

**GP-X**
**GP-A**

## SPECIFICATIONS

### Controllers

Type	NPN output	PNP output	
Item	GP-XC□	GP-XC□-P	
CE marking directive compliance	EMC Directive, RoHS Directive		
Supply voltage	24 V DC ±10 % Ripple P-P 10 % or less		
Current consumption	150 mA or less		
Resolution (Note 2)	<b>GP-XC3SE / GP-XC5SE:</b> 0.04 % F.S. (64 times average processing) <b>GP-XC8S / GP-XC10M / GP-XC12ML / GP-XC22KL:</b> 0.02 % F.S. (64 times average processing)		
Sampling frequency	40 kHz (25 μs)		
Linearity (Note 2)	Within ±0.3 % F.S.		
Temperature characteristics (Note 3)	0.07 % F.S./°C or less		
Analog voltage outputs (Note 4)	Output voltage: -5 to +5 V (Note 5), Output impedance: 100 Ω approx.		
Response time	75 μs (maximum speed)		
Comparative outputs (HI, GO, LO)	NPN open-collector transistor <ul style="list-style-type: none"> <li>• Maximum sink current: 100 mA</li> <li>• Applied voltage: 30 V DC or less (between comparative output and 0 V)</li> <li>• Residual voltage: 1.6 V or less (at 100 mA sink current) 0.4 V or less (at 16 mA sink current)</li> </ul>	PNP open-collector transistor <ul style="list-style-type: none"> <li>• Maximum source current: 100 mA</li> <li>• Applied voltage: 30 V DC or less (between comparative output and +V)</li> <li>• Residual voltage: 1.6 V or less (at 100 mA source current) 0.4 V or less (at 16 mA source current)</li> </ul>	
Utilization category	DC-12 or DC-13		
Output number	HI / GO / LO 3 value output		
Output operation	HI : ON when measured value > the upper limit value GO: ON when upper limit value ≥ measured value ≥ lower limit value LO : ON when lower limit value > measured value		
Short-circuit protection	Incorporated		
External input	Photo-coupler input <ul style="list-style-type: none"> <li>• Input current: 9 mA or less</li> <li>• Operating voltage: ON voltage 17 V or more (between +24 V and input) OFF voltage 4 V or less (between +24 V and input)</li> <li>• Input impedance: 5 kΩ approx.</li> </ul>	Photo-coupler input <ul style="list-style-type: none"> <li>• Input current: 9 mA or less</li> <li>• Operating voltage: ON voltage 17 V or more (between 0 V and input) OFF voltage 4 V or less (between 0 V and input)</li> <li>• Input impedance: 5 kΩ approx.</li> </ul>	
Serial I/O	RS-232C		
Zero-set setting method	Push button setting / External input setting		
Indicators	MODE	Orange LED (lights up when in mode status)	
	HI	Orange LED (lights up when the upper limit value is exceeded)	
	GO	Green LED (lights up when within the upper and lower limit value)	
	LO	Orange LED (lights up when less than the lower limit value)	
	TIMING	Green LED (lights up as per the external or internal trigger timing)	
Upper level digital display part	5 digit orange LED (display of numerical values out of upper and lower limit value)		
Lower level digital display part	5 digit green LED (display of numerical values within the upper and lower limit value)		
Environmental resistance	Pollution degree	3 (Industrial environment)	
	Ambient temperature	0 to +50 °C <b>+32 to +122 °F</b> (No dew condensation allowed), Storage: 0 to +50 °C <b>+32 to +122 °F</b>	
	Ambient humidity	35 to 85 % RH, Storage: 35 to 85 % RH	
	Vibration resistance	10 to 55 Hz frequency, 0.75 mm <b>0.030 in</b> double amplitude in X, Y and Z directions for two hours each	
	Shock resistance	100 m/s <sup>2</sup> acceleration (10 G approx.) in X, Y and Z directions five times each	
Material	Enclosure: Polycarbonate		
Weight	Net weight: 120 g approx.		
Accessory	<b>ATA4811</b> (Controller mounting frame): 1 set		

Notes: 1) Where measurement conditions have not been specified precisely, the conditions used were an ambient temperature of +20 °C **+68 °F**.

2) This value was obtained at a constant +25 °C **+77 °F**.

3) This value represents 20 to 60 % of the maximum sensing distance when combining the sensor head and controller.

4) When using the BCD output unit **GP-XBCD**, the analog voltage output of a controller becomes invalid.

5) Adjusted to a 0 to +5 V factory setting.

## SPECIFICATIONS

### Sensor heads

Item	Model No.	Non-threaded type			Threaded type		
		For 0.8 mm <b>0.031 in</b> sensing	For 1 mm <b>0.039 in</b> sensing	For 2 mm <b>0.079 in</b> sensing	For 2 mm <b>0.079 in</b> sensing	For 5 mm <b>0.197 in</b> sensing	For 10 mm <b>0.394 in</b> sensing
		<b>GP-X3SE</b>	<b>GP-X5SE</b>	<b>GP-X8S</b>	<b>GP-X10M</b>	<b>GP-X12ML</b>	<b>GP-X22KL</b>
Sensing range (Note 2)		0 to 0.8 mm <b>0 to 0.031 in</b>	0 to 1 mm <b>0 to 0.039 in</b>	0 to 2 mm <b>0 to 0.079 in</b>	0 to 2 mm <b>0 to 0.079 in</b>	0 to 5 mm <b>0 to 0.197 in</b>	0 to 10 mm <b>0 to 0.394 in</b>
Standard sensing object		Stainless steel (SUS304) / Iron sheet [Cold rolled carbon steel (SPCC)] 60 × 60 × t 1 mm <b>2.362 × 2.362 × t 0.039 in</b>					
Temperature characteristics (Note 3)		0.07 % F.S./°C or less					
Environmental resistance	Pollution degree	3 (Industrial environment)					
	Protection	IP67 (IEC), IP67G (Note 6)					
	Ambient temperature	-10 to +55 °C <b>+14 to +131 °F</b> , Storage: -20 to +70 °C <b>-4 to +158 °F</b>					
	Ambient humidity	35 to 85 % RH, Storage: 35 to 85 % RH					
	Voltage withstandability	250 V AC for one min. between all supply terminals connected together and enclosure					
	Insulation resistance	20 MΩ, or more, with 250 V DC megger between all supply terminals connected together and enclosure					
	Vibration resistance	10 to 150 Hz frequency, 0.75 mm <b>0.030 in</b> amplitude in X, Y and Z directions for two hours each					
	Shock resistance	500 m/s <sup>2</sup> acceleration (50 G approx.) in X, Y and Z directions five times each					
Material	Enclosure	Stainless steel (SUS303)			Brass (Nickel plated)		
	Cable protector	PP					
	Sensing part	ABS	PAR	ABS	PA		
Cable	High frequency coaxial cable with connector, 3 m <b>9.843 ft</b> long (Note 4)						
Cable extension	Extension up to total 10 m <b>32.808 ft</b> is possible with the optional cable.						
Net Weight (Note 5)		40 g approx.	40 g approx.	40 g approx.	50 g approx.	45 g approx.	80 g approx.
Accessories					Nut: 2 pcs., Toothed lock washer: 1 pc.		

Notes: 1) Where measurement conditions have not been specified precisely, the conditions used were an ambient temperature of +20 °C **+68 °F**.

2) The sensing range is specified for the standard sensing object.

3) This value represents 20 to 60 % of the maximum sensing distance when combining the sensor head and the controller.

4) For the flexible cable type, please contact our office.

5) The given weight of the threaded type sensor head is the value including the weight of the nuts and the toothed lock washer.

6) If using the sensor in an environment where cutting oil droplets splatter, the sensor may be deteriorated due to added substances in the oil. Please check the resistivity of the sensor against the cutting oil you are using beforehand.

### BCD output unit

Item	Model No.	<b>GP-XBCD</b>
Current consumption		20 mA or less
Outputs (5 digits BCD, Polarity indication, VALID)		N-channel MOSFET open drain <ul style="list-style-type: none"> <li>• Maximum sink current: 50 mA</li> <li>• Applied voltage: 30 V DC or less (between output and GND)</li> <li>• Residual voltage: 1 V or less (at 50 mA sink current)</li> </ul>
Hold input		Non-voltage contact or NPN open-collector transistor input <ul style="list-style-type: none"> <li>• Low: 0 to 1 V</li> <li>• High: Open</li> </ul>
Material		Enclosure: ABS
Weight		Net weight: 30 g approx.
Accessory		Mounting bracket [Stainless steel (SUS304)]: 1 pc.

Note: Connects to the control device with **GP-XBCC3** cable with connector on one end for BCD output unit (3 m **9.843 ft** cable length, optional).

### Controller communication unit

Item	Model No.	<b>GP-XCOM</b>
Current consumption		5 mA or less
Material		Enclosure: ABS
Weight		Net weight: 20 g approx.
Accessory		Mounting bracket [Stainless steel (SUS304)]: 1 pc.

Note: Each **GP-XCOM** is connected using a link cable for controller communication units (**SL-F□**, optional).

When **GP-XCOM** is used, controllers cannot communicate if their software versions are not compatible (Ver. 1.06 or earlier version with Ver 2.00 or later version).

Check the software version and use the correct combination.

FIBER SENSORS

LASER SENSORS

PHOTO-ELECTRIC SENSORS

MICRO PHOTO-ELECTRIC SENSORS

AREA SENSORS

SAFETY LIGHT CURTAINS / SAFETY COMPONENTS

PRESSURE / FLOW SENSORS

INDUCTIVE PROXIMITY SENSORS

PARTICULAR USE SENSORS

SENSOR OPTIONS

SIMPLE WIRE-SAVING UNITS

WIRE-SAVING SYSTEMS

MEASUREMENT SENSORS

STATIC CONTROL DEVICES

LASER MARKERS

PLC

HUMAN MACHINE INTERFACES

ENERGY MANAGEMENT SOLUTIONS

FA COMPONENTS

MACHINE VISION SYSTEMS

UV CURING SYSTEMS

Selection Guide

Laser Displacement

Magnetic Displacement

Contact Displacement

Collimated Beam Sensors

Metal-sheet Double-feed Detection

Digital Panel Controller

Other Products

**GP-X**
**GP-A**

- FIBER SENSORS
- LASER SENSORS
- PHOTO-ELECTRIC SENSORS
- MICRO PHOTO-ELECTRIC SENSORS
- AREA SENSORS
- SAFETY LIGHT CURTAINS / SAFETY COMPONENTS
- PRESSURE / FLOW SENSORS
- INDUCTIVE PROXIMITY SENSORS
- PARTICULAR USE SENSORS
- SENSOR OPTIONS
- SIMPLE WIRE-SAVING UNITS
- WIRE-SAVING SYSTEMS
- MEASURE-MENT SENSORS
- STATIC CONTROL DEVICES
- LASER MARKERS
- PLC
- HUMAN MACHINE INTERFACES
- ENERGY MANAGEMENT SOLUTIONS
- FA COMPONENTS
- MACHINE VISION SYSTEMS
- UV CURING SYSTEMS

## I/O CIRCUIT AND WIRING DIAGRAMS

### NPN output type controller

#### I/O circuit diagram

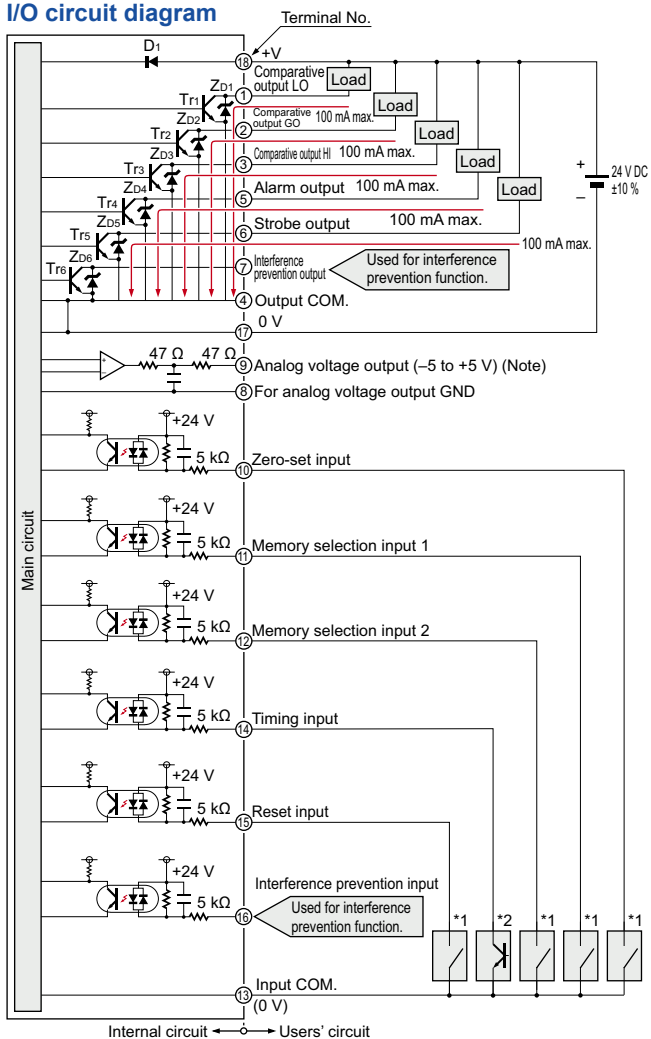

Note: Devices connected to the analog voltage output must have an input impedance set at 1 MΩ or more.

Symbols ... D1: Reverse supply polarity protection diode  
ZD1 to ZD6: Surge absorption zener diode  
Tr1 to Tr6: NPN output transistor

\* 1

Non-voltage contact or NPN open-collector transistor

- Zero-set input, reset input, memory selection input  
Low (0 to 4 V): Effective  
High (+V or open): Ineffective

\* 2

NPN open-collector transistor

- Timing input  
Low (0 to 4 V): Effective  
High (+V or open): Ineffective

#### Memory selection input

Memory No.	Memory selection 1	Memory selection 2
0	High	High
1	Low	High
2	High	Low
3	Low	Low

### PNP output type controller

#### I/O circuit diagram

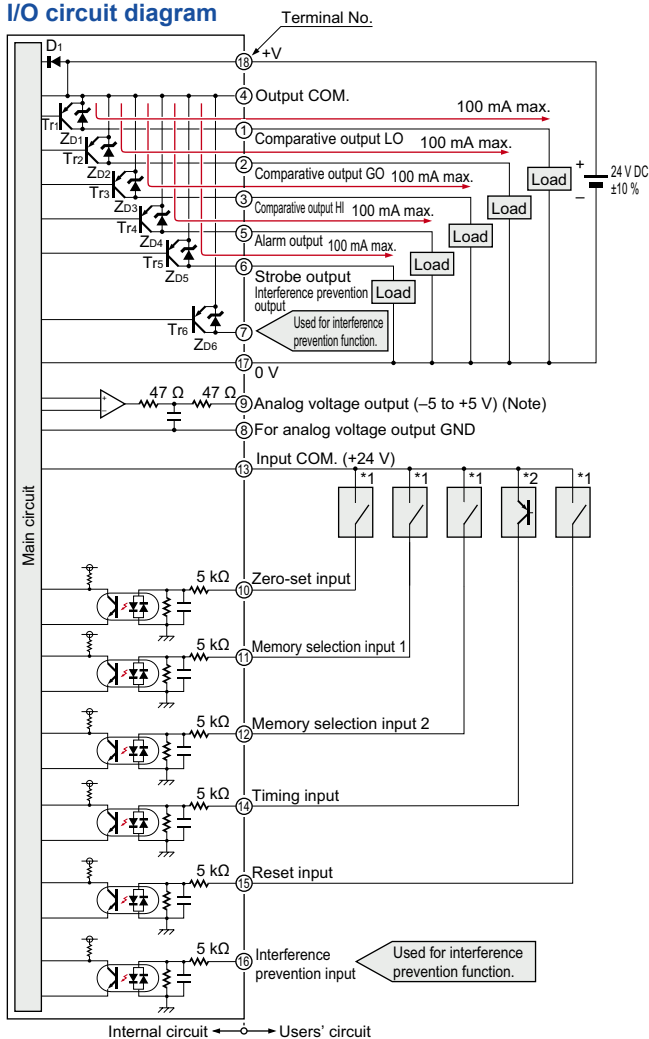

Note: Devices connected to the analog voltage output must have an input impedance set at 1 MΩ or more.

Symbols ... D1: Reverse supply polarity protection diode  
ZD1 to ZD6: Surge absorption zener diode  
Tr1 to Tr6: PNP output transistor

\* 1

Non-voltage contact or PNP open-collector transistor

- Zero-set input, reset input, memory selection input  
Low (0 V or open): Ineffective  
High (+17 or +24 V): Effective

\* 2

PNP open-collector transistor

- Timing input  
Low (0 V or open): Ineffective  
High (+17 to +24 V): Effective

#### Memory selection input

Memory No.	Memory selection 1	Memory selection 2
0	Low	Low
1	High	Low
2	Low	High
3	High	High

## PRECAUTIONS FOR PROPER USE

Refer to p.1595 for general precautions.

FIBER SENSORS

LASER SENSORS

PHOTO-ELECTRIC SENSORS

MICRO PHOTO-ELECTRIC SENSORS

AREA SENSORS

SAFETY LIGHT CURTAINS / SAFETY COMPONENTS

PRESSURE / FLOW SENSORS

INDUCTIVE PROXIMITY SENSORS

PARTICULAR USE SENSORS

SENSOR OPTIONS

SIMPLE WIRE-SAVING UNITS

WIRE-SAVING SYSTEMS

MEASURE-MENT SENSORS

STATIC CONTROL DEVICES

LASER MARKERS

PLC

HUMAN MACHINE INTERFACES

ENERGY MANAGEMENT SOLUTIONS

FA COMPONENTS

MACHINE VISION SYSTEMS

UV CURING SYSTEMS

Selection Guide

Laser Displacement

Magnetic Displacement

Contact Displacement

Collimated Beam Sensors

Metal-sheet Double-feed Detection

Digital Panel Controller

Other Products

**GP-X**
**GP-A**

- Never use this product as a sensing device for personnel protection.
- In case of using sensing devices for personnel protection, use products which meet laws and standards, such as OSHA, ANSI or IEC etc., for personnel protection applicable in each region or country.



- The sensor head and the controller are adjusted in order to conform to the default specification linearity.
- In the event of replacing sensor heads, input the sensor head's characteristic code and conduct 3-point correction (calibration).
- Should you use an extension cable, turn the sensor head cable length selection switch located on the back of the controller to "3 m + 7 m 9.843 ft + 22.966 ft". Then reintroduce the power supply and conduct 3-point correction (calibration).

### Conditions in use for CE conformity

- This product is CE compliant and complies with EMC directives. EN 61000-6-2 is the applicable standard that covers immunities relating to use of this product, but in order to comply with this standard, the following conditions must be satisfied.

#### Conditions

- The controller should be connected less than 10 m **32.808 ft** from the power supply.
- The signal line to connect with the controller should be less than 30 m **98.425 ft**.
- A ferrite clamp must be mounted within 10 mm **0.394 in** from connector fitted onto the **GP-XBCC3** cable with connector on one end for BCD output units.

### Linearity in case of disc-shaped or cylindrical objects

- In case the sensing object is disc-shaped or cylindrical, the linearity varies with the sensing object size. In the event the sensing object is larger than the sizes indicated in the table below, the linearity specification (within  $\pm 0.3\%$  F.S.) is satisfied by performing zero-adjustment and span adjustment when in contact using the scaling function.

#### <In case of disc>

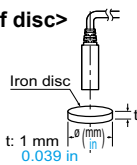

Sensor head	Disc diameter $\phi$ (mm in)	Cylinder diameter $\phi$ (mm in)
GP-X3SE	6 <b>0.236</b>	16 <b>0.630</b>
GP-X5SE	8 <b>0.315</b>	16 <b>0.630</b>
GP-X8S	12 <b>0.472</b>	50 <b>1.969</b>
GP-X10M	12 <b>0.472</b>	50 <b>1.969</b>
GP-X12ML	25 <b>0.984</b>	55 <b>2.165</b>
GP-X22KL	30 <b>1.181</b>	165 <b>6.496</b>

#### <In case of cylinder>

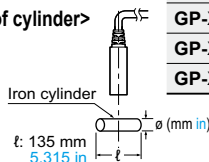

### Mounting sensor head

- The tightening torque should be under the value given below.

#### Mounting with set screw

- Make sure to use an M3 or smaller set screw having a cup-point.

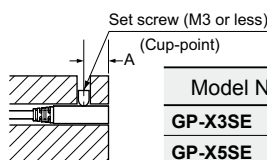

Model No.	A (mm in)	Tightening torque
GP-X3SE	4 to 16 <b>0.157 to 0.630</b>	0.1 N·m or less
GP-X5SE	5 to 16 <b>0.197 to 0.630</b>	0.44 N·m or less
GP-X8S		0.58 N·m or less

#### Mounting with nut

##### <GP-X10M>

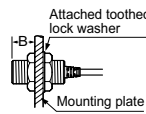

##### <GP-X12ML>

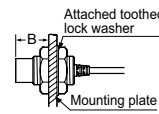

##### <GP-X22KL>

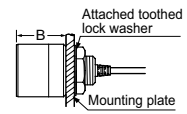

Model No.	B (mm in)	Tightening torque
GP-X10M	7 <b>0.276</b> or more	9.8 N·m or less
GP-X12ML	14 <b>0.551</b> or more	20 N·m or less
GP-X22KL	20 <b>0.787</b> or more (Note 1)	20 N·m or less

Notes: 1) Without nut. If a nut is installed, the dimension will be 23.5 mm **0.926 in** or more.  
2) Mount such that the nuts do not protrude from the threaded portion.

#### Distance from surrounding metal

- As metal around the sensor head may affect the sensing performance, pay attention to the following points.

#### <Embedding of the sensor head in metal>

- Since the analog output may change if the sensor head is completely embedded in metal, keep the minimum distance specified in the table below.

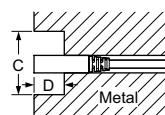

Sensor head	C (mm in)	D (mm in)
GP-X3SE	$\phi 10$ <b>0.394</b>	3 <b>0.118</b>
GP-X5SE		
GP-X8S		
GP-X10M		
GP-X12ML	$\phi 50$ <b>1.969</b>	14 <b>0.551</b>
GP-X22KL	$\phi 50$ <b>1.969</b>	20 <b>0.787</b>

#### Mutual interference

- If several sensor heads are mounted close together, some specifications may not be satisfied. Therefore, proceed with the interference prevention function enabled. The interference prevention function eliminates interference among sensors by alternating sensor oscillations. Contact our office for details about time charts etc. If not using the interference prevention function, leave a distance more than the values given below.

#### <Face to face mounting>

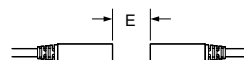

#### <Parallel mounting>

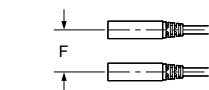

Sensor head	E (mm in)	F (mm in)
GP-X3SE	15 <b>0.591</b>	9 <b>0.354</b>
GP-X5SE	30 <b>1.181</b>	11 <b>0.433</b>
GP-X8S	40 <b>1.575</b>	15 <b>0.591</b>
GP-X10M	40 <b>1.575</b>	15 <b>0.591</b>
GP-X12ML	170 <b>6.693</b>	50 <b>1.969</b>
GP-X22KL	200 <b>7.874</b>	200 <b>7.874</b>

### Sensing range

- The sensing range is specified for the standard sensing object [stainless steel (SUS304) / iron [Cold rolled carbon steel (SPCC)],  $60 \times 60 \times t$  1 mm **2.362 x 2.362 x t 0.039 in**]. For sensing metals other than the standard sensing objects, use the correction coefficient stated below as a guideline. Verify with the actual sensor before using.

#### Correction coefficient

Sensor head	GP-X3SE	GP-X5SE	GP-X8S	GP-X10M	GP-X12ML	GP-X22KL
Metal						
Stainless steel (SUS304), Iron	1					
Aluminum	0.5 approx.					

#### Others

- After turning on the power, wait 15 min. or more [20 min. for the **GP-XC3SE(-P)** and **GP-XC5SE(-P)**] before using the product. The power supply circuit is not stable immediately after the power is turned on, and this may cause measurement values to be distorted. In addition, note that there will also be a muting period of approx. 2 sec.

**DIMENSIONS (Unit: mm in)**

The CAD data can be downloaded from our website.

**Controller**

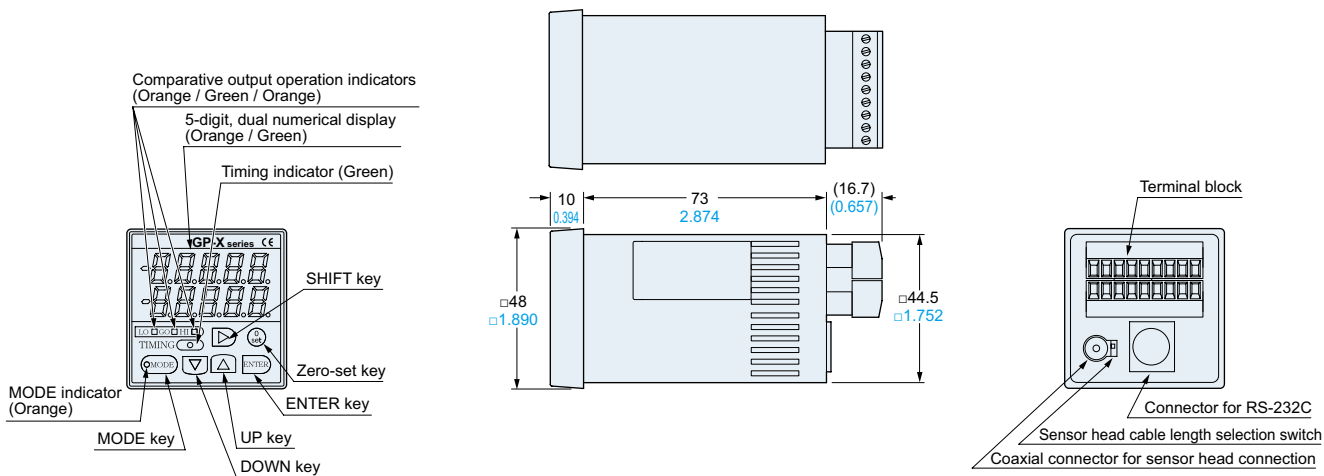

**Panel cut-out dimensions**

<When BCD output unit / controller communication unit not mounted>

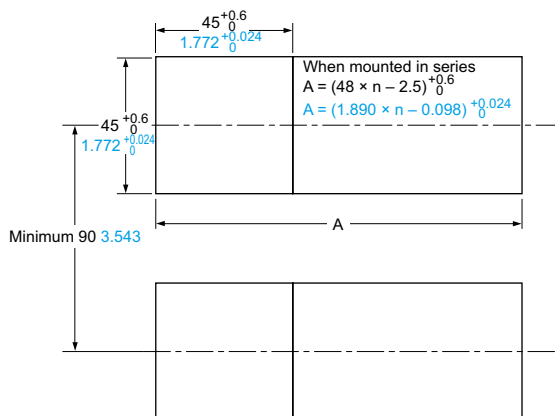

Note: The panel thickness should be 1 to 5 mm 0.039 to 0.197 in.

<When BCD output unit / controller communication unit mounted>

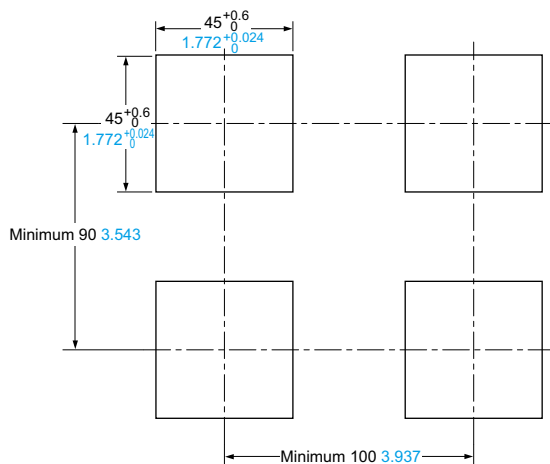

Note: The panel thickness should be 1 to 2.5 mm 0.039 to 0.098 in.

**GP-X3SE**

**Sensor head**

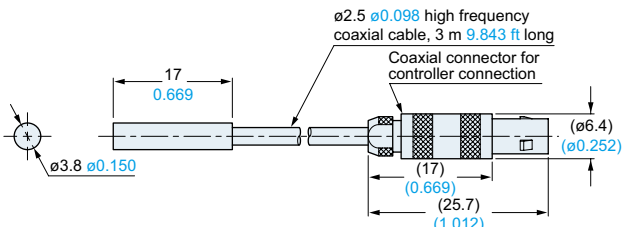

**GP-X5SE**

**Sensor head**

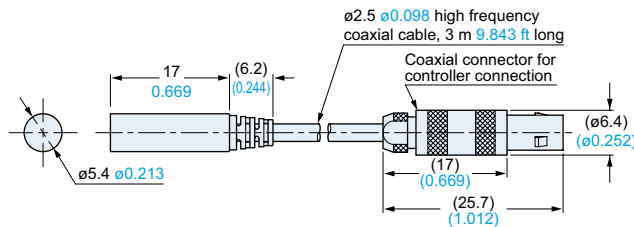

**GP-X8S**

**Sensor head**

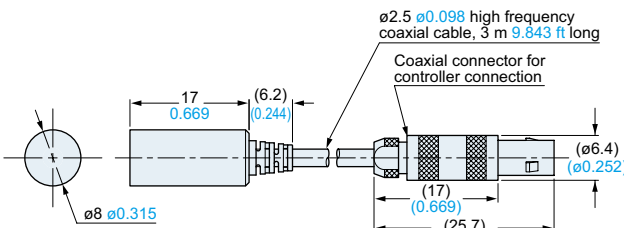

**GP-X10M**

**Sensor head**

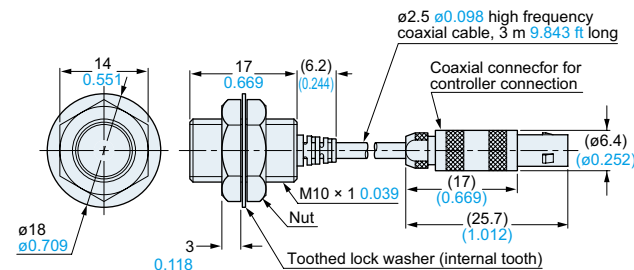

**DIMENSIONS (Unit: mm in)**

The CAD data can be downloaded from our website.

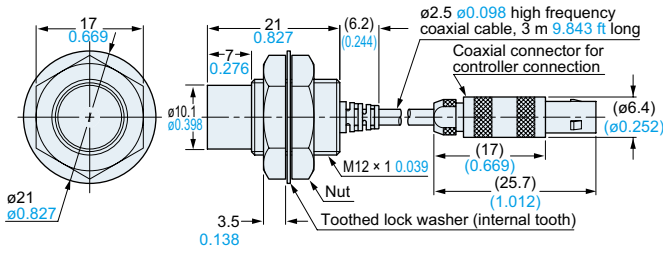
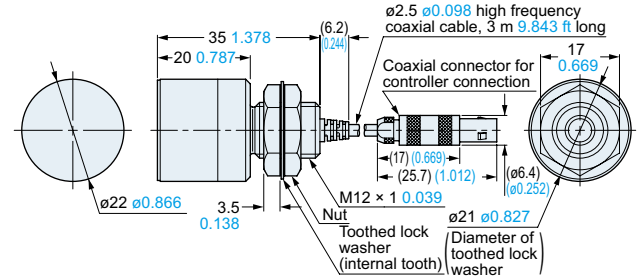
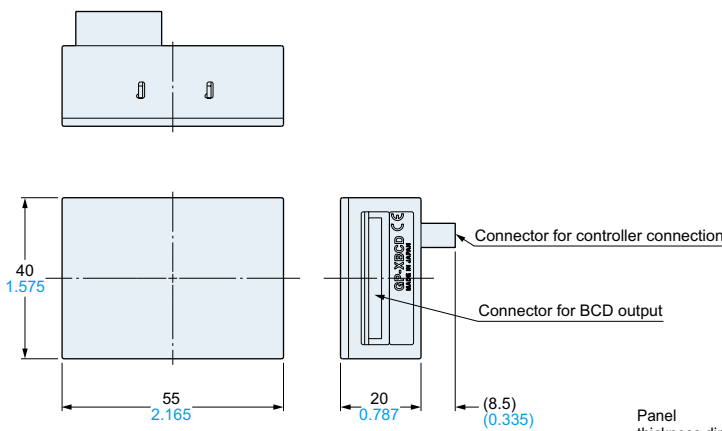
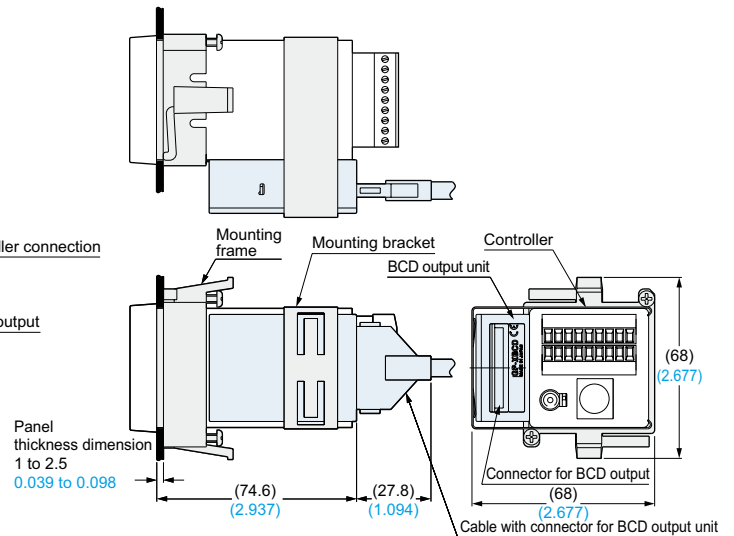
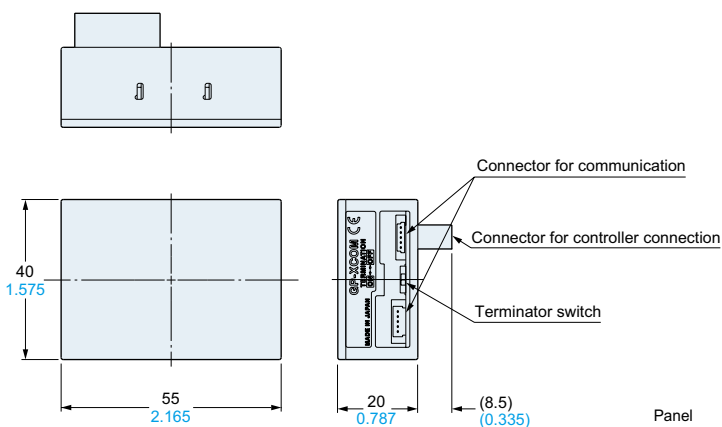
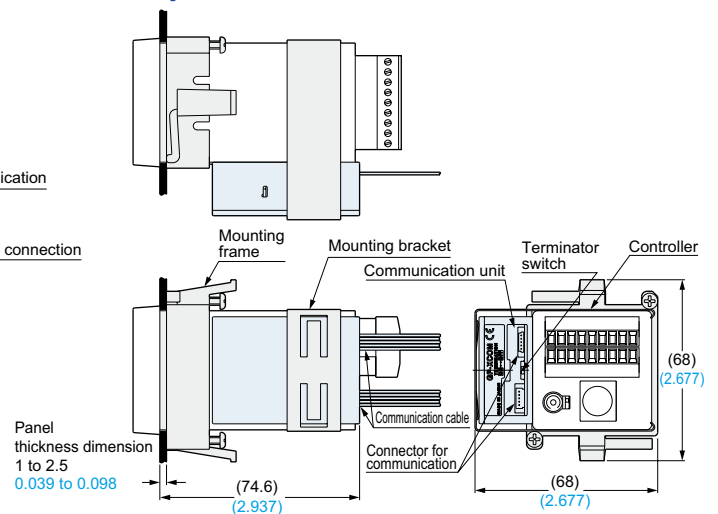
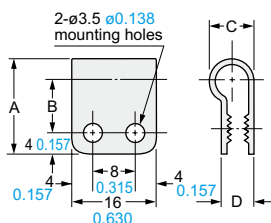
**GP-X12ML**
**Sensor head**

**GP-X22KL**
**Sensor head**

**GP-XBCD**
**BCD output unit (Optional)**

**Assembly dimensions with controller**

**GP-XCOM**
**Controller communication unit (Optional)**

**Assembly dimensions with controller**

**MS-SS3 MS-SS5 MS-SS8**
**Sensor head mounting bracket (Optional)**

Material: Nylon 66

Symbol	Model No.	MS-SS3	MS-SS5	MS-SS8
A		16 0.630	18 0.709	20 0.787
B		9 0.354	10 0.394	11 0.433
C		6.3 0.248	8.3 0.327	10.3 0.406
D		4.9 0.193	6.1 0.240	6.5 0.256
Applicable sensor head model No.		GP-X3SE	GP-X5SE	GP-X8S

FIBER SENSORS

LASER SENSORS

PHOTO-ELECTRIC SENSORS

MICRO PHOTO-ELECTRIC SENSORS

AREA SENSORS

SAFETY LIGHT CURTAINS / SAFETY COMPONENTS

PRESSURE / FLOW SENSORS

INDUCTIVE PROXIMITY SENSORS

PARTICULAR USE SENSORS

SENSOR OPTIONS

SIMPLE WIRE-SAVING UNITS

WIRE-SAVING SYSTEMS

MEASUREMENT SENSORS

STATIC CONTROL DEVICES

LASER MARKERS

PLC

HUMAN MACHINE INTERFACES

ENERGY MANAGEMENT SOLUTIONS

FA COMPONENTS

MACHINE VISION SYSTEMS

UV CURING SYSTEMS

Selection Guide

Laser Displacement

Magnetic Displacement

Contact Displacement

Collimated Beam Sensors

Metal-sheet Double-feed Detection

Digital Panel Controller

Other Products

**GP-X**
**GP-A**