

Importa y distribuye en Argentina:



## GL20-8ADI/GL20-8ADV Analog Input Module Equipment Guide



Industrial  
Automation



New Energy  
Vehicle



Intelligent  
Elevator



Intelligent  
Robot



Digital  
Energy



Rail  
Transit



Data code PS00021870A00

# Legal Information

## Copyright

Copyright © 2025 Shenzhen Inovance Technology Co., Ltd. All rights reserved.

This documentation is the exclusive property of Shenzhen Inovance Technology Co., Ltd. No individual or entity may excerpt, reproduce, modify, translate, or distribute any content herein without written consent from Inovance.

Legal action will be taken against infringement.

## Trademarks

**INOVANCE** is a registered trademark of Shenzhen Inovance Technology Co., Ltd. and its affiliated companies. All other trademarks or registered trademarks mentioned in this documentation are the property of their respective owners. Unauthorized use of these trademarks by third parties for any purpose without written authorization could violate the rights of their owners.

## Disclaimer of Liability

Due to continuous updates and improvements of products and technologies, the content of this documentation may not fully match the actual products. In the event of any discrepancies, the actual products shall prevail.

The contents are subject to change without notice due to product upgrade.

## Waste Disposal

The storage, use, and disposal of this product (including optional accessories) must comply with local laws and regulations.

## Qualified Personnel

The product/system described in this documentation may be operated only by personnel qualified for the specific task in accordance with the relevant documentation, in particular its warning notices and safety instructions. Qualified personnel can identify the risks of the product/system and prevent possible dangers.

## Proper Use of the Product

Proper transportation, storage, assembly, installation, commissioning, operation, and maintenance are required to ensure the safe operation of the product without any problems. The required ambient conditions must be met. All operations must follow the guidelines provided in this documentation.

# Preface

## Introduction

This guide includes the product overview, model and nameplate, components, terminal wiring, as well as technical and environmental specifications of the module.

## Target audience

This guide is primarily intended for the following engineers:

- Business development/Service engineers of Inovance
- Chief technical engineers of channel partners/end users
- Mechanical engineers of channel partners/end users
- Electrical engineers of channel partners/end users
- Software engineers of channel partners/end users
- Maintenance/Service engineers of channel partners/end users

## Documentation guide

The product documentation package is organized into equipment guide and system guide, enabling you to quickly access the information as needed.

- Equipment guide: Contains a brief description of module properties, including model, components, technical specifications, and terminal wiring diagrams.
- System guide: Covers all typical application scenarios of the system, encompassing system introduction, installation, wiring, configuration and commissioning, troubleshooting, and maintenance.

## Standards compliance

The following table lists the certifications, directives, and standards that the product may comply with. For details about the acquired certificates, see the certification marks on the product nameplate.

Certification	Directive		Standard
CE certification	EMC directive	2014/30/EU	<b>24 VDC products:</b> EN 61131-2  <b>220 VAC products:</b> EN 61131-2 EN 61000-3-2 EN 61000-3-3
	LVD directive	2014/35/EU	EN 61010-1 EN 61010-2-201
	RoHS directive	2011/65/EU amended by (EU)2015/863	EN IEC 63000
UL/cUL certification	-		UL 61010-1 UL 61010-2-201 CAN/CSA-C22.2 No. 61010-1 CSA C22.2 NO. 61010-2-201

Certification	Directive		Standard
KCC certification	-		-
EAC certification	-		-
UKCA certification	Safety regulations	Electrical Equipment (Safety) Regulations 2016	EN 61010-1 EN 61010-2-201 EN 61131-2
	EMC Regulations	Electromagnetic Compatibility Regulations 2016	<b>24 VDC products:</b> EN 61131-2 <b>220 VAC products:</b> EN 61131-2 EN 61000-3-2 EN 61000-3-3
	RoHS regulations	Directive (RoHS) Regulations 2012	EN IEC 63000

### More documents

Document	Code	Description
GL20 Series Module System Guide	PS00022010	Covers all typical application scenarios of the system, providing detailed descriptions of system configuration, installation, wiring, commissioning, and troubleshooting.
GL20-8ADI/GL20-8ADV Analog Input Module Equipment Guide (the present guide)	PS00021870	Includes the product overview, model and nameplate, components, terminal wiring, as well as technical and environmental specifications of the module.

### Revision history

Date	Version	Description of changes
2025-12	A00	First release.

### Access to the guide

This guide is not delivered with the product. You can obtain the PDF version in the following ways:

- Visit <https://www.inovance.com/global>, choose Service&Support > Support > Documentation Download.
- Scan the QR code on the product with your smart phone.
- Scan the QR code below to install My Inovance app, where you can search for and download the guide.



## Warranty

Inovance provides warranty service within the warranty period (as specified in your order) for any fault or damage that is caused by proper operation of the user. Maintenance will be charged after the warranty expires.

Even within the warranty period, maintenance will be charged for the following product damage:

- Damage caused by operations not following the instructions in the guide
- Damage caused by fire, flood, or abnormal voltage
- Damage caused by using the product for unintended functions
- Damage caused by using the product outside the specified scope
- Secondary damage caused by force majeure (natural disaster, earthquake, lightning strike)

When applicable, relevant maintenance fee will be charged according to the latest Price List of Inovance. If otherwise agreed upon, the agreed terms and conditions shall prevail.

For details, see the Warranty Card.

# 1 Fundamental Safety Instructions

## 1.1 General Safety Instructions

### Safety disclaimer

1. Read through the safety instructions before installing, operating, and servicing the equipment, and comply with these instructions.
2. To ensure personal and equipment safety, observe the notes indicated on the product labels and all the safety instructions in the user guide.
3. The "CAUTION", "WARNING", and "DANGER" are only supplements to the safety instructions.
4. Use this equipment according to the designated environment requirements. Damage caused by improper use is not covered by warranty.
5. Inovance shall take no responsibility for any personal injury or property damage caused by improper use.

### Safety levels and definitions

**DANGER**

The "DANGER" sign indicates that failure to comply with the notice will result in severe personal injuries or even death.

**WARNING**

The "WARNING" sign indicates that failure to comply with the notice may result in severe personal injuries or even death.

**CAUTION**

Indicates that failure to comply with the notice may result in minor or moderate personal injuries or equipment damage.





#### Unpacking



**WARNING**





- Do not install the equipment if you find damage, rust, or signs of use on the equipment or accessories upon unpacking.
- Do not install the equipment if you find water seepage or missing or damaged components upon unpacking.
- Do not install the equipment if you find the packing list does not conform to the equipment you received.





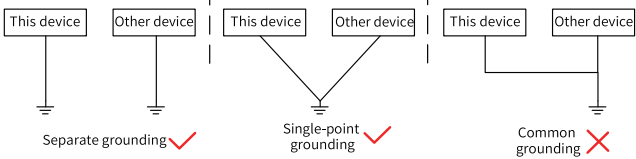

**CAUTION**





- Check whether the packing is intact and whether there is damage, water seepage, dampness, and deformation before unpacking.
- Unpack the package in accordance with the package sequence. Do not hit the package with force.
- Check whether there is damage, rust, or scratches on the surface of the equipment and equipment accessories upon unpacking.
- Check whether the package contents are consistent with the packing list after unpacking.

Storage and transportation	
 WARNING	<ul style="list-style-type: none"> <li>• Large-scale or heavy equipment must be transported by qualified professionals using specialized hoisting equipment. Failure to comply may result in personal injury or equipment damage.</li> <li>• Before hoisting the equipment, ensure the equipment components such as the front cover and terminal blocks are secured firmly with screws. Loosely-connected components may fall off and result in personal injuries or equipment damage.</li> <li>• Never stand or stay below the equipment when the equipment is being hoisted by the hoisting equipment.</li> <li>• When hoisting the equipment with a steel rope, ensure the equipment is hoisted at a constant speed without suffering from vibration or shock. Do not turn the equipment over or let the equipment stay hanging in the air. Failure to comply may result in personal injuries or equipment damage.</li> </ul>
 CAUTION	<ul style="list-style-type: none"> <li>• Handle the equipment with care during transportation and mind your steps to prevent personal injuries or equipment damage.</li> <li>• When carrying the equipment with bare hands, hold the equipment casing firmly with care to prevent parts from falling. Failure to comply may result in personal injuries.</li> <li>• Store and transport the equipment based on the storage and transportation requirements. Failure to comply can result in equipment damage.</li> <li>• Do not store or transport the drive in environments with water splash, rain, direct sunlight, strong electric field, strong magnetic field, and strong vibration.</li> <li>• Do not store the drive for more than three months. Long-term storage requires stricter protection and necessary inspections.</li> <li>• Pack the drive strictly before transportation. Use a sealed box for long-distance transportation.</li> <li>• Never transport the drive with other device or materials that may harm or have negative impacts on the drive.</li> </ul>
Design	
 DANGER	<ul style="list-style-type: none"> <li>• Design a safety circuit and add an error handling program in the software to ensure the product remains in a safe state upon external power failure or product faults.</li> <li>• Add an external fuse or circuit breaker because the module may smoke or catch fire due to long-time overcurrent caused by operation above rated current or load short-circuit.</li> </ul>
 WARNING	<ul style="list-style-type: none"> <li>• When the output units such as relays or transistors in this product are damaged, the output may become uncontrollable and remain continuously ON or OFF.</li> <li>• The product design must comply with the overvoltage category requirements specified in the environmental specifications. The power supply must have a system-level lightning protection device, assuring that overvoltage due to lightning shock cannot be applied to the power supply input terminals, signal input terminals, or output terminals, preventing equipment damage.</li> <li>• Make sure that measures have been taken to avoid malfunction caused by the communication faults between the product and related equipment, preventing personal injury or equipment damage.</li> </ul>
 CAUTION	<p>Do not create, on the touch screen of the HMI, switches that may result in personal injury of the operator or equipment damage . Use independent switches for performing critical operations. Failure to comply may result in accidents caused by wrong outputs or faults.</p>

Installation
<p> <b>DANGER</b></p> <p>The equipment must be operated only by professionals with electrical knowledge. Non-professionals are not allowed.</p>
<p> <b>WARNING</b></p> <ul style="list-style-type: none"><li>• Read through the guide and safety instructions before installation.</li><li>• Do not install this equipment in places with strong electric or magnetic fields.</li><li>• Before installation, ensure that the mechanical strength of the installation site can bear the weight of the equipment. Failure to comply will result in mechanical hazards.</li><li>• Before installation, ensure that the installation environment meets the specifications. Failure to comply will result in product damage.</li><li>• Do not wear loose clothes or accessories during installation. Failure to comply may result in an electric shock.</li><li>• When installing the equipment in a closed environment (such as a cabinet or casing), use a cooling device (such as a fan or air conditioner) to cool the environment down to the required temperature. Failure to comply may result in equipment over-temperature or a fire.</li><li>• Do not retrofit the equipment.</li><li>• Do not fiddle with the bolts used to fix equipment components or the bolts marked in red.</li><li>• The equipment shall be installed in a cabinet or terminal device. Protection measures such as a fireproofing shell, electric protection shell, or mechanical protection shell must be provided for the cabinet or terminal device. The IP level must meet IEC standards and local laws and regulations.</li><li>• Before installing devices with strong electromagnetic interference, such as a transformer, install a shielding device for the equipment to prevent malfunction.</li><li>• Install the equipment onto an incombustible object such as a metal. Keep the equipment away from combustible objects. Failure to comply will result in a fire.</li><li>• For products not supporting hot swapping, disconnect all external power supplies of the system before installing/disassembling the product. Failure to comply may result in electric shock, module fault, or malfunction.</li></ul>
<p> <b>CAUTION</b></p> <ul style="list-style-type: none"><li>• Cover the top of the equipment with a piece of cloth or paper during installation. This is to prevent unwanted objects such as metal chippings, oil, and water from falling into the equipment and causing faults. After installation, remove the cloth or paper on the top of the equipment to prevent over-temperature caused by poor ventilation due to blocked ventilation holes.</li><li>• During installation, ensure the product is connected to the respective connector securely and hook the module firmly. Improper installation may result in malfunction, fault, or fall-off.</li></ul>

Wiring
<div style="border: 1px solid black; padding: 5px; margin-bottom: 10px;">  <b>DANGER</b> </div> <ul style="list-style-type: none"> <li>• The equipment must be operated only by professionals with electrical knowledge. Non-professionals are not allowed.</li> <li>• Before wiring, cut off all the power supplies of the equipment. Wait for at least the time designated on the equipment warning label before further operations because residual voltage still exists after power-off. After waiting for the designated time, measure the DC voltage in the main circuit to ensure the DC voltage is within the safe voltage range. Failure to comply can result in an electric shock.</li> <li>• Do not perform wiring, remove the equipment cover, or touch the circuit board with power on. Failure to comply can result in an electric shock.</li> <li>• Check that the equipment is grounded properly. Failure to comply can result in electric shock. Separate grounding or single-point grounding, other than common grounding, is recommended.</li> </ul> <div style="text-align: center; margin: 10px 0;">  </div> <ul style="list-style-type: none"> <li>• Perform good insulation on terminals so that insulation distance between cables will not reduce after cables are connected to terminals. Failure to comply may result in electric shock or damage to the equipment.</li> <li>• Install the terminal cover attached to the product before power-on or operation after wiring is completed. Failure to comply may result in electric shock.</li> </ul>
<div style="border: 1px solid black; padding: 5px; margin-bottom: 10px;">  <b>WARNING</b> </div> <ul style="list-style-type: none"> <li>• Do not connect the input power supply to the output end of the equipment. Failure to comply will result in equipment damage or even a fire.</li> <li>• Cables used for wiring must meet cross-sectional area and shielding requirements. The shield of the cable must be reliably grounded at one end.</li> <li>• Fix the terminal screws with the tightening torque specified in the user guide. Improper tightening torque may overheat or damage the connecting part, resulting in a fire.</li> <li>• After wiring is done, check that all cables are connected properly and no screws, washers or exposed cables are left inside the equipment. Failure to comply may result in electric shock or equipment damage.</li> </ul>
<div style="border: 1px solid black; padding: 5px; margin-bottom: 10px;">  <b>CAUTION</b> </div> <ul style="list-style-type: none"> <li>• Follow the proper electrostatic discharge (ESD) procedure and wear an anti-static wrist strap to perform wiring. Failure to comply may result in damage to the equipment or to the internal circuit of the product.</li> <li>• Use shielded twisted pairs for the control circuit. Connect the shield to the grounding terminal of the equipment for grounding purpose. Failure to comply will result in equipment malfunction.</li> </ul>
Power-on
<div style="border: 1px solid black; padding: 5px; margin-bottom: 10px;">  <b>DANGER</b> </div> <ul style="list-style-type: none"> <li>• The equipment must be operated only by professionals with electrical knowledge. Non-professionals are not allowed.</li> <li>• Before power-on, check that the equipment is installed and wired properly.</li> <li>• Check that the power supply meets equipment requirements before power-on to prevent equipment damage or a fire.</li> <li>• After power-on, do not open the cabinet door or protective cover of the equipment, touch any terminal, or disassemble any unit or component of the equipment. Failure to comply may result in death or personal injury.</li> </ul>

<b>Power-on</b>
<p> <b>WARNING</b></p> <p>Perform a trial run after wiring to ensure the equipment operates safely. Failure to comply may result in personal injuries or equipment damage.</p>
<b>Operation</b>
<p> <b>DANGER</b></p> <ul style="list-style-type: none"> <li>• The equipment must be operated only by professionals. Failure to comply will result in death or personal injury.</li> <li>• Do not touch any connecting terminals or disassemble any unit or component of the equipment during operation. Failure to comply will result in an electric shock.</li> </ul>
<p> <b>WARNING</b></p> <ul style="list-style-type: none"> <li>• Do not touch the equipment enclosure, fan, or resistor with bare hands. Failure to comply may result in personal injury.</li> <li>• Prevent metal or other objects from falling into the equipment during operation. Failure to comply may result in a fire or equipment damage.</li> <li>• During operation, do not bring live parts into contact with the metal enclosure of the product. Failure to comply may result in a fire or equipment damage.</li> </ul>
<p> <b>CAUTION</b></p> <ul style="list-style-type: none"> <li>• Operate the product strictly within the required environmental conditions. Failure to comply may result in equipment fault or damage.</li> <li>• Touch the HMI panel with hands only during use. Do not use tools to touch the HMI panel. Ino Vance assumes no responsibility for panel damage caused by excessive external force.</li> </ul> <p>Safety recommendations</p> <ul style="list-style-type: none"> <li>• In the position where the operator directly touches the machinery part, for example, where a machinery tool is loaded/unloaded, or where a machine runs automatically, manually-operated devices or similar must be installed independently of the product to start or stop the automatic operation of the system.</li> <li>• If you need to modify the program while the system is running, use the lock function or other protective measures. Ensure that only authorized personnel can make the necessary modifications.</li> </ul>
<b>Battery usage</b>
<p> <b>WARNING</b></p> <ul style="list-style-type: none"> <li>• Do not use batteries that do not meet the product requirements. Failure to comply may result in death, personal injuries, explosion, or fire.</li> <li>• Do not throw batteries into a fire or heat oven. Do not crush or cut the battery. Failure to comply may result in death, personal injuries, explosion, or fire.</li> <li>• Do not expose the battery to extremely high temperatures. Failure to comply may result in death, personal injuries, explosion, or fire.</li> <li>• Do not swallow the battery to prevent the risk of chemical burns.</li> <li>• If a button battery is swallowed by accident, seek medical treatment immediately. Failure to comply may result in severe internal burns within two hours and could result in death.</li> </ul>
<p> <b>CAUTION</b></p> <ul style="list-style-type: none"> <li>• Keep the battery away from children.</li> <li>• If the battery compartment is not shut tight, stop using the device and keep it away from children.</li> </ul>

Maintenance
<p> <b>DANGER</b></p> <ul style="list-style-type: none"> <li>• Maintenance and inspection must be carried out by personnel who have the necessary electrical training and experience.</li> <li>• Do not maintain the equipment with power ON. Failure to comply will result in an electric shock.</li> <li>• Before maintenance, cut off all the power supplies of the equipment and wait for at least the time designated on the equipment warning label.</li> <li>• Disconnect all external power supplies of the system before cleaning the product or re-tightening screws on the terminal block or screws of the connector. Failure to comply may result in electric shock.</li> <li>• Disconnect all external power supplies of the system before removing the product or connecting/removing wirings. Failure to comply may result in electric shock or malfunction.</li> </ul>
<p> <b>WARNING</b></p> <p>Perform routine and periodic inspection and maintenance on the equipment according to maintenance requirements and keep a maintenance record.</p>
Repair
<p> <b>DANGER</b></p> <ul style="list-style-type: none"> <li>• Product repair must be carried out by personnel who have the necessary electrical training and experience.</li> <li>• Do not repair the equipment with power ON. Failure to comply can result in an electric shock.</li> <li>• Before inspection and repair, cut off all the power supplies of the equipment and wait for at least the time designated on the equipment warning label.</li> </ul>
<p> <b>WARNING</b></p> <ul style="list-style-type: none"> <li>• Submit the repair request according to the warranty agreement.</li> <li>• When the fuse is blown or the circuit breaker or earth leakage circuit breaker (ELCB) trips, wait as specified on the product warning sign before power-on or further operations. Failure to comply may result in personal injuries, equipment damage or even death.</li> <li>• When the equipment is faulty or damaged, require professionals to perform troubleshooting and repair by following repair instructions and keep a repair record.</li> <li>• Replace quick-wear parts of the equipment according to the replacement instructions.</li> <li>• Do not use damaged equipment. Failure to comply may result in death, personal injuries, or severe equipment damage.</li> <li>• After the equipment is replaced, check the wiring and set parameters again.</li> </ul>
Disposal
<p> <b>WARNING</b></p> <ul style="list-style-type: none"> <li>• Dispose of retired equipment in accordance with local regulations and standards. Failure to comply may result in property damage, personal injury, or even death.</li> <li>• Recycle retired equipment by observing industry waste disposal standards to avoid environmental pollution.</li> <li>• Dispose of retired batteries as industrial waste according to local laws and regulations.</li> </ul>

## Safety label

For safe equipment operation and maintenance, comply with the safety labels on the equipment. Do not damage or remove the safety labels. The following table describes the meaning of the safety labels.

To ensure safe operation, comply with equipment-related safety labels. The following table describes the meaning of the safety labels.

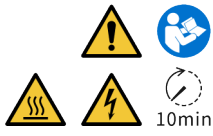
Safety label	Description
	<ul style="list-style-type: none"> <li>• Read through the safety instructions before operating the equipment. Failure to comply may result in death, personal injuries, or equipment damage.</li> <li>• Do not touch the terminals or remove the cover with power ON or within 10 min after power-off. Failure to comply will result in an electric shock.</li> <li>• The surface of the product may become very hot during operation. Do not touch these hot areas, as this may cause burns!</li> </ul>

## 1.2 Industrial Information Security

This product provides an interface to connect to the network and transmit data through the network interface. To protect factories, systems, machines, and networks from cyber attacks, appropriate industrial information security protection mechanisms need to be implemented to ensure the safe operation of factories, systems, machines, and networks.

The customer is responsible for providing and continuously ensuring a secure connection between the product and the customer's network or any other network, to prevent unauthorized access to their factory, systems, machines, and networks. The system or machine may only be connected to the corporate network or the Internet when a secure connection is established and proper security measures are in place (for example, using antivirus software and installing firewalls).

INOVANCE continuously develops and improves its products and solutions to enhance safety. It is strongly recommended that you update your products promptly and always use the latest product versions.

### Caution

Malware (such as viruses, Trojans, and worms) can bring the device into an unsafe operating state, resulting in death, serious injury, and property damage. Observe the following precautions strictly:

- Always use the latest software version. If the product version is no longer supported or the latest program version is not applied, customers are at increased risk of cyberattacks.
- Implement and maintain appropriate security measures (including but not limited to deploying anti-virus software, firewall, WAF, IPS/IDS, situational awareness system, ID verification, and data encryption) to prevent files in the removable storage device from being damaged by malware and to protect products, networks, systems, and interfaces from unauthorized access, disruption, intrusion, data leakage, or information theft.
- Check all safety-related interfaces and settings after commissioning.

## 2 Product Overview

GL20-8ADI is an 8-channel analog current input module, and GL20-8ADV is an 8-channel analog voltage input module. Both of them have a 16-bit resolution and can be used with GL20 series communication interface modules (for example, GL20-RTU-ECT32).

### 3 Model and Nameplate

#### Model

$$\text{GL } \underline{20} \text{ - } \underline{8} \text{ AD} \left\{ \begin{array}{l} \text{I} \\ \text{V} \end{array} \right.$$
  
 ①      ②      ③      ④      ⑤

① <b>Product information</b> GL: General local module	④ <b>Module type</b> AD: Analog input
② <b>Series</b> 20: 20 series module	⑤ <b>Input type</b> • I: Current • V: Voltage
③ <b>Number of I/O channels</b> 8: 8 channels	

#### Nameplate

- GL20-8ADI nameplate information:



INOVANCE

**GL20-8ADI**  
**8 Analog Input Module**

POWER INPUT:DC24V 50mA  
 OUTPUT:NONE

SN:0123456789123456

QC PASSED

IN+	A	1	B	10-	IN-
	10+	1		10-	
	11+	2		11-	
	12+	3		12-	
	13+	4		13-	
	14+	5		14-	
	15+	6		15-	
	16+	7		16-	
	17+	8		17-	
	+24V	9		COM	

MANUAL www.inovance.com  
 Suzhou Inovance Technology Co., Ltd. Made in China

- GL20-8ADV nameplate information:

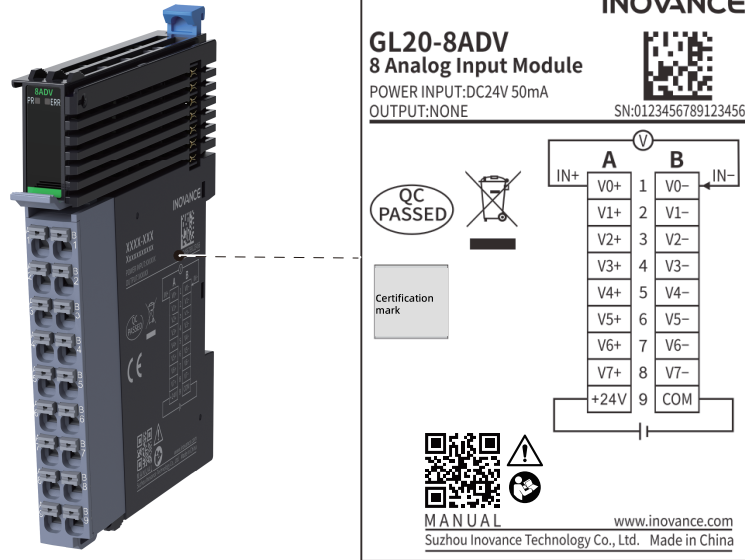





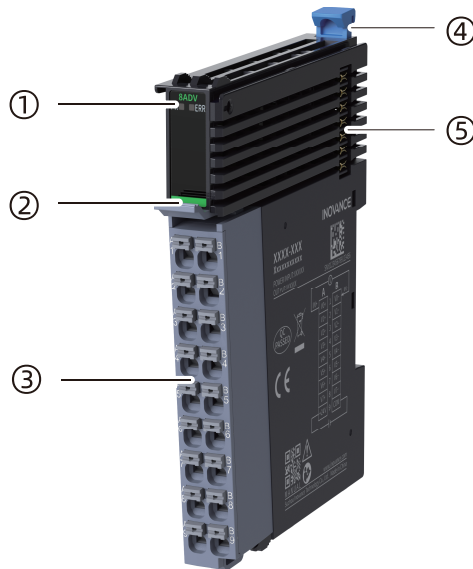

Based on the above model and nameplate information, relevant ordering information of the product is provided in the following table.

Model	Description	Product code	Applicable model
GL20-8ADI-INT	GL20 series 8-channel analog current input module	01441092	GL20 series communication interface modules (for example, GL20-RTU-ECT32)
GL20-8ADV-INT	GL20 series 8-channel analog voltage input module	01441086	

## 4 Component

Only components of GL20-8ADV are described below, because the components of GL20-8ADI and GL20-8ADV are identical.



No.	Name	Description			
①	Signal indicator	PR (POWER +RUN)	Power/Operation indicator	Yellow-green	ON when the module is in normal operation.
		ERR	State machine error indicator	Red	ON when an error occurs in the state machine.
②	Color identification	 Red: Digital output	 Orange: Analog output		
		 Gray: Digital input	 Green: Analog input		
		 White: Communication	 Blue: Other modules		
③	Push-in terminal block	Plug-in terminal block with spring clamp and silkscreen marking "AB". For details, see <a href="#">"5.1 Terminal Assignment" on page 16</a>			
④	Rail mounting latch	Used to secure the module to the DIN rail.			
⑤	Three-position terminal block	Used for backplane bus power supply and communication.			

## 5 Terminal Wiring

### 5.1 Terminal Assignment

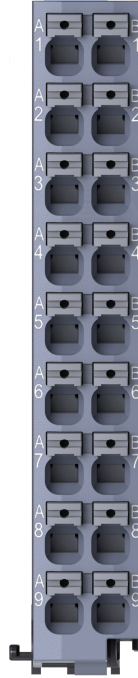

- GL20-8ADI

Signal (left)	Terminal (left)	Terminal (right)	Signal (right)
I0+	A1	B1	I0-
I1+	A2	B2	I1-
I2+	A3	B3	I2-
I3+	A4	B4	I3-
I4+	A5	B5	I4-
I5+	A6	B6	I5-
I6+	A7	B7	I6-
I7+	A8	B8	I7-
24 V	A9	B9	COM

- GL20-8ADV

Signal (left)	Terminal (left)	Terminal (right)	Signal (right)
V0+	A1	B1	V0-
V1+	A2	B2	V1-
V2+	A3	B3	V2-
V3+	A4	B4	V3-
V4+	A5	B5	V4-
V5+	A6	B6	V5-
V6+	A7	B7	V6-
V7+	A8	B8	V7-
24 V	A9	B9	COM

## 5.2 Wiring Diagram

This section includes the circuit block diagrams, wiring methods (two-/three-/four-wire), and wiring precautions for the GL20-8ADI/GL20-8ADV analog input module. Different wiring methods can be used and combined for different channels.

### Precautions

- Do not bundle the extension cables with power cables (high voltage and high current) that produce strong interference signals, as this may increase noise, surges, and induction effects. Separate the extension cables from the power cables and avoid cabling in parallel.
- Use the recommended cables and adapter boards for connection. It is recommended that shielded cables be used as extension cables to enhance anti-interference capacity.
- Apply single-point grounding for the shield of shielded cables and soldered cables.

### Circuit wiring diagram for GL20-8ADI

- Two-wire connection

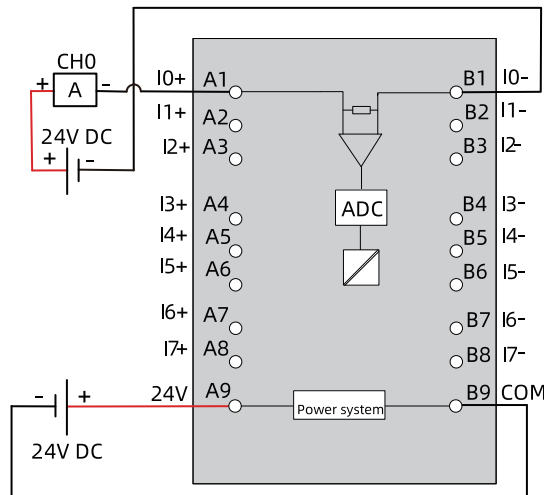

- Three-wire connection

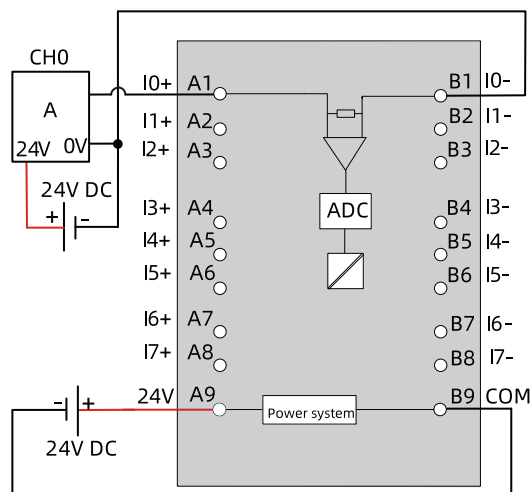

- Four-wire connection

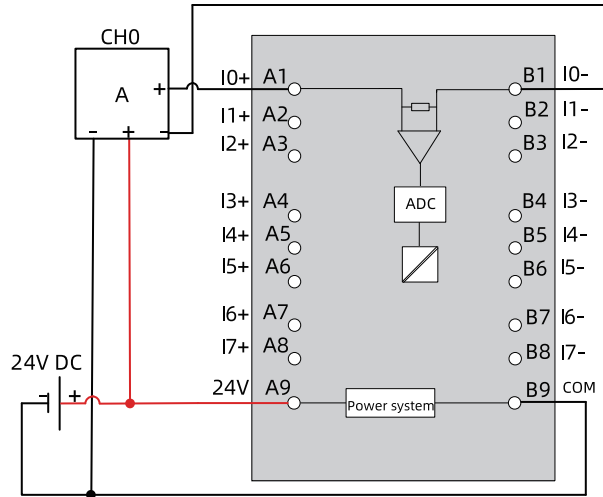

### Circuit wiring diagram for GL20-8ADV

- Three-wire connection

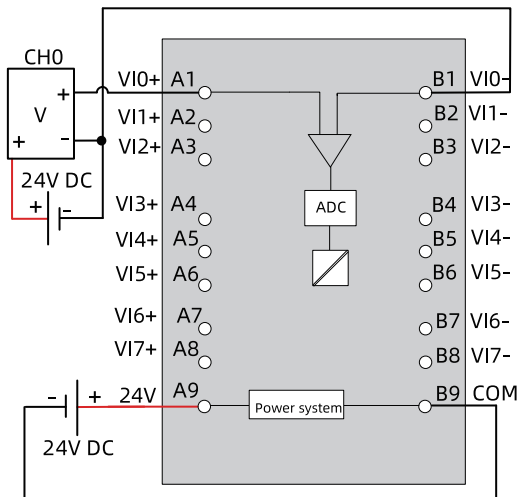

- Four-wire connection

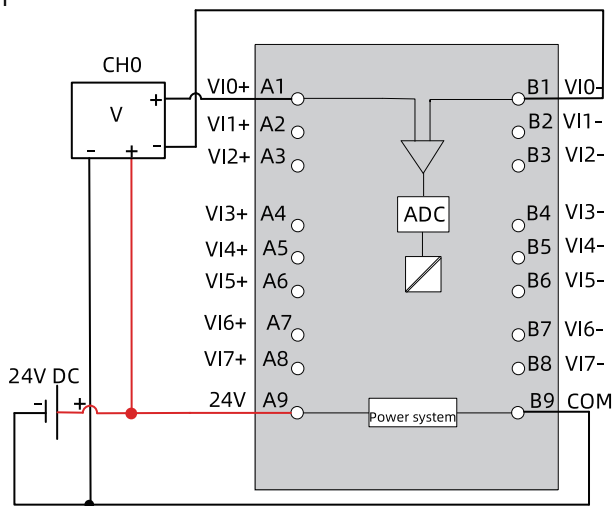

## 6 Technical Specifications

### Mechanical specifications

Item	Description
IP rating	IP20
Dimensions (W x H x D)	12 mm x 100 mm x 75 mm
Weight	Approx. 60 g

### Power supply specifications

Item	Description
Rated bus input voltage	5 VDC (4.75 VDC to 5.25 VDC)
Rated bus input current	65 mA (typical@5 V)
Rated terminal input voltage	24 VDC (20.4 VDC to 28.8 VDC)
Rated terminal input current	50 mA (typical@24 V)
Rated terminal output voltage	None
Rated terminal output current	None

### Input specifications

Item	Description	
Input type	Analog input	
Input mode	<ul style="list-style-type: none"> <li>• GL20-8ADI: Current input</li> <li>• GL20-8ADV: Voltage input</li> </ul>	
Number of input channels	8	
Resolution	16-bit	
Conversion time	250 $\mu$ s/channel	
GL20-8ADI	Current input range	$\pm 20$ mA, 0 mA to 20 mA, 4 mA to 20 mA
	Current sampling impedance	90 $\Omega$
	Current input accuracy (25°C)	$\pm 0.2\%$ (full range)
	Current input accuracy (full temperature range)	$\pm 0.4\%$ (full range)
	Current input limit	$\pm 30$ mA (transient), $\pm 24$ mA (average), 50 mA (peak withstand current)
	Current input diagnosis	Wire break detection supported only when the current input is set to 4 mA to 20 mA
GL20-8ADV	Voltage input range	$\pm 10$ V, 0 V to 10 V, $\pm 5$ V, 0 V to 5 V, 1 V to 5 V
	Voltage input impedance	> 100 k $\Omega$
	Voltage input accuracy (25°C)	$\pm 0.2\%$ (full range)
	Voltage input accuracy (full temperature range)	$\pm 0.4\%$ (full range)
	Voltage input limit	$\pm 15$ V
	Voltage input diagnosis	Wire break detection supported only when the voltage input is set to 1 V to 5 V <sup>[1]</sup>
Isolation	No isolation between the channels; isolation between the interfaces and the power supply; isolation between the interfaces and the bus	

Item	Description
Input status display	None
Input derating	None

### Note

[1]: Disconnection detection is available only when the "Offline Sign" parameter is enabled. To ensure proper functioning of the disconnection detection feature, it is recommended to use a sensor with an independent power supply.

### Software specifications

Item	Description	
Input PDO data size	Max. 16 bytes	
Independent channel configuration	Supported	
Diagnostic reporting function	Supported	
GL20-8ADI	Diagnostic detection configuration	Wire break detection supported only when the input is set to 4 mA to 20 mA
	Conversion mode configuration	± 20 mA, 0 mA to 20 mA, 4 mA to 20 mA
GL20-8ADV	Diagnostic detection configuration	Wire break detection supported only when the input is set to 1 V to 5 V
	Conversion mode configuration	± 10 V, 0 V to 10 V, ± 5 V, 0 V to 5 V, 1 V to 5 V
Filter parameter configuration	Filtering strength: 0 to 255, default 8, unitless	
Overflow configuration	Supported	
Overlimit detection configuration	Supported	
Peak hold configuration	Supported	
Digital range conversion configuration	-20000 to +20000, -32000 to +32000, -27648 to +27648	
Sampling cycle	125 µs/channel supported, 1 ms/8 channels not configurable	
Sampling refresh mode	Asynchronous refresh according to the sampling time, instead of synchronous refresh according to the bus cycle	
Output in the stop mode	Output last value, without further refreshing	
Channel configuration modification during operation	Supported	

## 7 环境规格

Item	Specification
Installation/Operating environment	Free from conductive dust, conductive fibers, explosive dust, flammable gases, water mist/greasy dirt, corrosive dusts/gases, strong vibration, and repetitive shock
Altitude	≤ 2000 m
Pollution degree	Level 2
Immunity	2 kV on power supply line (Conforms to IEC 61000-4-4)
Overvoltage category	I
EMC immunity level	Zone B, IEC61131-2
Anti-static rating	Contact discharge +/- 6 kV and air discharge +/- 8 kV
Vibration resistance	<ul style="list-style-type: none"> <li>• Application scenario: Tested according to IEC60068-2-6. 3.5 mm amplitude at 5 Hz to 8.4 Hz; 1 g acceleration at 8.4 Hz to 200 Hz; 10 cycles per axis.</li> <li>• Transportation scenario: Tested according to IEC60068-2-64, 0.01 g<sup>2</sup>/Hz power spectral density at 5 Hz to 100 Hz; 0.001 g<sup>2</sup>/Hz power spectral density at 200Hz; 1.14 g G<sub>rms</sub></li> </ul>
Shock resistance	Application/Transportation scenario: Tested according to IEC60068-2-27; 15 g peak acceleration, 11 ms pulse width, 18 shocks in total in X, Y and Z axes
Operating temperature/humidity	<ul style="list-style-type: none"> <li>• Temperature: -20°C to +55°C</li> <li>• Humidity: &lt; 95% RH (30°C), without condensation</li> </ul>
Storage temperature/humidity	<ul style="list-style-type: none"> <li>• Temperature: -20°C to +60°C</li> <li>• Humidity: &lt; 95% RH (30°C), without condensation</li> </ul>
Transportation temperature/humidity	<ul style="list-style-type: none"> <li>• Temperature: -40°C to +70°C</li> <li>• Humidity: &lt; 95% RH (40°C), without condensation</li> </ul>

## 8 List of Spare Parts

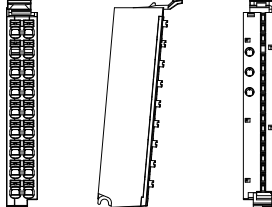
Name	Description	Product Code	Diagram
Push-in terminal block (marked as AB)	Pluggable terminal block with spring clamp wiring	15212496	

## 9 Dimension Drawing

The dimensions (in mm) are shown in the figure below.

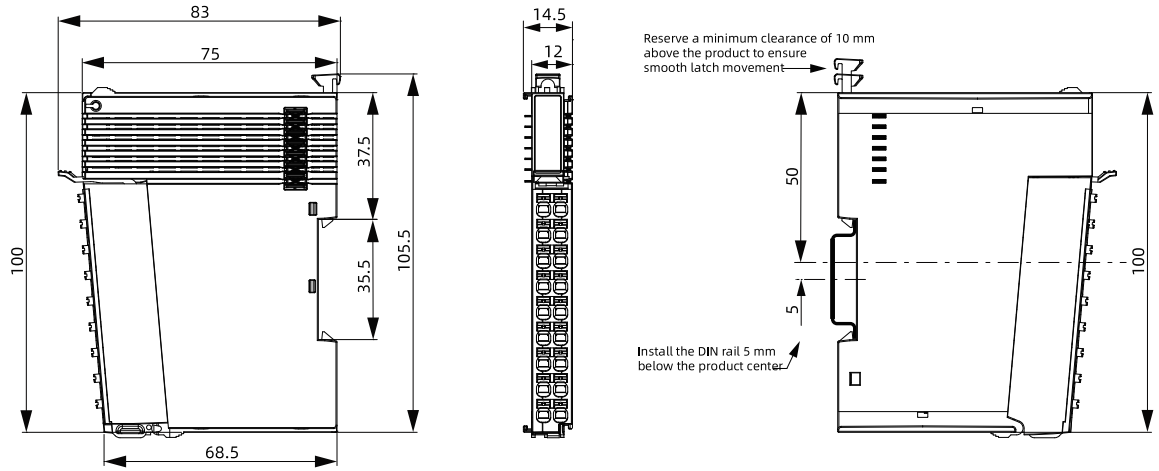

## Service and Support

Should you encounter a safety accident during the use or operation of the product, or face challenges in operating and maintaining the equipment, which remain unresolved after the relevant documentation is consulted, we provide multiple channels to ensure prompt resolution:

- Channel #1: Contact [service@inovance.com](mailto:service@inovance.com).



- Channel #2: Visit <https://www.inovance.com/global> to access document downloads, after-sales support, spare parts ordering, repair applications, and authenticity verification services.
- Channel #3: Download My Inovance app (<https://zshc-eu.inovance.com/download-pc/>) where you can access products info and documentation, and query product parameters.

We are committed to providing you with quick and professional technical support, and we look forward to your satisfaction and trust.



Copyright © Shenzhen Inovance Technology Co., Ltd.

PS00021870A00

**Importa y distribuye en Argentina:**

**ECFA**

**ECFA S.R.L.**

 Av. San Juan 4063 (C1233ABK) - Buenos Aires - Argentina

 +54 11 4923-6566

 [ventas@ecfa.com.ar](mailto:ventas@ecfa.com.ar)

 <https://www.ecfa.com.ar>

---

**Shenzhen Inovance Technology Co., Ltd.**

[www.inovance.com](http://www.inovance.com)

---

**Suzhou Inovance Technology Co., Ltd.**

[www.inovance.com](http://www.inovance.com)

---

Add.: Inovance Headquarters Tower, High-tech Industrial Park,  
Guanlan Street, Longhua New District,  
Shenzhen 518000, P.R. China

Tel: (0755) 2979 9595

Fax: (0755) 2961 9897

---

Add.: No. 52, Tian E Dang Road, Wuzhong District, 215104,  
Suzhou City, Jiangsu Province, P.R. China

Tel: (0512) 6637 6666

Fax: (0512) 6285 6720