

Importa y distribuye en Argentina:

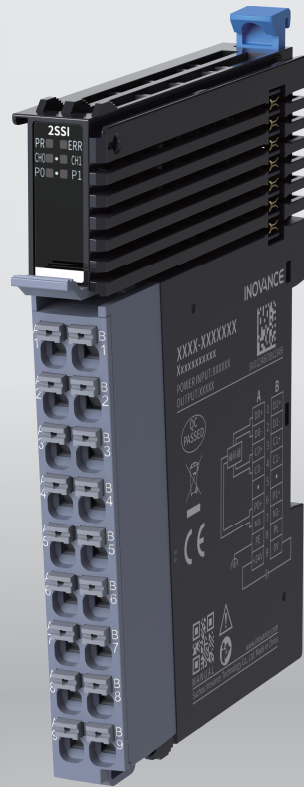

GL20-2SSI 2-Channel Encoder Input Module Equipment Guide



Industrial
Automation



New Energy
Vehicle



Intelligent
Elevator



Intelligent
Robot



Digital
Energy



Rail
Transit



Data code PS00021904A00

Legal Information

Copyright

Copyright © 2025 Shenzhen Inovance Technology Co., Ltd. All rights reserved.

This documentation is the exclusive property of Shenzhen Inovance Technology Co., Ltd. No individual or entity may excerpt, reproduce, modify, translate, or distribute any content herein without written consent from Inovance.

Legal action will be taken against infringement.

Trademarks

INOVANCE is a registered trademark of Shenzhen Inovance Technology Co., Ltd. and its affiliates. All other trademarks or registered trademarks mentioned in this documentation are the property of their respective owners. Unauthorized use of these trademarks by third parties for any purpose without written authorization could violate the rights of their owners.

Disclaimer of Liability

Due to continuous updates and improvements of products and technologies, the content of this documentation may not fully match the actual products. In the event of any discrepancies, the actual products shall prevail.

The contents are subject to change without notice due to product upgrade.

Waste Disposal

The storage, use, and disposal of this product (including optional accessories) must comply with local laws and regulations.

Qualified Personnel

The product/system described in this documentation may be operated only by personnel qualified for the specific task in accordance with the relevant documentation, in particular its warning notices and safety instructions. Qualified personnel can identify the risks of the product/system and prevent possible dangers.

Proper Use of the Product

Proper transportation, storage, assembly, installation, commissioning, operation, and maintenance are required to ensure the safe operation of the product without any problems. The required ambient conditions must be met. All operations must follow the guidelines provided in this documentation.

Preface

Introduction

This guide describes the product overview, model and nameplate specifications, component descriptions, terminal wiring, as well as technical and environmental specifications of the module.

Target audience

This guide is primarily intended for the following engineers:

- Inovance development/service engineers
- Channel/End-user chief technical engineers
- Channel/End-user mechanical engineers
- Channel/End-user electrical engineers
- Channel/End-user software engineers
- Channel/End-user maintenance/service engineers

Documentation guide

The product documentation package consists of an equipment guide and a system guide, enabling users to quickly access the information they need.

- Equipment guide: Provides a brief overview of module attributes, including model descriptions, component descriptions, technical specifications, and terminal wiring diagrams.
- System guide: Covers all typical application scenarios of the system, encompassing system introduction, installation, wiring, configuration and commissioning, troubleshooting, and maintenance.

Standards compliance

The following table lists the certifications, directives, and standards that the product may comply with. For details about the acquired certificates, see the certification marks on the product nameplate.

Certification	Directive		Standards compliance
CE certification	EMC directive	2014/30/EU	24 VDC products: EN 61131-2 220 VAC products: EN 61131-2 EN 61000-3-2 EN 61000-3-3
	LVD directive	2014/35/EU	EN 61010-1 EN 61010-2-201
	RoHS directive	2011/65/EU amended by (EU)2015/863	EN IEC 63000
UL/cUL certification	-		UL 61010-1 UL 61010-2-201 CAN/CSA-C22.2 No. 61010-1 CSA C22.2 NO. 61010-2-201

Certification	Directive		Standards compliance
KCC certification	-		-
EAC certification	-		-
UKCA certification	Safety regulations	Electrical Equipment (Safety) Regulations 2016	EN 61010-1 EN 61010-2-201
	EMC regulations	Electromagnetic Compatibility Regulations 2016	24 VDC products: EN 61131-2 220 VAC products: EN 61131-2 EN 61000-3-2 EN 61000-3-3
	RoHS regulations	Directive (RoHS) Regulations 2012	EN IEC 63000

More documents

Document	Code	Description
GL20 Series Module System Guide	PS00022010	This guide covers all typical application scenarios of the system, providing detailed instructions on system configuration, installation, wiring, commissioning, troubleshooting.
GL20-2SSI 2-Channel Encoder Input Module Equipment Guide (This guide)	PS00021904	This guide describes the product overview, model and nameplate specifications, component descriptions, terminal wiring, as well as technical and environmental specifications of the module.

Revision history

Revision date	Version	Description of change(s)
December 2025	A00	First release

Access to the guide

This guide is not delivered with the product. You can obtain the PDF version in the following ways:

- Visit <https://www.inovance.com/global>, choose Service&Support > Support > Documentation Download.
- Scan the QR code on the product with your smart phone.
- Scan the QR code below to install My Inovance app, where you can search for and download the guide.



Warranty disclaimer

Inovance provides warranty service within the warranty period (as specified in your order) for any fault or damage that is not caused by improper operation of the user. Maintenance fees will be charged after the warranty period expires.

Within the warranty period, maintenance fee will be charged for the following damage:

- Damage caused by operations not following the instructions in the user guide
- Damage caused by fire, flood, or abnormal voltage
- Damage caused by using the product for unintended functions
- Damage caused by using the product outside the specified scope
- Damage or secondary damage caused by force majeure (natural disaster, earthquake, and lightning strike)

The maintenance fee will be charged according to the latest Price List of Inovance. If otherwise agreed upon, the terms and conditions in the agreement shall prevail.

For details, see Product Warranty Card.

1 Fundamental Safety Instructions

1.1 General Safety Instructions

Safety disclaimer

1. Read through the safety instructions before installing, operating, and servicing the equipment, and comply with these instructions.
2. To ensure personal and equipment safety, observe the notes indicated on the product labels and all the safety instructions in the user guide.
3. The "CAUTION", "WARNING", and "DANGER" are only supplements to the safety instructions.
4. Use this equipment according to the designated environment requirements. Damage caused by improper use is not covered by warranty.
5. Inovance shall take no responsibility for any personal injury or property damage caused by improper use.

Safety levels and definitions



DANGER

The "DANGER" sign indicates that failure to comply with the notice will result in severe personal injuries or even death.



WARNING

The "WARNING" sign indicates that failure to comply with the notice may result in severe personal injuries or even death.



CAUTION

The "CAUTION" sign indicates that failure to comply with the notice may result in minor or moderate personal injury or equipment damage.

Unpacking







WARNING



- Do not install the equipment if you find damage, rust, or signs of use on the equipment or accessories upon unpacking.
- Do not install the equipment if you find water seepage or missing or damaged components upon unpacking.
- Do not install the equipment if you find the packing list does not conform to the equipment you received.



CAUTION

- Check whether the packing is intact and whether there is damage, water seepage, dampness, and deformation before unpacking.
- Unpack the package in accordance with the unpacking sequence. Do not hit the package with force.
- Check whether there is damage, rust, or scratches on the surface of the equipment and equipment accessories upon unpacking.
- Check whether the package contents are consistent with the packing list after unpacking.

Storage and transportation
<p> WARNING</p> <ul style="list-style-type: none"> • Large-scale or heavy equipment must be transported by qualified professionals using specialized hoisting equipment. Failure to comply may result in personal injury or equipment damage. • Before hoisting the equipment, ensure that components such as the front cover and terminal blocks are secured firmly with screws. Loosely-connected components may fall off and result in personal injury or equipment damage. • Never stand or stay below the equipment when the equipment is being hoisted by the hoisting equipment. • When hoisting the equipment with a steel rope, ensure the equipment is hoisted at a constant speed without suffering from vibration or shock. Do not turn the equipment over or let the equipment stay hanging in the air. Failure to comply may result in personal injury or equipment damage.
<p> CAUTION</p> <ul style="list-style-type: none"> • Handle the equipment with care during transportation and mind your step to prevent personal injury or equipment damage. • When carrying the equipment with bare hands, hold the equipment casing firmly with care to prevent parts from falling. Failure to comply may result in personal injury. • Store and transport the equipment based on the storage and transportation requirements. Failure to comply can result in equipment damage. • Do not store or transport the drive in environments with water splash, rain, direct sunlight, strong electric field, strong magnetic field, and strong vibration. • Do not store the drive for more than three months. Long-term storage requires stricter protection and necessary inspections. • Pack the drive strictly before transportation. Use a sealed box for long-distance transportation. • Never transport the drive with other device or materials that may harm or have negative impacts on the drive.
Design
<p> DANGER</p> <ul style="list-style-type: none"> • Design a safety circuit and add an error handling program in the software to ensure the product remains in a safe state upon external power failure or product faults. • Add an external fuse or circuit breaker because the module may smoke or catch fire due to long-time overcurrent caused by operation above rated current or load short-circuit.
<p> WARNING</p> <ul style="list-style-type: none"> • When the output units such as relays or transistors in this product are damaged, the output may become uncontrollable and remain continuously ON or OFF. • The product design must comply with the overvoltage category requirements specified in the environmental specifications. The power supply must have a system-level lightning protection device, assuring that overvoltage due to lightning shock cannot be applied to the power supply input terminals, signal input terminals, or output terminals, preventing equipment damage. • Make sure that measures have been taken to avoid malfunction caused by the communication faults between the product and related equipment, preventing personal injury or equipment damage.
<p> CAUTION</p> <p>Do not create, on the touch screen of the HMI, switches that may result in personal injury of the operator or equipment damage . Use independent switches for performing critical operations. Failure to comply may result in accidents caused by wrong outputs or faults.</p>

Installation
<p> DANGER</p> <p>The equipment must be operated only by professionals with electrical knowledge. Non-professionals are not allowed.</p>
<p> WARNING</p> <ul style="list-style-type: none">• Read through the guide and safety instructions before installation.• Do not install this equipment in places with strong electric or magnetic fields.• Before installation, ensure that the mechanical strength of the installation site can bear the weight of the equipment. Failure to comply will result in mechanical hazards.• Before installation, ensure that the installation environment meets the specifications. Failure to comply will result in product damage.• Do not wear loose clothes or accessories during installation. Failure to comply may result in electric shock.• When installing the equipment in a closed environment (such as a cabinet or casing), use a cooling device (such as a fan or air conditioner) to cool the environment down to the required temperature. Failure to comply may result in equipment over-temperature or a fire.• Do not retrofit this product.• Never loosen the fixing bolts on components and modules, or any bolts marked in red.• The equipment shall be installed in a cabinet or terminal device. Protection measures such as a fireproofing shell, electric protection shell, or mechanical protection shell must be provided for the cabinet or terminal device. The IP level must meet IEC standards and local laws and regulations.• Before installing devices with strong electromagnetic interference, such as a transformer, install a shielding device for the equipment to prevent malfunction.• Install the equipment onto an incombustible object such as a metal. Keep the equipment away from combustible objects. Failure to comply will result in a fire.• For products not supporting hot swapping, disconnect all external power supplies of the system before installing/removing the product. Failure to comply may result in electric shock, module fault, or malfunction.
<p> CAUTION</p> <ul style="list-style-type: none">• Cover the top of the product with a piece of cloth or paper during installation. This is to prevent unwanted objects such as metal chippings, oil, and water from falling into the product and causing faults. After installation, remove the cloth or paper on top of the product to prevent over-temperature caused by poor ventilation due to blocked ventilation holes.• During installation, ensure the product is connected to the respective connector securely and hook the module firmly. Improper installation may result in malfunction, fault, or fall-off.

Wiring



- The equipment must be operated only by professionals with electrical knowledge. Non-professionals are not allowed.
- Before wiring, switch off all power supplies of the device. Wait for at least the time designated on the equipment warning label before further operations because residual voltage still exists after power-off. Measure the DC voltage of the main circuit and make sure that it is below the safety voltage. Failure to comply can result in the risk of electric shock.
- Do not perform wiring, remove the equipment cover, or touch the circuit board with power on. Failure to comply can result in the risk of electric shock.
- Make sure that the equipment and product are grounded properly. Failure to comply can result in the risk of electric shock. Ground the equipment separately or to a single point. Common grounding must not be used.

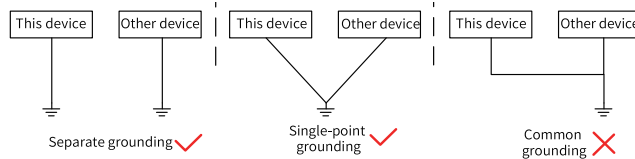

- Perform good insulation on terminals so that insulation distance between cables will not reduce after cables are connected to terminals. Failure to comply may result in electric shock or damage to the equipment.
- Install the terminal cover attached to the product before power-on or operation after wiring is completed. Failure to comply may result in electric shock.



- Never connect the power cable to output terminals of the equipment or product. Failure to comply may damage the equipment or even cause a fire.
- Cables used for wiring comply with the requirements for the cross sectional area and shielding. The shielding layer of the shielded cable must be reliably grounded at one end.
- Fix the terminal screws with the tightening torque specified in the user guide. Insufficient or excessive torque may cause overheating and damage of the joint, which could result in a fire.
- After wiring is done, check that all cables are connected properly and no screws, washers or exposed cables are left inside the equipment. Failure to comply may result in electric shock or equipment damage.













- Follow the proper electrostatic discharge (ESD) procedure and wear an anti-static wrist strap to perform wiring. Failure to comply may result in damage to the equipment or to the internal circuit of the product.
- Use shielded twisted pairs for the control circuit. Connect the shield to the grounding terminal of the equipment for grounding purpose. Failure to comply will result in equipment malfunction.

Power-on



- The equipment must be operated only by professionals with electrical knowledge. Non-professionals are not allowed.
- Before power-on, check that the equipment is installed and wired properly.
- Check that the power supply meets equipment requirements before power-on to prevent equipment damage or a fire.
- After power-on, do not open the cabinet door or protective cover of the equipment, touch any terminal, or disassemble any unit or component of the equipment. Failure to comply may result in death or personal injury.

Power-on
<p> WARNING</p> <p>Perform a trial run after wiring to ensure the equipment operates safely. Failure to comply may result in personal injury or equipment damage.</p>
Operation
<p> DANGER</p> <ul style="list-style-type: none">• The equipment must be operated only by professionals. Failure to comply can result in personal injury or death.• Do not touch any connecting terminals or disassemble any unit or component of the equipment during operation. Failure to comply can result in electric shock.
<p> WARNING</p> <ul style="list-style-type: none">• Do not touch the equipment enclosure, fan, or resistor with bare hands. Failure to comply may result in personal injury.• Prevent metal or other objects from falling into the equipment during operation. Failure to comply may result in a fire or equipment damage.• During operation, do not bring live parts into contact with the metal enclosure of the product. Failure to comply may result in a fire or equipment damage.
<p> CAUTION</p> <ul style="list-style-type: none">• Operate the product strictly within the required environmental conditions. Failure to comply may result in equipment fault or damage.• Touch the HMI panel with hands only during use. Do not use tools to touch the HMI panel. Ino Vance assumes no responsibility for panel damage caused by excessive external force. <p>Safety recommendations</p> <ul style="list-style-type: none">• In the position where the operator directly touches the machinery part, for example, where a machinery tool is loaded/unloaded, or where a machine runs automatically, manually-operated devices or similar must be installed independently of the product to start or stop the automatic operation of the system.• If you need to modify the program while the system is running, use the lock function or other protective measures. Ensure that only authorized personnel can make the necessary modifications.
Battery usage
<p> WARNING</p> <ul style="list-style-type: none">• Do not use batteries that do not meet the product requirements. Failure to comply may result in death, personal injury, explosion, or fire.• Do not throw batteries into a fire or heat oven. Do not crush or cut the battery. Failure to comply may result in death, personal injury, explosion, or fire.• Do not expose the battery to extremely high temperatures. Failure to comply may result in death, personal injury, explosion, or fire.• Do not swallow the battery to prevent the risk of chemical burns.• If a button battery is swallowed by accident, seek medical treatment immediately. Failure to comply may result in severe internal burns within two hours and could result in death.
<p> CAUTION</p> <ul style="list-style-type: none">• Keep the battery away from children.• If the battery compartment is not shut tight, stop using the device and keep it away from children.

Maintenance
<p> DANGER</p> <ul style="list-style-type: none"> • Maintenance and inspection must be carried out by personnel who have the necessary electrical training and experience. • Do not maintain the equipment with power ON. Failure to comply can result in electric shock. • Before maintenance, cut off all the power supplies of the equipment and wait for at least the time designated on the equipment warning label. • Disconnect all external power supplies of the system before cleaning the product or re-tightening screws on the terminal block or screws of the connector. Failure to comply may result in electric shock. • Disconnect all external power supplies of the system before removing the product or connecting/removing wirings. Failure to comply may result in electric shock or malfunction.
<p> WARNING</p> <p>Perform routine and periodic inspection and maintenance on the equipment according to maintenance requirements and keep a maintenance record.</p>
Repair
<p> DANGER</p> <ul style="list-style-type: none"> • Product repair must be carried out by personnel who have the necessary electrical training and experience. • Do not repair the equipment with power ON. Failure to comply can result in electric shock. • Before inspection and repair, cut off all the power supplies of the equipment and wait for at least the time designated on the equipment warning label.
<p> WARNING</p> <ul style="list-style-type: none"> • Submit the repair request according to the warranty agreement. • When the fuse is blown or the circuit breaker or earth leakage circuit breaker (ELCB) trips, wait as specified on the product warning sign before power-on or further operations. Failure to comply may result in personal injuries, equipment damage or even death. • When the equipment is faulty or damaged, require professionals to perform troubleshooting and repair by following repair instructions and keep a repair record. • Replace quick-wear parts of the equipment according to the replacement instructions. • Do not use damaged equipment. Failure to comply may result in death, personal injury, or severe equipment damage. • After the equipment is replaced, check the wiring and set parameters again.
Disposal
<p> WARNING</p> <ul style="list-style-type: none"> • Dispose of retired equipment in accordance with local regulations and standards. Failure to comply may result in property damage, personal injury, or even death. • Recycle retired equipment by observing industry waste disposal standards to avoid environmental pollution. • Dispose of retired batteries as industrial waste according to local laws and regulations.

Safety Label

For safe equipment operation and maintenance, comply with the safety labels on the equipment. Do not damage or remove the safety labels. The following table describes the meaning of the safety labels.

To ensure safe operation, comply with equipment-related safety labels. The following table describes the meaning of the safety labels.

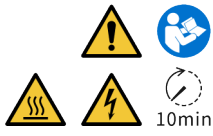
Safety Label	Description
	<ul style="list-style-type: none"> • Read through the safety instructions before operating the equipment. Failure to comply may result in death, personal injuries, or equipment damage. • Do not touch the terminals or remove the cover with power ON or within 10 min after power-off. Failure to comply will result in an electric shock. • The surface of the product may become very hot during operation. Do not touch these hot areas, as this may cause burns!

1.2 Industrial Information Security

The product provides interfaces for network connection and data transmission. To protect factories, systems, machines, and networks from cyber attacks, it is essential to implement proper protection mechanism for industrial security.

Customers are responsible for providing and maintaining a secure connection between the product and their network or any other network to protect their factories, systems, machines, and networks from unauthorized access. Such systems or machines can be connected to an enterprise network or the Internet only when a secure connection is established and appropriate security measures (such as using antivirus software or installing firewalls) are in place.

Inovance continuously develops and improves its products and solutions to make them secure. It is strongly recommended that you update the product promptly and always use the latest version.

Caution

Malware (such as viruses, Trojans, and worms) can bring the device into an unsafe operating state, resulting in death, serious injury, and property damage. Observe the following precautions strictly:

- Always use the latest software version. If the product version is no longer supported or the latest program version is not applied, customers are at increased risk of cyberattacks.
 - Implement and maintain appropriate security measures (including but not limited to deploying anti-virus software, firewall, WAF, IPS/IDS, situational awareness system, ID verification, and data encryption) to prevent files in the removable storage device from being damaged by malware and to protect products, networks, systems, and interfaces from unauthorized access, disruption, intrusion, data leakage, or information theft.
 - Check all safety-related interfaces and settings after commissioning.
-

2 Product Introduction

GL20-2SSI (Synchronous Serial Interface) is a 2-channel encoder input module that connects SSI absolute encoders to a controller, enabling the controller to process periodically sampled encoder values.

It has the following features:

- Standardization of SSI absolute encoder data frames (i.e. SSI data frames).
- Selectable reverse mode to adjust the motion direction of the SSI absolute encoder to the rotation direction of the motion axis.
- Configurable encoding type for SSI absolute encoders (Gray code/binary code).
- Flexible configuration of SSI absolute encoder bit length (10 to 32 bits) for compatibility with a wide range of encoders.
- Parity check support.
- Wide baud rate setting range for SSI absolute encoders (0.1 MHz to 2 MHz).
- Flexible monoflop time setting (interval between consecutive frames).
- Multiple sampling mode support (It can only be activated when the frame interval is 512 μ s or 1024 μ s.)

3 Model and Nameplate

Model

GL 20 - 2 SSI

① ② ③ ④

① Product information	③ Number of channels
GL: General local module	2: Two channels
② Series	④ Module type
20: 20 series module	SSI: Encoder input module

Nameplate

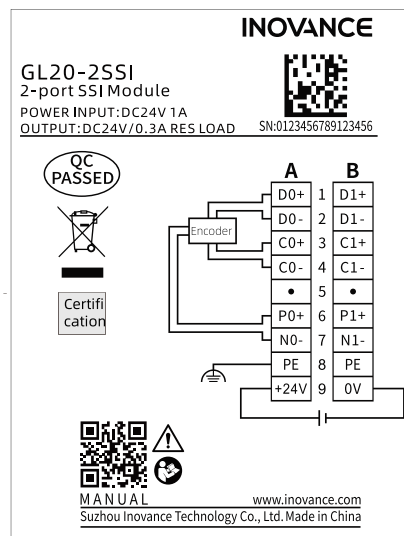





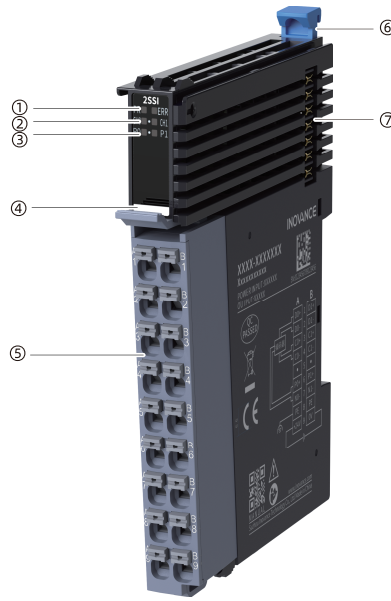

Based on the above naming rules and nameplate information, the relevant ordering data of the product is provided in the following table.

Model	Description	Product code	Applicable model
GL20-2SSI-INT	GL20 series SSI communication module	01441056	Applicable to GL20 series communication interface modules, such as GL20-RTU-ECT32

4 Components



No.	Name	Description			
①	Signal indicator	PR (POWER +RUN)	Power/Operation indicator	Yellow- green	<ul style="list-style-type: none"> • Steady ON: The module is in normal operation. • Fast flashing: The module is addressed successfully. • Slow flashing: The module is powered on but not addressed. • OFF: The module is not powered on or is faulty.
		ERR	Fault indicator	Red	Module fault
②	Encoder indicator	CH0/CH1	SSI0/SSI1 encoder active	Yellow- green	<ul style="list-style-type: none"> • ON: Encoder active • OFF: Encoder inactive
③	Power supply indicator	P0/P1	SSI0/SSI1 encoder 24 V power supply	Yellow- green	<ul style="list-style-type: none"> • ON: 24 V power active • OFF: 24 V power inactive
④	Color identification	 Red: Digital output	 Orange: Analog output		
		 Gray: Digital input	 Green: Analog input		
		 White: Communication	 Blue: Other modules		
⑤	PUSH IN terminal	Pluggable terminal block with spring clamp wiring. The terminal block features "AB" silkscreen marking. For detailed definitions, see "5.1 Terminal Assignment" on page 15			
⑥	Rail mounting latch	Used to secure the module to the DIN rail.			
⑦	Three-position terminal block	Used for backplane bus power supply and communication.			

Note

- Fast flashing: The indicator is on for 200 ms and off for 50 ms, cycling continuously.
- Slow flashing: The indicator is on for 200 ms and off for 1 s, cycling continuously.

5 Terminal Wiring

5.1 Terminal Assignment



Left display	Left signal	Left terminal	Right terminal	Right signal	Right display
SS10 differential data positive	D0+	A1	B1	D1+	SS11 differential data positive
SS10 differential data negative	D0-	A2	B2	D1-	SS11 differential data negative
SS10 differential clock positive	C0+	A3	B3	C1+	SS11 differential clock positive
SS10 differential clock negative	C0-	A4	B4	C1-	SS11 differential clock negative
Not connected	NC	A5	B5	NC	Not connected
SS10 24V+	P0+	A6	B6	P1+	SS11 24V+
SS10 0V+	N0-	A7	B7	N1-	SS11 0V+
Protective earth	PE	A8	B8	PE	Protective earth
Module power supply input +	24 V	A9	B9	0 V	Module power supply input -

5.2 Wiring Diagram

Wiring precautions

- Do not bundle the extension cables with power cables (high voltage and high current) that produce strong interference signals, as this may increase noise, surges, and induction effects. Separate the extension cables from the power cables and avoid cabling in parallel.
- Use the recommended cables and adapter boards for connection. It is recommended that shielded cables be used as extension cables to enhance anti-interference capacity.
- Apply single-point grounding for the shield of shielded cables and soldered cables.

Circuit wiring diagram

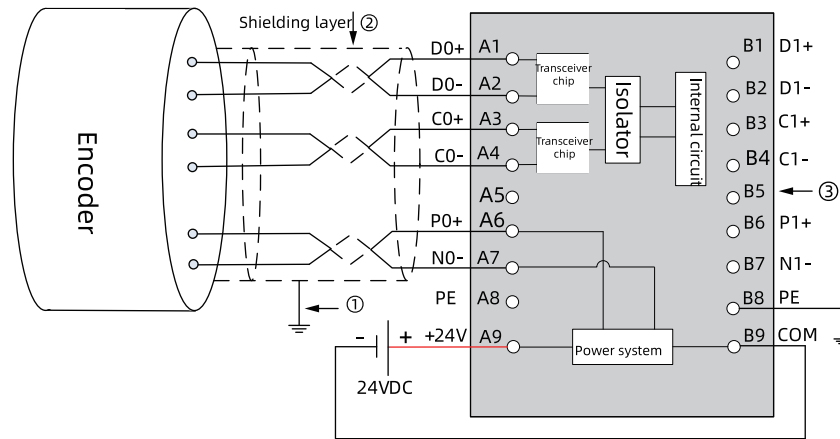

No.	Description
①	The shielding layer must maintain a good connection with the PE (if connected to the PE of the SSI module, it is recommended that the PE be properly grounded externally via cables).
②	Use the shielded twisted pair cable as the encoder cable.
③	Terminals A5 and B5 are not connected and have no electrical function.

Note

Wiring requirement:

- Use the shielded twisted pair cable as the encoder cable.
- The PE terminal of the SSI module must be well grounded through a cable.

When the on-site environment is harsh or the encoder has abnormal data:

- Add a magnetic ring to the shield cable near the module terminals.
- For encoder shielded cables, grounding the shield at both ends is recommended.

6 Technical Specifications

Mechanical specifications

Item	Specification
IP rating	IP20
Dimensions (W x H x D)	12 mm x 100 mm x 75 mm
Weight	Approx. 61 g

Power supply specifications

Item	Specification
Rated bus input current	115 mA
Rated terminal input voltage	24 VDC (20.4 VDC to 28.8 VDC)
Rated terminal input current	1 A
Module hot-swap	Not supported
Reverse polarity protection for 24 V input	Supported
Terminal power output channels	Two channels
Rated terminal output voltage	24 VDC (20.4 VDC to 28.8 VDC)
Rated terminal output current	300 mA per channel
Terminal output power protection	<ul style="list-style-type: none"> • Overcurrent protection: In the event of a short circuit or overcurrent, the internal circuit will self-lock to provide protection. • Short-circuit diagnosis: After the protection is activated, the circuit sends a low-level signal to the microcontroller to indicate the protection state. • Protection unlock: Once the circuit is self-locked, the microcontroller must send an unlock signal to restore power output.
Isolation from the input power supply	No
Isolation between two power supplies	No

Interface specifications

Item	Specification
Number of channels	Two channels
Interface type	SSI
Channel interface signal	<ul style="list-style-type: none"> • SSI output: 2, clock output (C+, C-) • SSI input: 2, data input (D+, D-)
SSI signal voltage	5 V
Output voltage	2 x 24 V

Item	Specification
Baud rate and transmission distance	100 kHz - 200 m 200 kHz - 120 m 300 kHz - 100 m 400 kHz - 80 m 500 kHz - 60 m 1 MHz - 25 m 1.25 MHz - 20 m 1.5 MHz - 15 m 2 MHz - 10 m Default: 500 kHz - 60 m
Matching resistor	120 Ω matching resistor provided at the receiving end of the SSI data signal inside the module
Isolation mode	Digital isolation from internal logic signals
Diagnostic reporting function	Supported
Independent channel configuration	Supported (24 V short-circuit diagnosis, communication fault diagnosis, data frame error diagnosis)
Action taken upon encoder disconnection	Encoder output value set to 0
Signal type	Binary/Gray code Default: Gray code
Data type	Adjustable length: 10 bits to 32 bits Default: 25 bits
Reverse identification	ON/OFF
Parity check	None/Odd/Even

7 Environmental Specifications

Item	Specification
Installation/Operating environment	Free from conductive dust, conductive fibers, explosive dust, flammable gases, water mist/greasy dirt, corrosive dusts/gases, strong vibration, and repetitive shock
Altitude	≤ 2000 m
Pollution degree	Level 2
Immunity	2 kV on power supply line (Conforms to IEC 61000-4-4)
Overvoltage category	I
EMC immunity level	Zone B, IEC61131-2
Anti-static rating	Contact discharge +/-6 kV and air discharge +/-8 kV
Vibration resistance	<ul style="list-style-type: none"> • Application scenario: Tested according to IEC60068-2-6. 3.5 mm amplitude at 5 Hz to 8.4 Hz; 1 g acceleration at 8.4 Hz to 200 Hz; 10 cycles per axis. • Transportation scenario: Tested according to IEC60068-2-64, 0.01 g²/Hz power spectral density at 5 Hz to 100 Hz; 0.001 g²/Hz power spectral density at 200Hz; 1.14 g G_{rms}
Shock resistance	Application/Transportation scenario: Tested according to IEC60068-2-27; 15 g peak acceleration, 11 ms pulse width, 18 shocks in total in X, Y and Z axes
Operating temperature/humidity	<ul style="list-style-type: none"> • Temperature: -20°C to +55°C • Humidity: < 95% RH (30°C), without condensation
Storage temperature/humidity	<ul style="list-style-type: none"> • Temperature: -20°C to +60°C • Humidity: < 95% RH (30°C), without condensation
Transportation temperature/humidity	<ul style="list-style-type: none"> • Temperature: -40°C to +70°C • Humidity: < 95% RH (40°C), without condensation

8 Spare Parts List

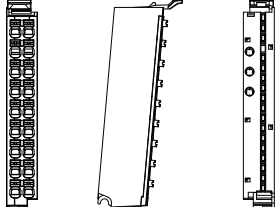
Name	Description	Product Code	Diagram
Push-in terminal block (marked as AB)	Pluggable terminal block with spring clamp wiring	15212496	

9 Dimension Drawing

The dimensions (in mm) are shown in the figure below.

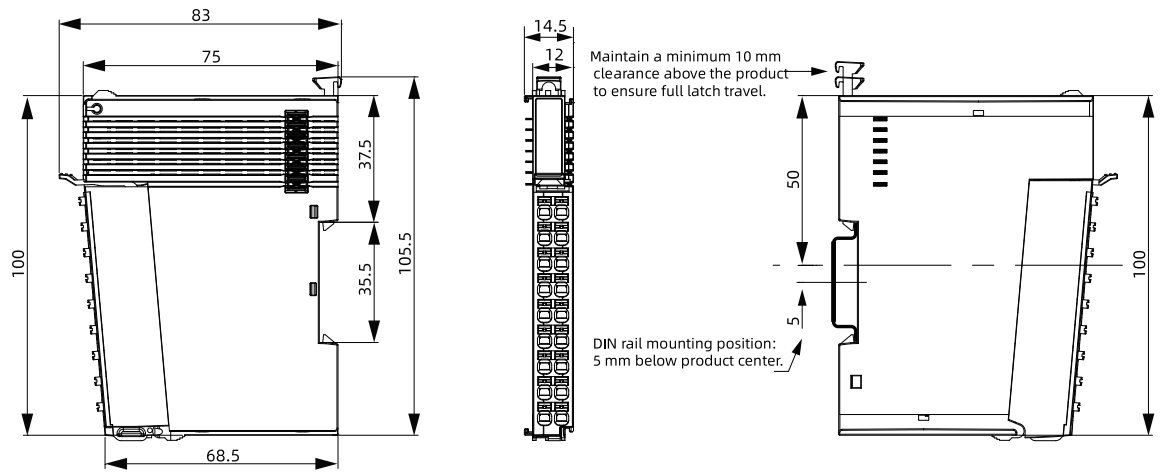

Service and Support

Should you encounter a safety accident during the use or operation of the product, or face challenges in operating and maintaining the equipment, which remain unresolved after the relevant documentation is consulted, we provide multiple channels to ensure prompt resolution:

- Channel #1: Contact service@inovance.com.
- Channel #2: Visit <https://www.inovance.com/global> to access document downloads, after-sales support, spare parts ordering, repair applications, and authenticity verification services.
- Channel #3: Download My Inovance app (<https://zshc-eu.inovance.com/download-pc/>) where you can access products info and documentation, and query product parameters.

We are committed to providing you with quick and professional technical support, and we look forward to your satisfaction and trust.



PS00021904A00

Copyright © Shenzhen Inovance Technology Co., Ltd.

Importa y distribuye en Argentina:

ECFA

ECFA S.R.L.

 Av. San Juan 4063 (C1233ABK) - Buenos Aires - Argentina

 +54 11 4923-6566

 ventas@ecfa.com.ar

 <https://www.ecfa.com.ar>

Shenzhen Inovance Technology Co., Ltd.

www.inovance.com

Suzhou Inovance Technology Co., Ltd.

www.inovance.com

Add.: Inovance Headquarters Tower, High-tech Industrial Park,
Guanlan Street, Longhua New District,
Shenzhen 518000, P.R. China

Tel: (0755) 2979 9595

Fax: (0755) 2961 9897

Add.: No. 52, Tian E Dang Road, Wuzhong District, 215104,
Suzhou City, Jiangsu Province, P.R. China

Tel: (0512) 6637 6666

Fax: (0512) 6285 6720