

G2150E2 HMI

Kinco

Installation Instruction

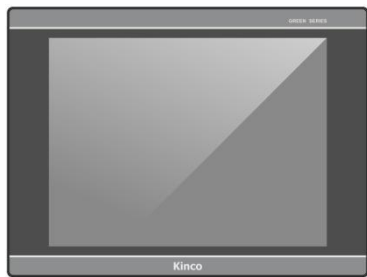

Kinco Electric (Shenzhen) Ltd.

Add: Building 1, No. 6 Langshan 1st Rd, Hi-tech Park North, Nanshan, Shenzhen, China.
Tel: 0755-26585555 Fax: 0755-26616372 http://www.kinco.cn Email: sales@kinco.cn

1. Installation Note

1.1 Environmental Requirement

Operating temperature: G2150E2 HMI can work stably in most industrial environments that the temperature between 32°F to 122°F (0~50°C).
NEMA rating: This Series HMI frontpanel is NEMA 1 rated.

Please do not use in the following places:

- Places direct in sunlight
- Surrounding temperature and humidity beyond the specifications
- Places of temperature changes sharply and easily cause condensation
- Places that exist corrosive gas and combustible gas
- Places of much dust, dirt, salt and iron powder
- Places that will be splashed water, oil and drugs
- Places that bring direct vibration and shock to host

Please take shielding measures in the following places:

- Places that exist electrostatic or other kinds of noise
- Places of strong electromagnetic
- Places that may be exposed to rays
- Places near the power

1.2 Power Requirement

- Input voltage: DC10 V~DC28V.
- Particularly note that there must be enough distance between this product and converters or switch mode power supply. Make sure that the input and output cables of that kind equipment are shield cable and the shielding network is connected with the ground.
- Make sure that the DC power and AC power is isolated.
- Do not use common power with perceptual load or input circuit of the controller.

Note: An Internal fuse will prevent damage for over voltage condition, however it isn't guaranteed the internal electronic components are not damaged.

2. Installation Description

2.1 Dimensional Drawing

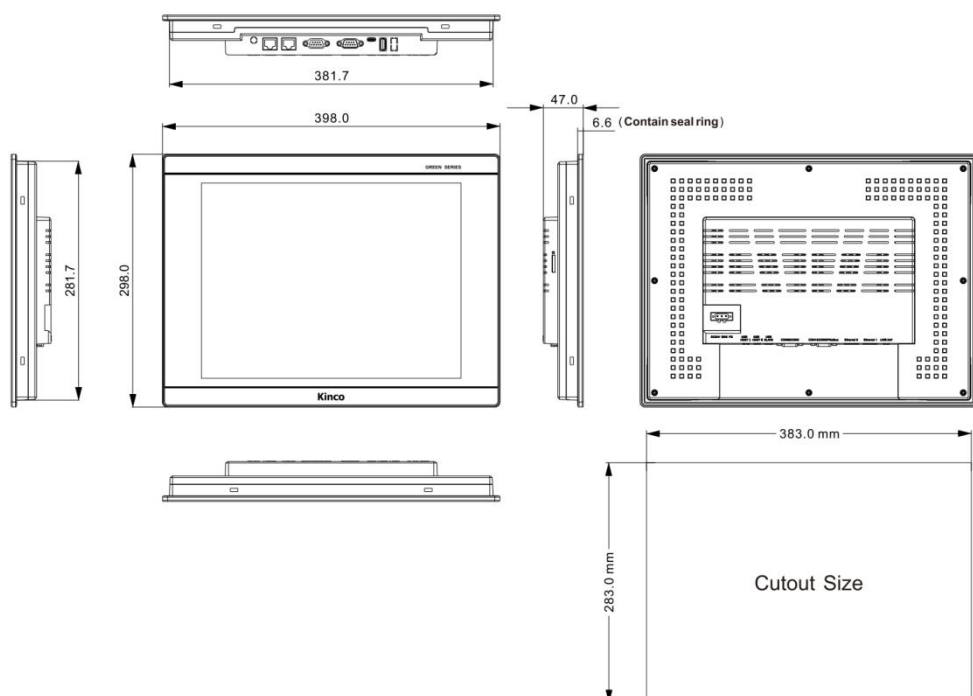

2.2 Fixed Screw Installation Instructions

The product is put into the well mounted hole of the machine control box's panel, and the mounting screws are inserted into the fixing holes around the HMI shell from the back of the control box's panel. Recommended lock torque: 0.5N.m (to waterproof effect and avoid shell deformation)

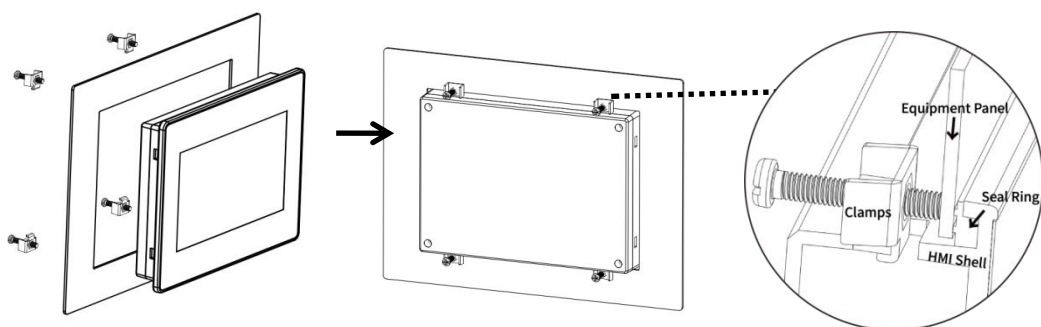

2.3 Power Connection

Before connecting the power, please make sure all local and national electrical standards are met. For power cables, please select cables with their dielectric strength values and current values in compliance with the safety specifications.

First find the power terminal at the back of the product and loosen the screw according to counterclockwise, then insert the power cables and tighten the screw up.

Connect positive DC line to the 'DC24V' terminal, the DC ground to the 'GND' terminal and the ground line to the 'FG' terminal.

3. External Interface

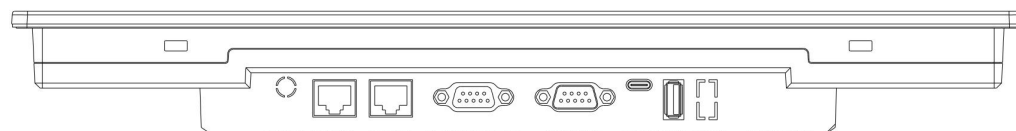

3.1 POWER

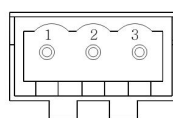

Pin#	Signal
1	DC24V
2	GND
3	FG

3.2 COM0/COM2

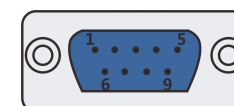

Pin assignment of the 9-pin male, D-SUB, COM0/COM2.
Note: RS232/485/422 communication functions are supported by COM0.COM2 supports RS232 communication function.

Pin	Signal	PLC (COM0) [RS-422]	PLC (COM0) [RS-485]	PLC (COM0) [RS-232]	PC/PLC (COM2) [RS-232]
1	Rx- (B)	RS422 R-	RS485 B		
2	RxD_PLC			RS232 RxD	
3	TxD_PLC			RS232 TxD	
4	Tx-	RS422 T-			
5	GND	Signal ground			
6	Rx+ (A)	RS422 R+	RS485 A		
7	RxD_PC				RS232 RxD
8	TxD_PC				RS232 TxD
9	Tx+	RS422 T+			

3.3 COM1

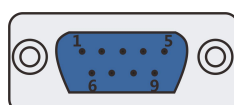

Pin assignment of the 9-pin male, D-SUB, COM1/CANbus.
Note: COM1 supports RS485 and RS422 communication function.

Pin	Signal	COM1 [RS-485]	COM1 [RS-422]
1	Rx- (B)	RS485 B	RS422 R-
4	Tx-		RS422 T-
5	GND	Signal ground	
6	Rx+ (A)	RS485 A	RS422 R+
9	Tx+		RS422 T+

3.4 USB HOST

Connection	Connect with USB interface devices or U disks
Port Function	This interface can be connected with USB keyboard, mouse and printers, and the U disk can be used for user's configuration uploading/ downloading as well as data storage.

3.5 USB SLAVE

The interface type is Type-c

Connection	USB Slave port can be connected with a PC
Port Function	The port is only used to download user configuration program to the HMI and to set HMI system parameters.

3.6 Ethernet0 /Ethernet1

10M/100M adaptive Ethernet RJ45 port.

Connection	With CAT5 UTP cable connected to the Ethernet device.
Port Function	The port can be used for upload/download of HMI configuration, setting of system parameters and online simulations of configurations. It can connect multiple HMIs via the Ethernet to form an HMI network. Furthermore, it can implement communications between HMI and PLC via the Ethernet, as well as communications with a PC via the Ethernet port.

4. After-sales Service

For < Service Terms and Conditions for HMI >, please check: <http://www.kinco.cn>

Importa y distribuye en Argentina:

ECFA

ECFA S.R.L.

Av. San Juan 4063 (C1233ABK) - Buenos Aires - Argentina

+54 11 4923-6566

ventas@ecfa.com.ar

<https://www.ecfa.com.ar>