

Kinco

User Manual

Kinco KC100 Series

Inverter



Shenzhen Kinco Electric Co., LTD

en.kinco.cn

Thank you for purchasing the KC100 inverter developed by Kinco Electric(Shenzhen) Ltd.

KC100 inverter is a general-purpose and easy-to-use high-performance vector inverter, which is mainly used to control and adjust the speed and torque of three-phase AC asynchronous motors, Can be used in textile, machine tools, packaging, food, fans, pumps and a variety of automated production equipment drive. This manual introduces detailed information on the product's assembly line, parameter settings, function applications, failure countermeasures, and maintenance.

Please be sure to read this user's manual carefully before use. Also, please use the product only after fully understanding its safety precautions.

Important Notes

After opening the box, please make sure that the product packaging is not damaged during transportation.

To illustrate specific details of the product, some diagrams in this manual may depict the product with the casing or safety covers removed. When using this product, it is essential to ensure that the casing or covers are properly installed as specified and follow the instructions in the manual.

The diagrams in this manual are for explanatory purposes only and may differ from the product you have ordered.

Our company is committed to the continuous improvement of our products, and product features may undergo upgrades without prior notice. Any changes to the provided information will not be separately communicated.

If you encounter any issues with any of the above aspects, please contact our company or your supplier for resolution.

Version Change Record

Version	Chapter	Update Date	Update Content	Supported Software versions (D02.04)
1.0	Full Version	2023-08	First Edition Release	Uninvolved
1.1	2.7.3	2023-12	Linear guide purchase instruction.	Uninvolved
	7.7		VF control parameters add energy saving control, involving parameters F05.30~F05.33.	V1.08 and above
	7.16		Communication Parameters add Master/Slave communication control, involving parameters F14.10 to F14.12.	V1.08 and above
	7.22.1		Add D00.55: Current fault.	V1.08 and above
	7.22.2		Add three groups of fault parameters: D01.36 to D01.71.	V1.08 and above
1.2	7.4	2024-1	Add frequency instruction resolution ratio, involving parameters F01.15.	V1.10 and above
	7.15		Add 440V voltage level	V1.10 and above
	7.20		Add the function of AI as DI	V1.12 and above
	7.21		Add F19: Communication mapping parameter group	V1.10 and above
	2.7.4		Add the installation and purchase instructions of the ground lug	Uninvolved

	3.2.2		Add recommended specifications for fuses, contactors and circuit breakers	Uninvolved
	9		Add Chapter 9 "Accessory recommendation"	Uninvolved
	10		Add Chapter 10 "Compliance with certification Standards"	Uninvolved
1.3	5.8.4	2024-7	Add PID sleep function and PID preset frequency function; involving parameters: F16.31 to F16.36;	V1.14 and above
	5.2.9 5.9.4		Add simple PLC function, involving parameters: F17.17 to F17.34;	V1.14 and above
2.0	Chapter 2 Chapter 3	2024-8	Shell and terminal modification, multi-function input terminal adjustment	V1.14 and above
2.1	Chapter 2 Chapter 3 Chapter 6 Chapter 9	2024-9	Add L model; Add the order number of the external keyboard (with the installation box); Add E0008 fault code	V1.14 and above
2.2	2.5	2024-10	Update dimension information	V1.14 and above
	2.6.3 9.4		New accessory information	
2.3	5.11.1	2025-1	Correcting function code	V1.16 and above
	7.10		Delete F08.12 function code	
2.4	9.4	2025-3	Correct accessory table content	V1.16 and above
2.5	7.19	2025-4	Add parameters F17.51-F17.57	V1.16 and above
	7.21		Modify parameter description	
2.6	7.15	2025-5	Modify the parameters F13.40 and F13.42	V1.16 and above
2.7	6.2	2025-8	Modify the content of the E0023 fault code	V1.16 and above
2.8	5.12	2025-9	Add Content	V1.16 and above
	7.4,7.7,7.16		Update function code	
	Appendix I		Update the address description of communication control parameter group	
2.9	5.9.5	2025-10	Add fire mode relevant content ,	V1.19 and above
	7.15,7.22 , 7.23,7.24		Add parameters F13.70~F13.72, D00.63	

2.10	7.10,7.12	2026-01	Update parameter description	V1.19 and above
2.11	2.2,2.3,7.4	2026-3	Update the maximum frequency range value	V1.21and above
	5.9,5		Add fire mode shutdown detection instruction	
2.12	Chapter 9	2026-4	Update the order number of the optional accessories	V1.21and above

Catalogue

Preface	1
Important Notes	1
Version Change Record	1
1 Security Information	8
1.1 Security Definition	8
1.2 Security Claims	8
2 Product Information	10
2.1 Product Confirmation	10
2.2 Nameplate and Model Number	10
2.3 Technical Specifications	10
2.4 Product Parts	13
2.5 Mounting Dimensions	14
2.6 Installation Of The KC100 Inverter	16
2.6.1 Environment Requirements	16
2.6.2 Mounting Space	16
2.6.3 Mounting Method	19
2.6.4 Ground lug mounting	20
3 System Interface And Wiring	21
3.1 Peripheral System Configuration	21
3.2 Electrical Wiring Diagram	22
3.2.1 Main Circuit Terminal Configuration Connection Instructions	23
3.2.2 Recommended Fuses, Contactors, And Circuit breakers	24
3.2.3 CN2 Control circuit terminal configuration connection instructions	25
3.2.2.1 Use Of Harness Grooves	26
3.2.2.2 Analog Output Wiring	26
3.2.2.3 Wiring Method Of Analogue Input	27
3.2.2.4 Wiring Method For Multifunctional Digital Inputs	28
3.2.2.5 Wiring Method For High Speed Pulse Output	31
3.2.2.6 Relay Output Wiring	32
3.2.4 Dip Switch Function Legend And Description	32
4 Keyboard Layout And Operating Instructions	33
4.1 Keyboard Layout	33
4.1.1 Built-in Keyboard	33
4.1.1.1 Status Indicator	34
4.1.1.2 Data Display	34
4.1.2 External Keyboard	35
4.2 Menu Description	36
4.3 Status Parameter Display	36
4.4 Parameter Setting	38
4.5 M Multifunction Key Operation	38
4.6 The Operation Panel Drives The Motor	39

5 Function Introduction	41
5.1 Operation Command Setting	41
5.1.1 Run command channel setting	41
5.1.2 Operating Panel Control	41
5.1.3 Terminal I/O Control	41
5.1.4 Communication Control	43
5.2 Frequency Reference Sources	44
5.2.1 Setting Frequency Reference Sources	44
5.2.2 Selecting Source of Main Frequency Reference	44
5.2.3 Setting Main Frequency Through Operating Panel	45
5.2.4 Setting Main Frequency Through Analog Input	46
5.2.5 Setting Main Frequency Through Communication	48
5.2.6 Setting Main Frequency Through Pulse Input	49
5.2.7 Setting Main Frequency Through PID	50
5.2.8 Setting Main Frequency Through Multi-reference	52
5.2.9 Setting the main frequency through simple PLC	52
5.2.10 Selecting Source of Auxiliary Frequency Reference	53
5.2.11 Setting Frequency Based on Main and Auxiliary Frequency References	53
5.2.12 Main Frequency Source Bound To The Command Source	55
5.2.13 Setting Action to Take When Frequency Is Below Lower Limit	56
5.2.14 Setting Frequency Reference Limits	56
5.2.15 Skip Frequency	56
5.3 Jogging	58
5.4 Start-stop Instruction	59
5.4.1 Startup Modes	59
5.4.1.1 Direct Start	59
5.4.1.2 Pre-Excitation Start	60
5.4.1.3 Speed tracking start	60
5.4.2 Stop Modes	60
5.4.2.1 Decelerate To Stop	60
5.4.3 Acceleration and Deceleration Time Setting	62
5.5 Control Terminals	64
5.5.1 DI	64
5.5.2 AI	64
5.5.3 DO	64
5.5.4 AO	64
5.6 Motor Configuration	65
5.6.1 Motor Control Mode Selection	65
5.6.2 Motor Parameter Self-learning	65
5.7 Control Performance	67
5.7.1 Speed Loop and Torque Limit	67
5.7.1.1 Speed Loop	67
5.7.1.2 Speed Control Torque Upper Limit	68
5.7.1.3 Vector Control Slip Gain	69
5.7.2 Current Loop	69
5.7.3 Over-current Control	69
5.7.4 Over-voltage Control	70
5.7.5 Under Voltage Control (Instant Stop Without Stopping)	71
5.8 Introduction to Application Functions	73
5.8.1 Frequency Detection	73
5.8.1.1 Frequency Detection (FDT)	73

5.8.1.2 Frequency Reaches Detection Amplitude	74
5.8.1.3 Any Arrival Frequency Detection Value	75
5.8.2 Current Detection	76
5.8.2.1 Zero-current Detection	76
5.8.2.2 Output Current Exceeding Limit Detection	76
5.8.2.3 Arbitrary Arrival Current Detection	77
5.8.3 Forward and Reverse Instructions	77
5.8.3.1 Dead-band Time for Forward and Backward Rotation	77
5.8.3.2 Reverse Frequency Prohibition and Rotation Direction Selection	78
5.8.4 PID preset frequency and PID sleep	79
5.8.4.1 PID preset frequency switching	79
5.8.4.2 PID sleep	80
5.9 Introduction of Auxiliary Functions	81
5.9.1 Hibernation and Wakeup	81
5.9.2 Timing Function	81
5.9.3 Counting Function	82
5.9.4 Counting Function	83
5.9.5 Fire mode function	85
5.10 User Password	86
5.11 Parameter Initialization and Upload-download	86
5.11.1 Initialize (Restore Default Settings)	86
5.11.2 Upload and Download	87
5.12 Terminal and AC drive status bit description	87
5.12.1 AC drive status	87
5.12.2 DI status	88
5.12.3 DO status	88
5.13 Fault and Protection	89
5.13.1 Startup Protection	89
5.13.2 Undervoltage/Overvoltage Threshold	89
5.13.3 Phase Loss Protection	89
5.13.4 Fault Resetting	90
5.13.5 Fault Action Protection Selection	91
6 Fault Handling	92
6.1 Common Faults and Diagnosis	92
6.1.1 Alarm and Fault Display	92
6.1.2 Restart Upon Faults	92
6.1.3 Common Troubleshooting	93
6.1.4 Different Control Mode Under Trial Operation Treatment Countermeasures	94
6.1.4.1	94
6.1.4.2 Open-loop Vector Control Mode	95
6.2 List of Fault Codes	95
7 Quick List Of Function Parameters	100
7.1 Parameter Terminology Description	100
7.2 Parameters List	100
7.3 Group F00: Environmental Applications	100
7.4 Group F01: Basic Parameters Group	101
7.5 Group F02: Start/Stop Control Parameters	104
7.6 Group F03: Motor Parameters	106



7.7 Group F05: V/f Control Parameters 107

7.8 Group F06: Speed Loop and Torque Control Parameters 109

7.9 Group F07: Current Loop and Flux Control Parameters 110

7.10 Group F08: Terminal DI Function Parameters 110

7.11 Group F09: Terminal AI Function Parameters 112

7.12 Group F10: Terminal DO Function Parameters 113

7.13 Group F11: AO Terminal Function Parameters 115

7.14 Group F12: Auxiliary Function Parameters 116

7.15 Group F13: Protection Parameters 117

7.16 Group F14: Communication Parameters 121

7.17 Group F15: Display Parameters 122

7.18 Group F16: PID Parameters 124

7.19 Group F17: Multi-reference Parameters 125

7.20 Group F18: Extended terminal parameters 128

7.21 Group F19 : Communication Mapping Parameters 128

7.22 Group D0x: Monitor Parameters 129

 7.22.1 Group D00: Condition Monitoring Parameters 129

 7.22.2 Group D01: Fault Monitor Parameters 130

 7.22.3 Group D02: System Information 131

7.23 Fault Code Table 132

8 Inspection, Maintenance and Assurance 133

8.1 Inspection 133

8.2 Maintenance 134

8.3 Product Warranty 134

9 Accessory Recommendation 135

9.1 Braking Resistors 135

9.2 EMC Filter 135

 9.2.1 External filters are available for single-phase models 135

 9.2.2 External filters are available for three-phase models 135

 9.2.3 Installation requirement 136

9.3 Common EMC problems and solutions 136

 9.3.1 Ground cables and grounding issues 136

 9.3.2 ESD discharge issues 136

 9.3.3 Transient interference 136

 9.3.4 Harness interference 136

 9.3.5 Power supply fluctuation and inrush current 137

 9.3.6 Leakage protection circuit breaker works incorrectly 137

 9.3.7 Control loop interference 137

 9.3.8 Communication interference 138

9.4 Other Optional Accessories 138

10 Compliance with certification standards 139

10.1 CE Certification 139

10.2 Meet the requirements of the EMC directive 139

Appendix 1: Modbus Communication Protocol 140

1 Security Information

To ensure the safe and proper use of this product, please read and fully understand the safety information described in this manual before using it. Our company shall not bear any legal responsibility for personal injury or equipment damage resulting from non-compliance with the instructions in this manual.

1.1 Security Definition

The following markings are used in this manual to indicate that this area is important for safety. If these precautions are not followed, it may result in personal injury or death, as well as damage to this product and associated systems.



Danger The information marked as dangerous is crucial for avoiding safety accidents.



Warnings The information marked as a warning is necessary to avoid damaging the product or other equipment.

Note

Note The information marked as Note is helpful in ensuring proper operation of the product.

1.2 Security Claims

Operating qualifications

This product must be operated by trained professionals. In addition, the operator must go through professional skills training, familiar with the installation, wiring, operation and maintenance of the equipment, and correctly respond to various emergency situations in use.

Unpacking and Acceptance

Note

Attention!

- Before unpacking, first check whether the appearance of the package is normal and intact, without obvious scratches, extrusion deformation, damage, or be affected with damp. For safety reasons, do not use products with damaged packaging or parts.
- Please verify that the model number and quantity match the order information as per the order list inside the box and the nameplate information on the product.
- Please confirm whether all terminal accessories are complete and there are no defects or rust on the surface of the product.

Storage and Transportation



Warnings!

During transportation, do not let the operating panel and cover plate be under pressure, otherwise there is a risk of personal injury or damage to property when the product falls. AC drive stored for more than 2 years should be gradually boosted with a voltage regulator when powered on, otherwise there is a risk of electric shock and explosion.

Please store the product according to the specified requirements. The storage environment should be dry, free from corrosive gases, non-conductive dust, and direct sunlight. The temperature should be maintained below 60°C. During transportation and storage, precautions should be taken to avoid impacts and vibrations on the AC drive, as there is a risk of product damage.

Installation requirements



Warnings!

- Install in a place that can withstand the weight of the AC drive, otherwise there is a risk of injury or damage to property when dropped.
- Please ensure that the installation is secure and the screws are tightened to prevent the product from falling and damaging during use.
- Before powering on the product, it must be installed in the electrical cabinet and ensure that all protective measures have been activated.
- During operation, it is strictly forbidden to touch the heat sink, fan, braking resistor, and other components of the product to check the temperature, as there is a risk of burns.
- This product must be installed inside an electrical enclosure when in use, and all protective measures must be activated.
- In applications with severe dust, metal debris, and oil pollution, equipment electrical cabinets with good sealing should be used.
- Due to the pulse waveform of the output voltage of the AC drive, if there are capacitors or lightning protection varistors installed on the output side to improve power factor, please be sure to remove or modify them on the input side of the AC drive.
- Please refer to Chapter 2 for instructions on installing equipment and retaining sufficient heat dissipation space. If the ambient temperature inside the cabinet exceeds the allowable range, it is necessary to consider derating for use.
- Static electricity in the human body can seriously damage internal sensitive devices. Before carrying out relevant operations, please follow the measures and methods specified in the Static Electricity Prevention Measures (ESD), otherwise the frequency converter may be damaged.

Danger!



- Please install on metal or other flame-retardant objects. Flammable objects are prohibited from touching/attaching to the product, otherwise there is a danger of fire..
- Do not install or use the product in environments with corrosive substances such as hydrogen sulfide, sulfur dioxide, chlorine gas, ammonia, sulfur, corrosive gases, acids, alkalis, salts, or in proximity to flammable gas environments and combustible materials, as it may pose a risk of fire.
- If there is any damage to the product surface or if any components are missing, please do not install or operate it, as it may pose a risk of fire or injury.
- Foreign objects such as screws, metal spacers, and metal rods that fall inside the inverter pose a risk of fire and damage to property.
- Wiring operations must be carried out by a professionally qualified person, otherwise there is a risk of electric shock.
- Make sure that the input power is completely disconnected before wiring, otherwise there is a risk of electric shock.
- The grounding terminal of the inverter must be reliably grounded, with a grounding resistance less than 10Ω , otherwise there is a risk of electric shock.
- The RB+ and RB- terminals are used to connect the braking resistor, and must not be shorted, otherwise the product may be damaged or cause a fire.
- Please do not add circuit breakers or contactors and other switching devices on the output side of the inverter, if there are special working condition requirements, please contact the manufacturer for further communication.
- This product controls a potentially hazardous motion mechanism. Failure to comply with the regulations or to operate in accordance with this manual may result in personal injury or death and damage to the product and related systems.
- Please make sure that the power supply meets the requirements of the product before powering up, otherwise the product may be damaged or cause fire.
- Before powering up, please make sure that the terminals are connected reliably, the cables are connected tightly, and the protective cover must be put on, otherwise there is a risk of electric shock and explosion.
- Do not touch the product and terminals under power-on conditions, and do not disassemble the parts of the product, otherwise there is a risk of electric shock.
- Maintenance operations should be carried out after disconnecting the power supply for 10 minutes, at which time the charging indicator light is completely off or it is confirmed that the positive and negative bus voltages are below 36V, otherwise there is a risk of electric shock.
- Parts must be replaced only by a professional. It is strictly forbidden to leave wires or metal objects inside the machine, otherwise there is a risk of fire.
- After replacing the control board, the parameters must be set correctly before operation, otherwise there is a risk of damage to property.

2 Product Information

2.1 Product Confirmation

When you received the inverter, please check the following items.

- Make sure the package and the unit is in the status as undamaged. And which is same as what you ordered.
- The thing which damaged by transportation isn't on the scope of guarantees, please contact with us by the service line to provide related assistance.

2.2 Nameplate and Model Number

Nameplate:

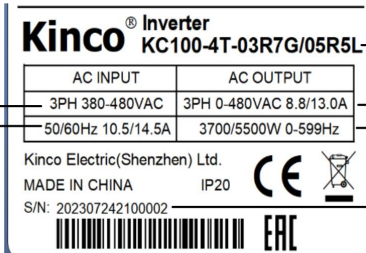

Kinco® Inverter KC100-4T-03R7G/05R5L — Product model

AC INPUT	AC OUTPUT
3PH 380-480VAC	3PH 0-480VAC 8.8/13.0A
50/60Hz 10.5/14.5A	3700/5500W 0-599Hz

Input phase, input voltage — 3PH 380-480VAC
 Output phase, Output voltage, Rated current — 3PH 0-480VAC 8.8/13.0A
 Input frequency, Rated current — 50/60Hz 10.5/14.5A
 Output power, Rated frequency — 3700/5500W 0-599Hz

Kinco Electric(Shenzhen) Ltd.
 MADE IN CHINA IP20
 S/N: 202307242100002 — Product serial number

CE, EAC, and other safety symbols are also present.

designation rule:

KC100 - 4 T - 03R7G /05R5 L

KC100	KC100 Series			0R40	0.4kW (R stands for decimal point)
2	Input AC220V			0R75	0.75kW
4	Input AC380V		
5	Input AC440V			05R5	5.5kW
T	Phase class: 3 Phase			G	Heavy load
S	Phase class: 1 Phase			L	Light load

2.3 Technical Specifications

Table 2-1 Specification of KC100-2S series (1phase AC220V)

Item		Specification			
Type: KC100-2S		0R40G/0R75L	0R75G/01R5L	01R5G/02R2L	02R2G/03R7L
Input	Rated input current (A)	5.3/8.2	8.2/14.0	14.0/23.0	23.0/32.0
	Rated voltage	1phase 200V ~ 240V			
	Rated frequency	50Hz/60Hz			
	Fluctuation range	Voltage: -15% ~ +10%, voltage imbalance rate: <3%, frequency: ±5%			
Output	Power supply capacity (kVA)	1.0/1.5	1.5/3.0	3.0/4.0	4.0/6.4
	Power(kW)	0.4/0.75	0.75/1.5	1.5/2.2	2.2/3.7
	Output current (A)	2.5/4.0	4.0/7.5	7.5/10.0	10.0/16.0
	Output Voltage	Output of Rated condition: 3phase, 0 ~ Input voltage			
	Range of output frequency	0 ~ 599Hz			
Overload capacity	60s at 150% the rated current, 3s at 180% rated current				
Cooling method	Forced air cooling				

Table 2-2 Specification of KC100-4T/5T series (3phase AC380V and AC440V)

Item		Specification				
Type:	KC100-4T/5T	0R75G/01R5L	01R5G/02R2L	02R2G/03R7L	03R7G/05R5L	05R5G/07R5L
Input	Rated input	3.4/5.0	5.0/5.8	5.8/10.5	10.5/14.5	14.5/20.5
	Rated voltage	three-phase 380V~480V				
	Rated frequency	50Hz/60Hz				
	Fluctuation range	Voltage: -15% ~ +10%, voltage imbalance rate: <3%, frequency: ±5%				
	Power supply capacity	1.5/3.0	3.0/4.0	4.0/5.9	5.9/8.5	8.5/11.0
Output	Power(kW)	0.75/1.5	1.5/2.2	2.2/3.7	3.7/5.5	5.5/7.5
	Output current (A)	2.3/3.7	3.7/5.5	5.5/8.8	8.8/13.0	13.0/17.0
	Output Voltage	Output of Rated condition: 3phase, 0~Input voltage				
	Range of output	0~599Hz				
	Overload capacity	60s at 150% the rated current, 3s at 180% rated current				
Cooling method	Forced air cooling					

Table 2-3 Inverter technical specifications

Main control performance	Motor class	Three-phase AC asynchronous motor
	Motor control mode	V/F control, Sensorless vector control (SVC), V/F voltage frequency separation control
	Modulation mode	Space Vector Pulse Width Modulation
	Carrier frequency	0.5kHz to 12.0kHz
	Speed range	Open - loop vector control: rated load 1:200
	Frequency control accuracy	Open loop vector control: ±0.5% rated synchronous speed;
	Startup torque	Open - loop vector control: 150% rated torque at 0.5Hz
	Torque response	Open - loop vector control: < 20ms
	Frequency setting accuracy	Digit setting: maximum frequency x (±0.01%); Analog setting: Max frequency x (±0.2%)
	Frequency setting resolution	Digital setting: 0.01Hz; Analog setting: maximum frequency x 0.1%
	Torque boost	Automatic boost:0.0%; manual boost: 0.1 % to 30.0 %
Product basic functions	Dc braking ability	Starting frequency: 0.00Hz ~ 50.00Hz Braking time: 0.0s ~ 60.0s Braking current level: 0.0% ~ 150.0% rated current
	V/F curve	Four Methods: multi-point V/f curve;Reduced torque characteristic curve; half V/f separation;complete V/f separation;
	Acceleration/ deceleration curve	Straight-line or S-curve acceleration/deceleration;Four groups of acceleration/deceleration time
	multi-speed running	The product supports up to 8 speeds with the control terminal

	Built-in PID	The function facilitates closed-loop control of process control.
	Auto voltage regulation (AVR)	When the mains voltage changes, the output voltage keeps constant automatically.
	Overvoltage/overcurrent stall control	The function limits the current and voltage automatically during operation to prevent frequent trips caused by overvoltage or overcurrent.
	Fast current limit	The function helps minimize overcurrent faults.
	Power dip ride-through	Load regenerative energy compensates for voltage reduction during instantaneous power failure, allowing the AC drive to continue operating for a short time.
	Running command	Running commands can be given through the operating panel, control terminal, or serial port communication, which can be switched over in various ways.
	Frequency reference	digital settings, analog voltage, analog current, pulse, or serial port communication.
	Auxiliary frequency reference	It can implement fine tuning of the auxiliary frequency and frequency synthesis.
	Input terminals	4 digital input terminals, 1 of which supports high-speed pulse input up to 50KHz
		1 analog input terminal, support 0 ~ 10V/0 ~ 20mA input
	Output terminals	1 relay output terminal, including normally closed and normally open sub
		1 analog output terminal, support 0 ~ 10V voltage output
1 digital output terminal, 0.1kHz~50kHz pulse square wave signal output, capable of outputting physical quantities such as set frequency and output frequency		
1 way 485 communication terminal		
Network Port	External keyboard interface	
Keyboard Display	LED display	Single row 5-digit digital tube, with the same built-in keyboard and external keyboard
	Parameter copy	Quick parameter copy through the external keyboard
	Condition monitoring	Can display set frequency, output frequency, output voltage, output current and other parameters
	Fault Alarm	Overvoltage, undervoltage, overcurrent, short circuit, phase loss, overload, overheating, etc
Environment	Altitude	In areas with an altitude exceeding 1000m, due to the poor heat dissipation effect of the frequency converter due to the thin air, it needs to be derated for use, with a 1% derating for every 100m increase
	Temperature	-10°C ~ +50°C
	Humidity	5%RH to 95%RH (no condensation)
	Vibration	Less than 5.9m /s ² (0.6g)
	Storage temperature	-20°C ~ +60°C
	Overvoltage class	OVCIII
	Pollution levels	PD2
	Level of protection	IP20
Installation method	Wall-mounted, Guide rail mounted	

2.4 Product Parts

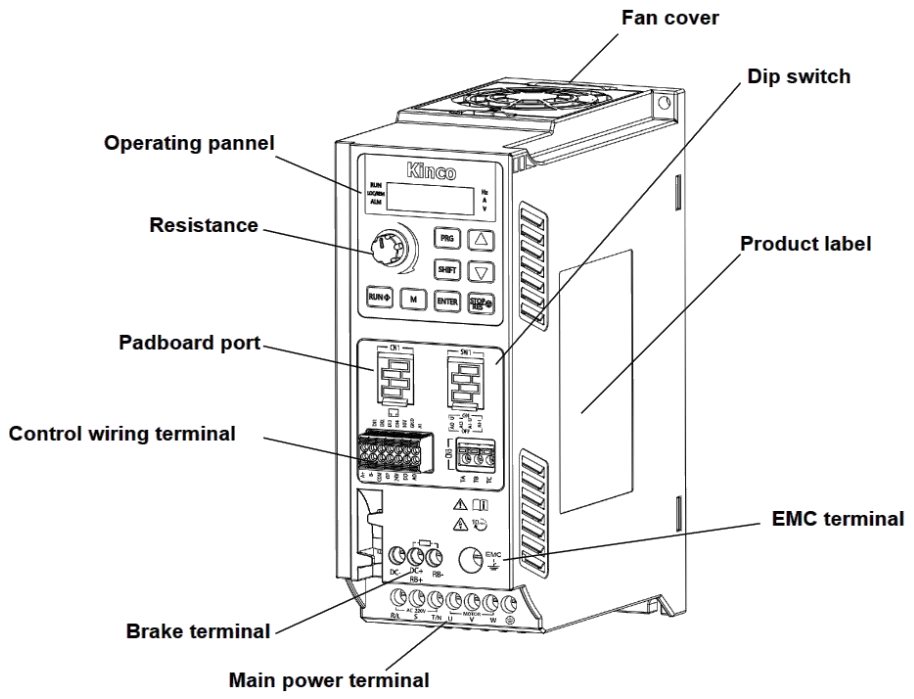

Figure 2-1 Schematic diagram of the product parts

Note

Attention!

- Different power segment products have different sizes, but the terminal layout is the same.

2.5 Mounting Dimensions

Please follow the requirement to install your equipment and ensure the product must only be placed in operation by a qualified electrician who are familiar with the requirement both for EMC and safety.

Table 2-4 Dimensions

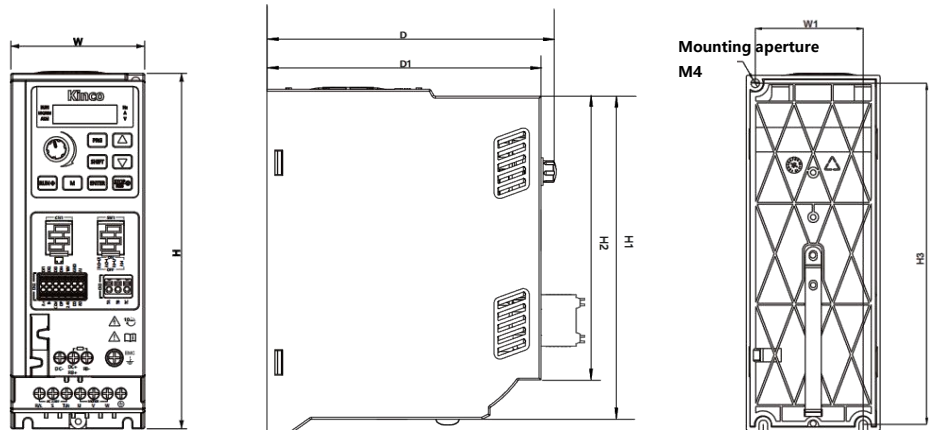

Fixing screws: 3×M4
Recommended tightening torque:1.2N.M

Model type	Dimension (mm)						Dimension (mm)			Hole diameter of installation (mm)	Weight (kg)
	W	H	H1	H2	D	D1	W1	W2	H3		
KC100-2S-0R40G/0R75L	65	177	168.5	145	150	140	50	45	168	3-M4	0.85
KC100-2S-0R75G/01R5L											
KC100-4T/5T-0R75G/01R5L											
KC100-4T/5T-01R5G/02R2L											
KC100-2S-01R5G/02R2L	75	199	190	166	167	156	60.5	56	191	3-M4	1.20
KC100-2S-02R2G/03R7L											
KC100-4T/5T-02R2G/03R7L											
KC100-4T/5T-03R7G/05R5L											
KC100-4T/5T-05R5G/07R5L											1.28

Table2-5 Dimensions of external keyboard and mounting box

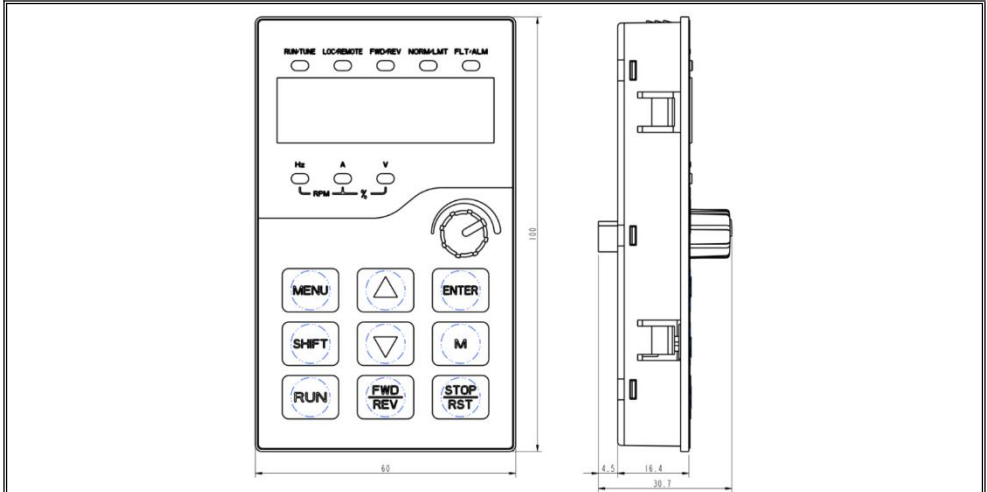

Figure 2-2 Dimension of External operating panel

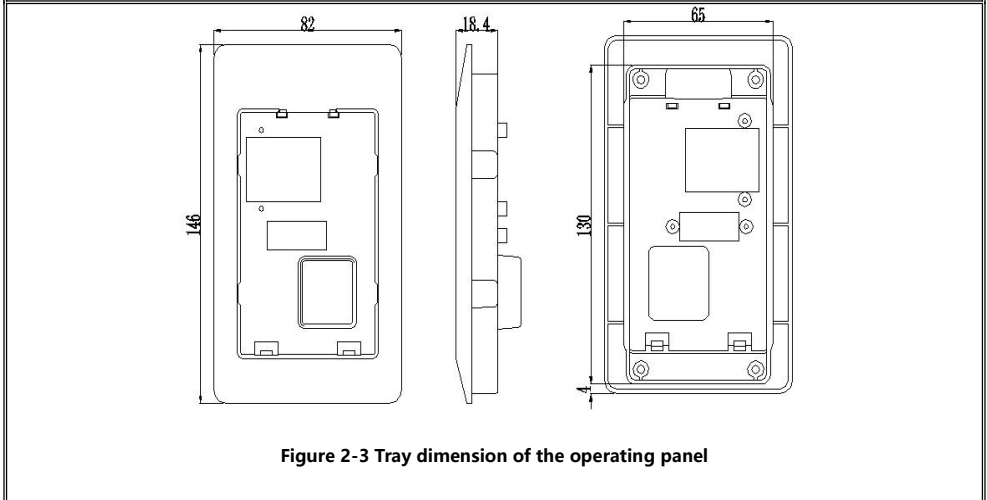

Figure 2-3 Tray dimension of the operating panel

Note

Attention!

- The hole size of the operating panel is 65*130mm if you select the outside lead mounting
- Select external keyboard ,see chapter 9.4!

2.6 Installation Of The KC100 Inverter

2.6.1 Environment Requirements

Table 2-6 Environment requirements

Environment	Requirement
Working temperature	-10°C ~ +50°C
Working humidity	5%RH ~ 95%RH (no condensation)
Storage temperature	-25°C ~ +70°C
Degree of protection	IP20
Mounting conditions	Wall-mounted
Assembly requirement	Indoors and well-ventilated Without sunlight, corrosive gas, flammable gas, and no dust.
Altitude	Less than 2000m Required 1% power derating per 100m from 1000m to 2000m.
Vibration	Less than 5.9m/s ² (0.6g)

It is required 1% derating per 100m if the altitude is more than 1000m. Following is the derating curve.

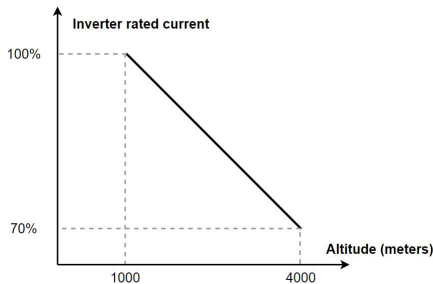

Figure 2-4 Derating curve

2.6.2 Mounting Space

Attention!

- The inverter has to be installed in a electrical cabinet which provides a pollution degree 2 environment.
- The installation orientation is vertical to provide sufficient convection air flow through the inverter housing.
- Comply with distances and clearances shown in figure 2-5.
- Ensure that the inverter is securely mounted with two M4 screws.
- It is needed to install a qualified plate to ensure the direction of ventilation as good as the rule due to the direction of ventilation is from the bottom to the top.
- Do not insert anything into the ventilation openings of the inverter.
- Do not block the ventilation openings of the inverter.

Note

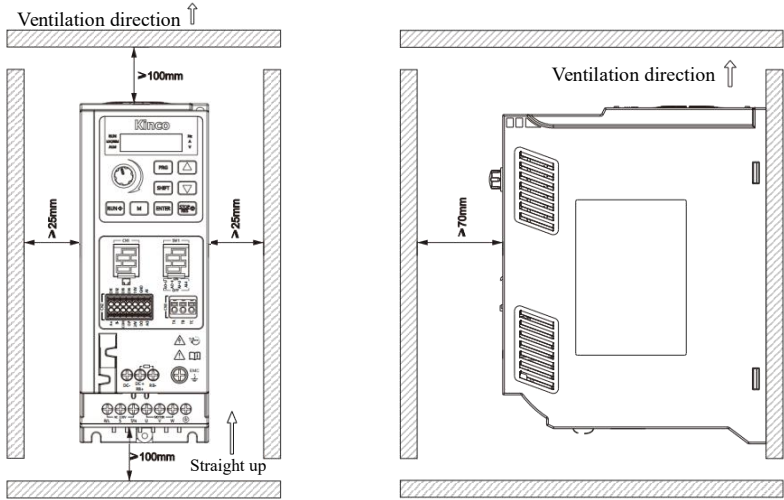

Figure 2-5 Mounting direction

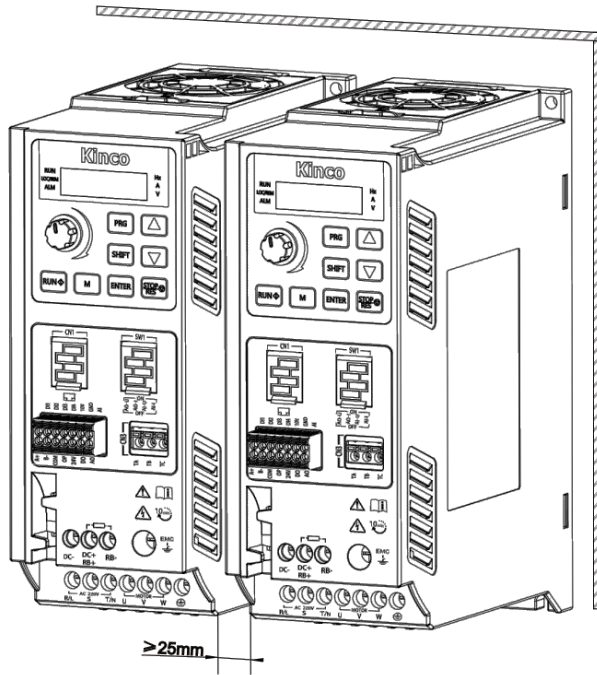

Figure 2-6 Mounting by Horizontal as side by side

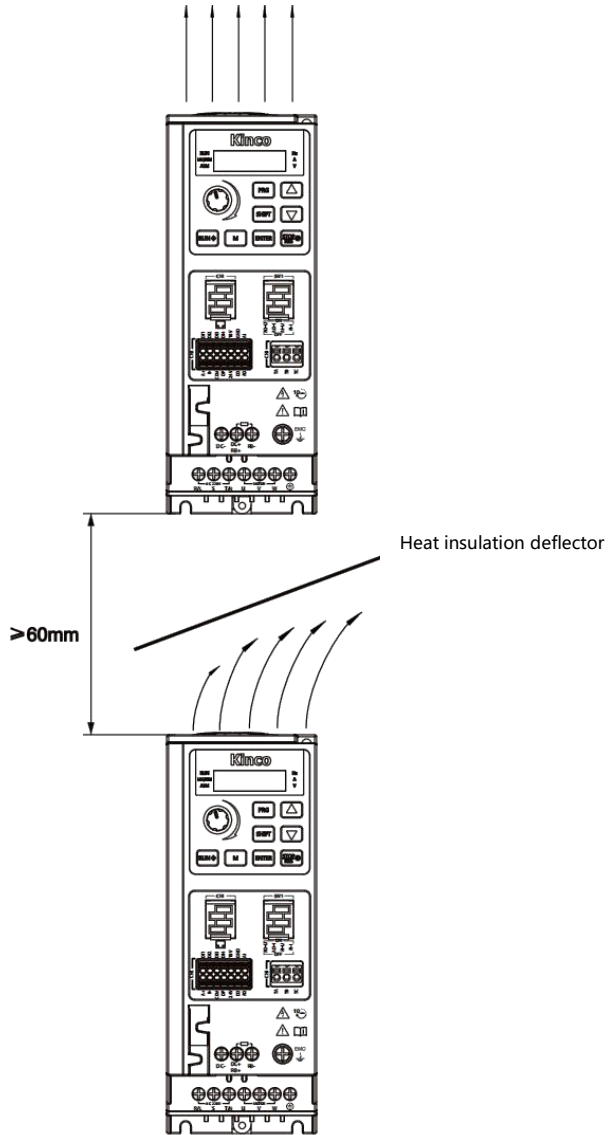

Figure 2-7 Mounting by vertical as side by side

2.6.3 Mounting Method

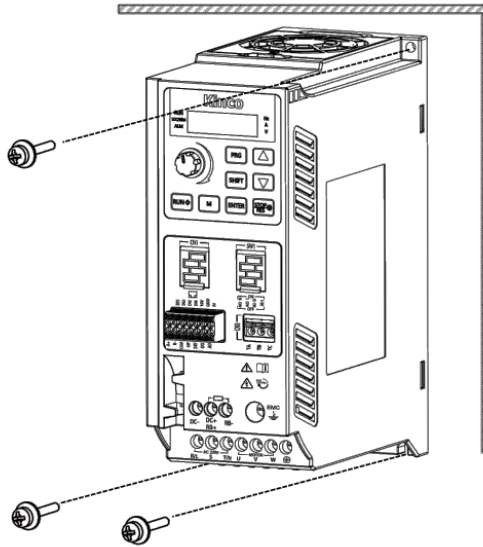

Figure 2-8 Front view of Mounting Drawing

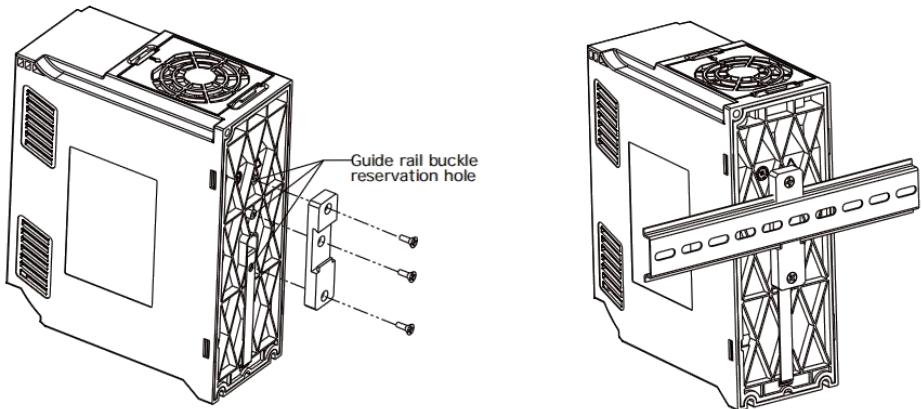

Figure 2-9 Back view of mounting drawing

Note

Attention!

Select guide rail buckle and guide rail buckle fixing screw, see chapter 9.4!

2.6.4 Ground lug mounting

In order to meet the requirements of EN IEC 61800-3 standard radiation and conductive emission, a ground lug must be installed. The ground lug is fixed with M4 screws .

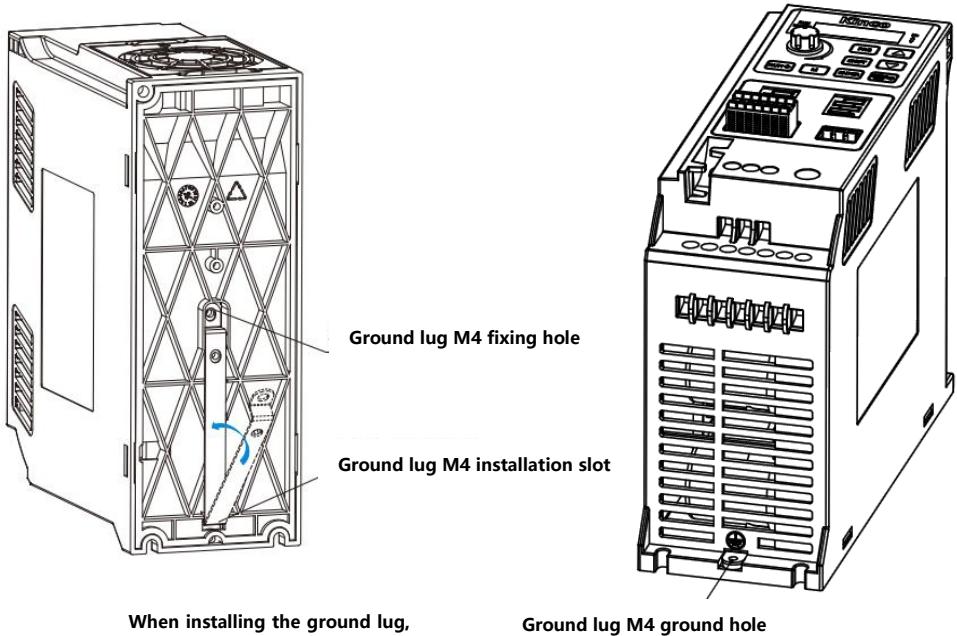

When installing the ground lug, insert it into the mounting slot and secure it using M4 screws

Ground lug M4 ground hole

Figure 2-10 Grounding lug installation diagram

Note

Attention!

Select ground lug ,see chapter 9.4!

3 System Interface And Wiring

3.1 Peripheral System Configuration

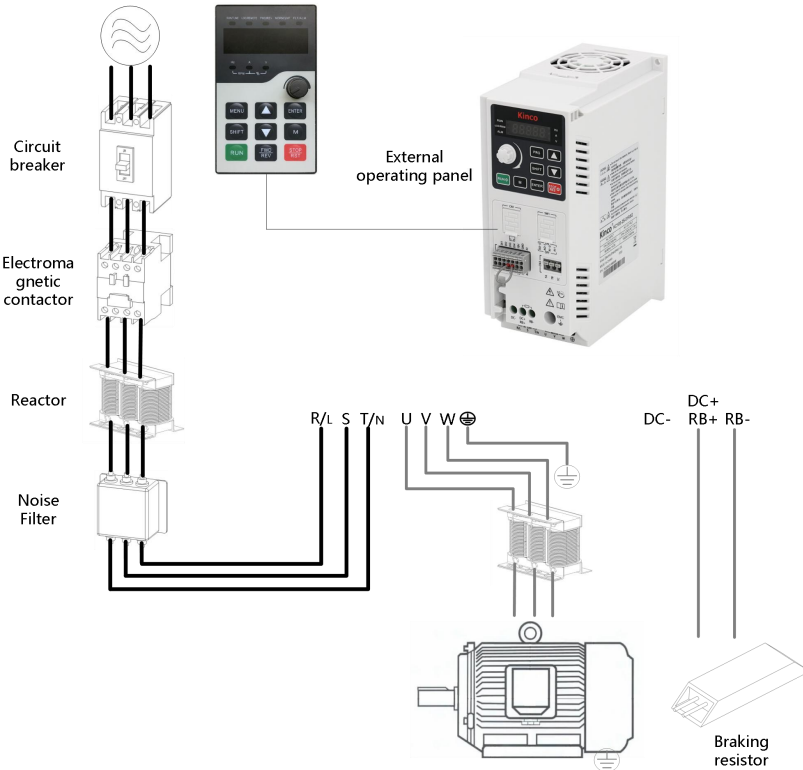

Figure 3-1 System peripheral configuration diagram

Table 3-1 Electrical configuration of the peripherals

Name	Instructions
Circuit Breaker	The capacity of the circuit breaker is generally selected by 1.5 ~ 2 times the rated current of the inverter.
Electromagnetic contactor	Easy to control, but frequent opening and closing of the contactor will cause the failure of the inverter.
Input reactor	Improve the influence of power factor and three-phase unbalance on the system; Suppress the influence of peak current on the input of inverter; Weaken the external interference.
Input filter	Improve the anti-interference ability of frequency converter, weaken the external interference of frequency converter.
Output reactor	The AC reactor installed between the inverter and the motor cable can effectively suppress the harmonic voltage and reduce the leakage current.
Braking resistor	Consume the energy returned by the motor to achieve fast braking.

3.2 Electrical Wiring Diagram

The power wiring diagrams of the three-phase and single-phase models are displayed in dotted lines.

Connect cables according to the actual models

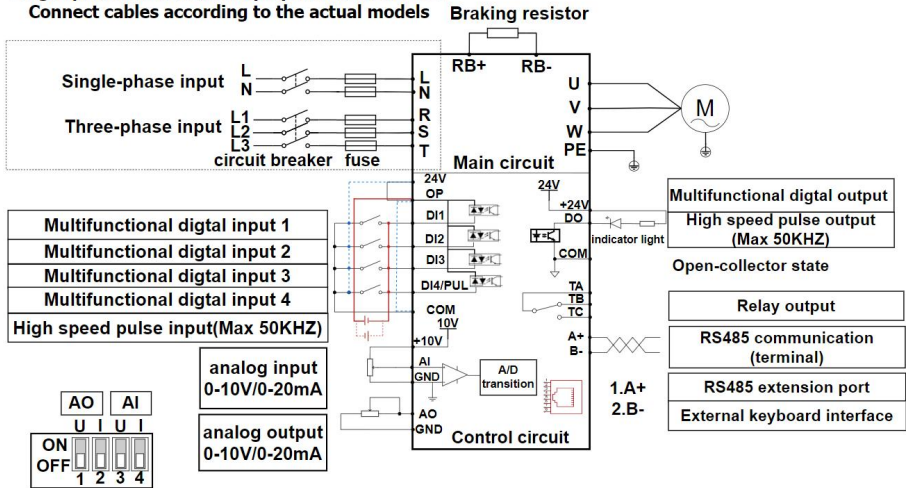

Note:
 1. DI1-DI4 can support NPN and PNP transistor signal input, bias voltage can be connected to the inverter internal power supply (+24V terminal) or external power supply (OP terminal)
 2. In the figure, black solid lines and blue dashed lines indicate two connection methods of DI1-DI4 connect to the internal power supply. red solid lines and red dashed lines indicate two connection methods of DI1-DI4 connect to the external power supply

Figure 3-2 Basic wiring connection diagram of the frequency converter

Danger!

- Before powering on, please confirm whether the input power of the inverter meets the product requirements, otherwise it may cause product damage or cause fire.
- Before powering on the converter, ensure that terminals are connected reliably and cables are securely connected. Cover the protective cover properly; otherwise, electric shock and explosion may occur.
- The maintenance operation should be carried out 10 minutes after the power is disconnected, at which time the charging indicator is completely turned off or the positive and negative bus voltage is below 36V, otherwise there is the risk of electric shock.
- Only trained and authorized qualified professionals can replace the internal parts of the frequency converter. It is strictly prohibited to leave the wire ends or metal objects in the machine, otherwise there is the risk of fire.
- When connecting the emergency stop or safety circuit, the wiring must be checked before and after operation.
- Do not connect power cables to UVW cables.



Attention!

- When an external braking resistor or braking unit is required, refer to Chapter 2.
- The earth wire is usually a copper wire with a diameter of 3.5mm or more, and the grounding resistance is less than 10 ohms.
- There is leakage current in the inverter, the specific value of the leakage current is determined by the conditions of use, in order to ensure safety, the inverter and the motor must be grounded, and require the user to install leakage protector (RCD), it is recommended that the RCD selection is type B, the leakage current set value is 300mA.
- In order to provide input side overcurrent protection and the convenience of power outage maintenance, the inverter should be connected to the power supply through the air switch or the fuse switch.

Note

3.2.1 Main Circuit Terminal Configuration Connection Instructions

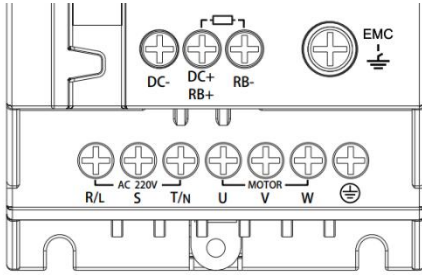

Figure 3-3 KC100-2S terminal type

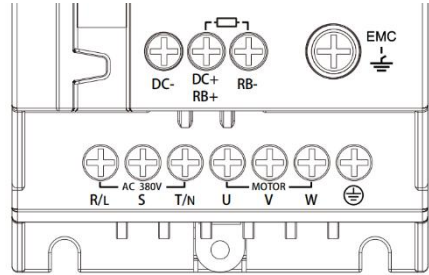

Figure 3-4 KC100-4T/5T terminal type

Table 3-2 Functions of main circuit terminals

Terminal Type	Terminal identification		Terminal name	Terminal function Description
Main circuit	R/L, S, T/N	L, N	Power supply input terminals	KC100-2S: Power input connections L, N Input voltage 1PH 200 ~ 240VAC +10%/-15% Input frequency 50 ~ 60Hz +/-5Hz
		R, S, T		KC100-4T/5T: Power input is connected to R, S, and T Input voltage 3PH 380 ~ 480VAC +10%/-15% Input frequency 50 ~ 60Hz +/-5Hz
	U, V, W		Three-phase output terminals	Three-phase AC output terminal, connected to the motor
	DC-		Negative terminal of DC bus	Common DC bus used
	DC+(RB+)	DC+	Positive terminal of DC bus	
		RB+	Braking resistor terminal	External brake resistor
	RB-	Braking resistor terminal		
⊕		Grounding terminal	Shielded ground terminal	

Select the main power circuit cable based on EN 60204-1 and IEC60364-5-52 standards. Table 3-3 Recommended specifications for main circuit cables is recommended. If peripheral cables exceed the recommended configuration range, contact us.

Table 3-3 Recommended specifications of main circuit cables

Power Model	Rated input current (A)	Rated output current (A)	RST (mm ²)	UVW (mm ²)	Ground wire (mm ²)	Screw torque (lbf-in)	Screw specification
KC100-2S-0R40G/0R75L	5.3	2.5	0.75	0.75	0.75	10	M3.5
KC100-2S-0R75G/01R5L	8.2	4.0	1.5	0.75	1.5		
KC100-2S-01R5G/02R2L	14.0	7.5	2.5	1.5	2.5		
KC100-2S-02R2G/03R7L	23.0	10.0	2.5	1.5	2.5		
KC100-4T/5T-0R75G/01R5L	3.4	2.3	0.75	0.75	0.75		
KC100-4T/5T-01R5G/02R2L	5.0	3.7	0.75	0.75	0.75		
KC100-4T/5T-02R2G/03R7L	5.8	5.5	0.75	0.75	0.75		
KC100-4T/5T-03R7G/05R5L	10.5	8.8	1.5	1.5	1.5		
KC100-4T/5T-05R5G/07R5L	14.5	13.0	2.5	2.5	2.5		

Attention!

- During the assembly process, pay attention to the fixing of the cable and do not apply stress to the connection of the main circuit terminal to prevent the inner core of the cable from breaking after long-term use.
- To effectively suppress RF interference, use cables with a shielding coverage of 85% or more.
- Increased UVW cable length can cause peak voltage at the motor end, affecting the motor windings and the insulation life of the cable. When the motor cable exceeds the Maximum Allowable cable length of the motor listed in Table 3-4, the motor and cable that comply with the IEC60034-25 standard are recommended.
- The output voltage of the inverter under the action of a long cable will generate higher harmonic voltages. If the output voltage exceeds the Maximum Allowable cable length of the motor listed in Table 3-4, add a reactor at the output end.

Note

Table 3-4 Maximum Allowable cable lengths for the motor

Inverter models	Maximum allowable length of motor cable (m)
KC100-2S-0R40G/0R75L	50
KC100-2S-0R75G/01R5L	50
KC100-2S-01R5G/02R2L	50
KC100-2S-02R2G/03R7L	50
KC100-4T/5T-0R75G/01R5L	50
KC100-4T/5T-01R5G/02R2L	50
KC100-4T/5T-02R2G/03R7L	50
KC100-4T/5T-03R7G/05R5L	50
KC100-4T/5T-05R5G/07R5L	70

3.2.2 Recommended Fuses, Contactors, And Circuit breakers

Attention!

- To prevent electric shock, do not power on the product or operate peripherals immediately after the product has blown a fuse or caused the circuit breaker to trip, at least until the time specified on the warning label. This could result in death or serious injury or damage to the product.
- In order to meet the requirements of EN61800-5-1 and UL61800-5-1 standards, it is necessary to connect fuses and circuit breakers on the input side to prevent accidents caused by short circuits in the internal circuit.

Note

Table 3-5 Recommended specifications for fuses, contactors, and circuit breakers

Model	Fuse	Contactor	Circuit breaker
		Rated Current (A)	
KC100-2S-0R40G/0R75L	12	9	10
KC100-2S-0R75G/01R5L	20	12	16
KC100-2S-01R5G/02R2L	35	25	32
KC100-2S-02R2G/03R7L	50	32	40
KC100-4T/5T-0R75G/01R5L	10	9	6
KC100-4T/5T-01R5G/02R2L	15	9	10
KC100-4T/5T-02R2G/03R7L	20	12	13
KC100-4T/5T-03R7G/05R5L	30	26	25
KC100-4T/5T-05R5G/07R5L	40	26	32

3.2.3 CN2 Control circuit terminal configuration connection instructions

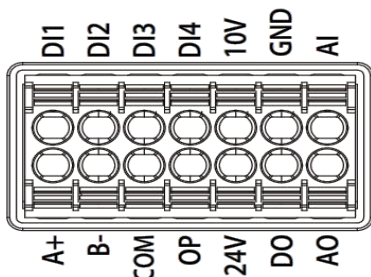

Figure 3-5 Control terminal type

Table3-6 Function description of control loop terminals

	Interface name	Function definition	Specifications
Control circuit	DI1-DI4	Multifunctional digital input	Compatible with bipolar input, support NPN and PNP connection, the effective level input voltage range: 9V~30V DI-DI3 is a low speed input with an input impedance of 4.7kΩ and a maximum input frequency of 200Hz DI4 as a high speed pulse input terminal has an input impedance of 2.2kΩ and a maximum input frequency of 50kHz
	DO	Digital output	High speed pulse output terminal Maximum operating voltage :30VDC Max output current :50mA Maximum output frequency 50kHz Also as open collector output terminal
	+ 24 V	+ 24 V	External 24VDC power supply Output voltage range: 24V±10% Maximum current: 200mA
	COM	24V power supply ground	Interior isolated from GND
	OP	Multifunction input common end	The factory default is short-circuited with +24V. When using external signals to drive DI1~DI4, the OP needs to be connected to the external power supply and disconnected from the +24V power terminal
	+10V	+10V analog voltage output	External 10V analog power supply Output voltage range: 10V±10% Maximum current: 10mA
	GND	Analog ground	Internally isolated from COM
	AI	Analog input	12-bit resolution Input voltage/current range: 0 ~ 10V/0 ~ 20mA Select the input signal type via the dip switch Input impedance for voltage input: 20kΩ Input impedance for current input: 500Ω
	AO	Analog output	Support 0 ~ 10V/0 ~ 20mA output Select the output signal type through the dip switch The maximum current in voltage mode is 2mA, corresponding to load impedance > 5kΩ Load impedance < 500Ω in current mode, default voltage mode is 0 ~ 10V
	TA-TB-TC	Relay Output	Normally closed: TA-TB Normally open: TA-TC Contact load: 3A/250V AC, 1A/30V DC
	A +	485 Communication positive signal	RS485 communication, support standard Modbus RTU protocol
	B -	485 communication negative signal	

Table 3-7 Recommended specifications for control circuit cables

Port name	Function definition	Terminal type	Cable specifications (mm ²)	Wiring requirements
A+/B-	485 Communication signal	Spring type terminal	0.2 to 0.5	Shield twisted pair
DI1 to DI4	Multifunctional digital input			Shielded twisted pair
DO	High speed pulse output			Shielded twisted pair
+24V/COM	24V power output			Shielded twisted pair
+10V/GND	10V power output			Shielded twisted pair
AI	Analog input			Shielded twisted pair
AO	Analog output			Shielded twisted pair
TA/TB/TC	Relay output	0.2 to 1.5	Ordinary wires	

3.2.2.1 Use Of Harness Grooves

The control wire can be led into the conductor groove to avoid confusion in wiring and ensure neat wiring.

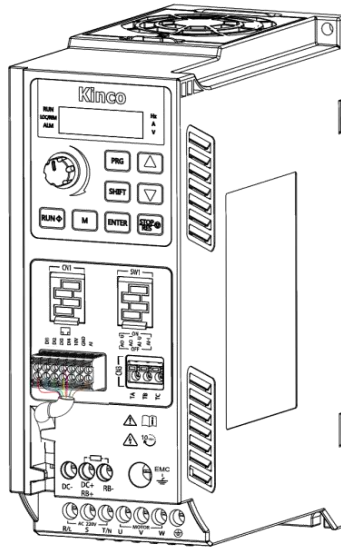

Figure 3-6 Schematic diagram of the wiring harness of the control circuit

3.2.2.2 Analog Output Wiring

The AO terminal external analog meter can indicate a variety of physical quantities, and the output signal type is selected by the dip switch.

Typical wiring methods are shown in the following figure:

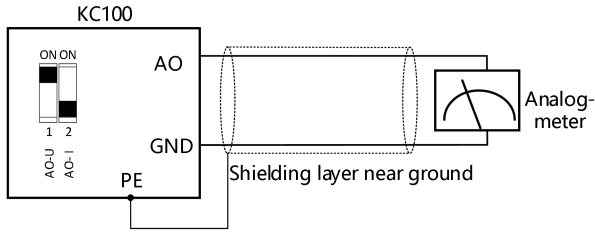

Figure 3-7 Wiring method of analog voltage output

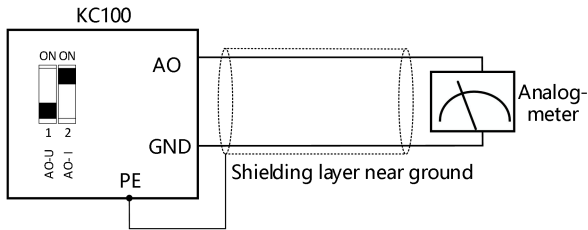

Figure 3-8 Wiring method of analog current output

3.2.2.3 Wiring Method Of Analogue Input

AI terminals accept analog voltage or current single-ended input, voltage/current input by the dip switch to select the input signal type.

Typical wiring methods are shown in the figure below:

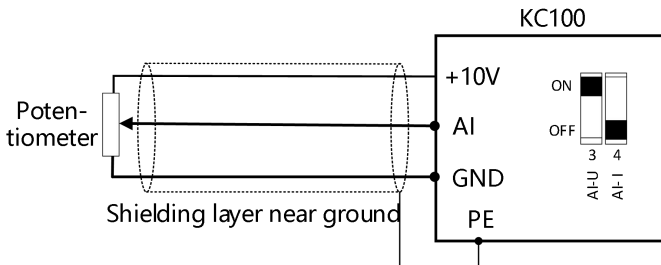

Figure 3-9 Wiring method for external input of +10V power supply

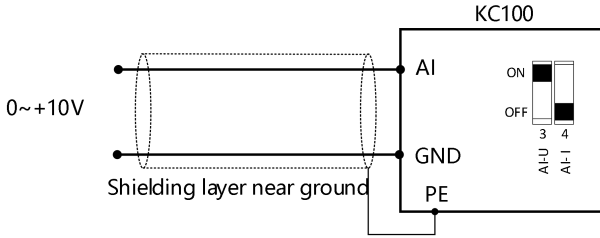

Figure 3-10 Wiring method for external input of analog voltage

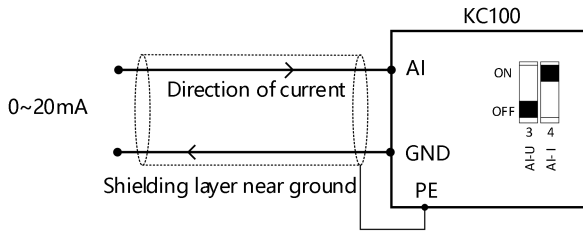

Figure 3-11 Wiring method for external input of analog current

3.2.2.4 Wiring Method For Multifunctional Digital Inputs

KC100 multi-function input terminal compatible with bipolar input, support NPN and PNP connection, the effective level input voltage range: 9V~30V

DI1-DI3 is the low speed input, and DI4 is the high speed input channel.

Typical wiring methods are shown in the following figure:

1. Dry contact method

1) Use the 24V power supply inside the AC drive

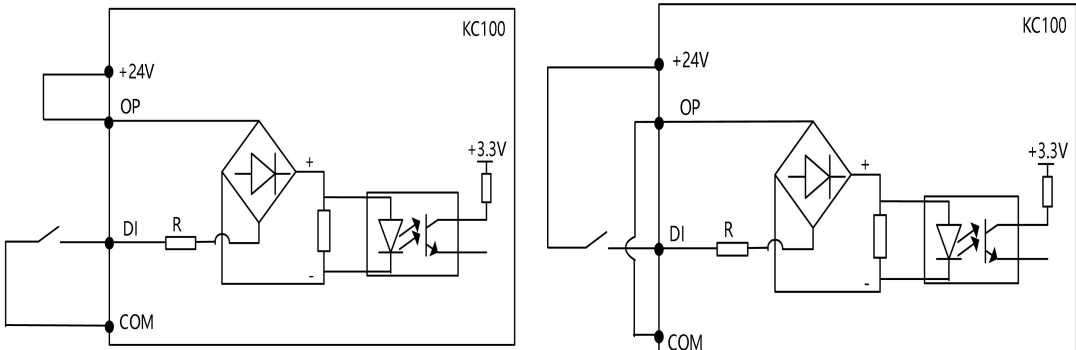

The input impedance of low-speed channel DI1-DI3 is 4.7kΩ

The input impedance of high-speed channel DI4 is 2.2kΩ

The input impedance of low-speed channel DI1-DI3 is 4.7kΩ

The input impedance of high-speed channel DI4 is 2.2kΩ

Figure 3-12 The connection method of using the internal 24V power supply

2) Use an external power supply (the power supply must meet the UL Class 2 standard, and a 4A fuse needs to be added to the power supply and interface).

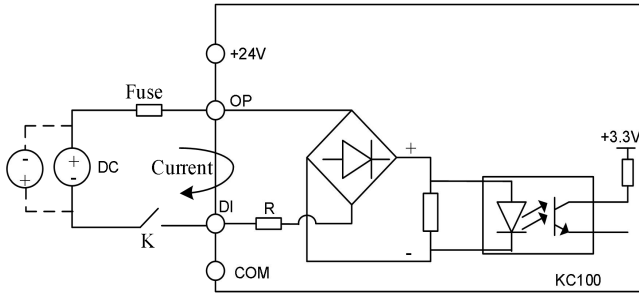

Figure 3-13 Use the connection method of external power supply

2. Source (drain) method

1) Use the internal +24V power supply of the AC drive, and the external controller is an NPN type common emitter output connection method.

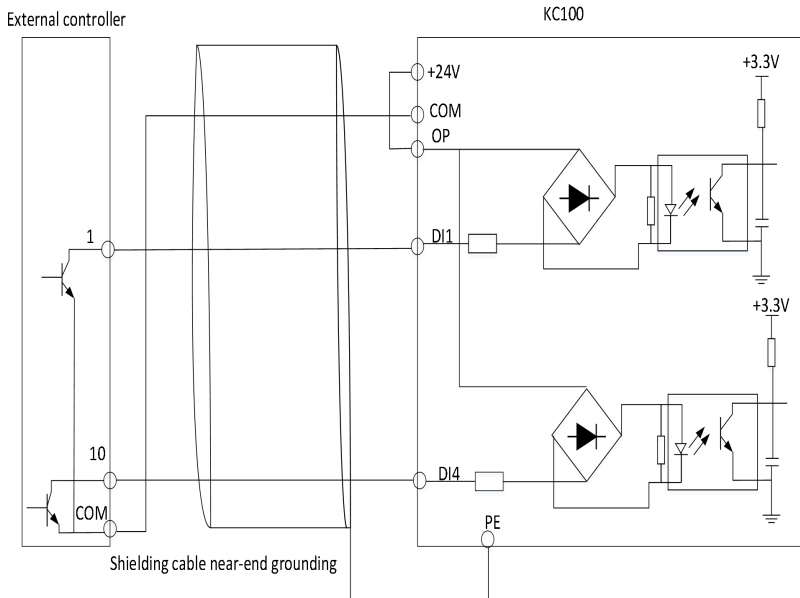

Figure 3-14 Source connection of the +24V power supply in the AC drive

2) Use the internal +24V power supply of the AC drive, and the external controller is a PNP type common emitter output connection method (note that the connection line between the OP and the 24V terminal is removed)

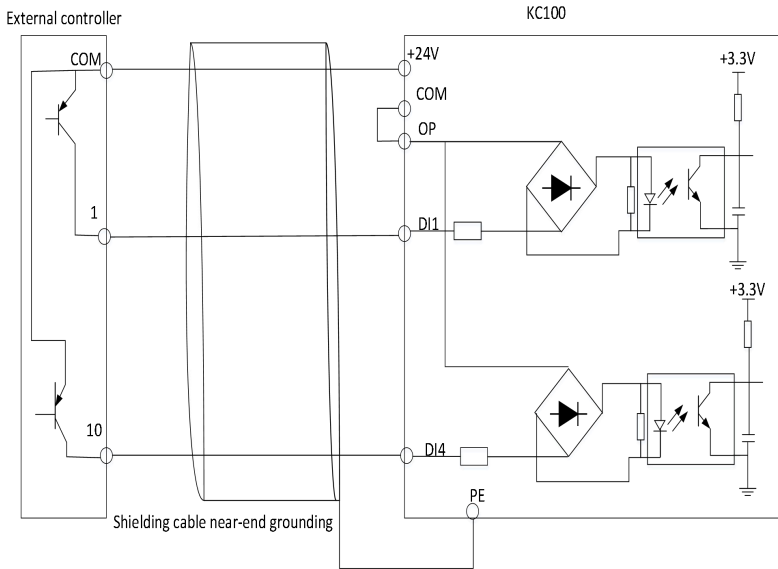

Figure 3-15 Drain connection of the +24V power supply inside the AC drive

3) Use the source connection method of external power supply: (note that the connection line between the OP and the 24V terminal is removed)

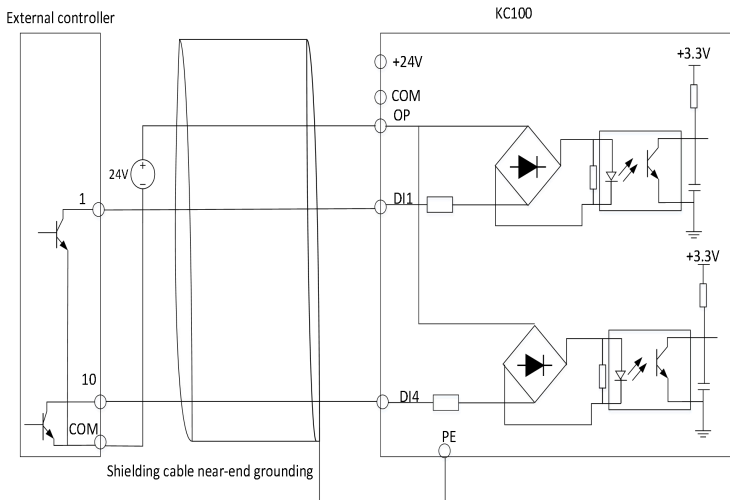

Figure 3-16 Source connection of an external power supply

4) Use the drain connection method of the external power supply (note that the connection line between the OP and the 24V terminal is removed)

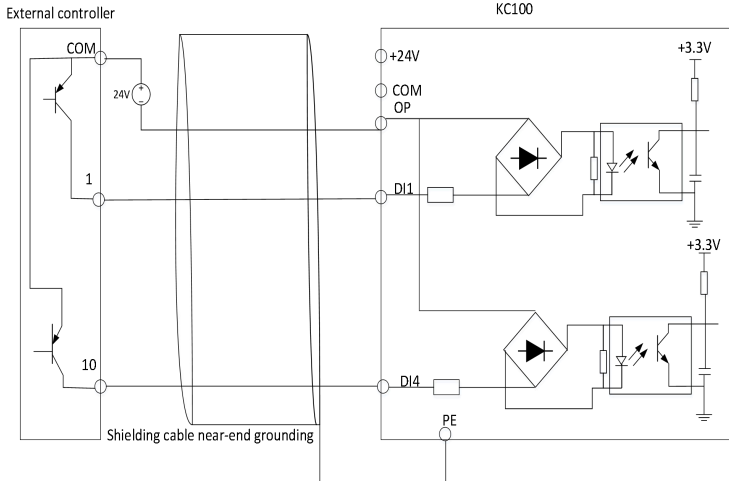
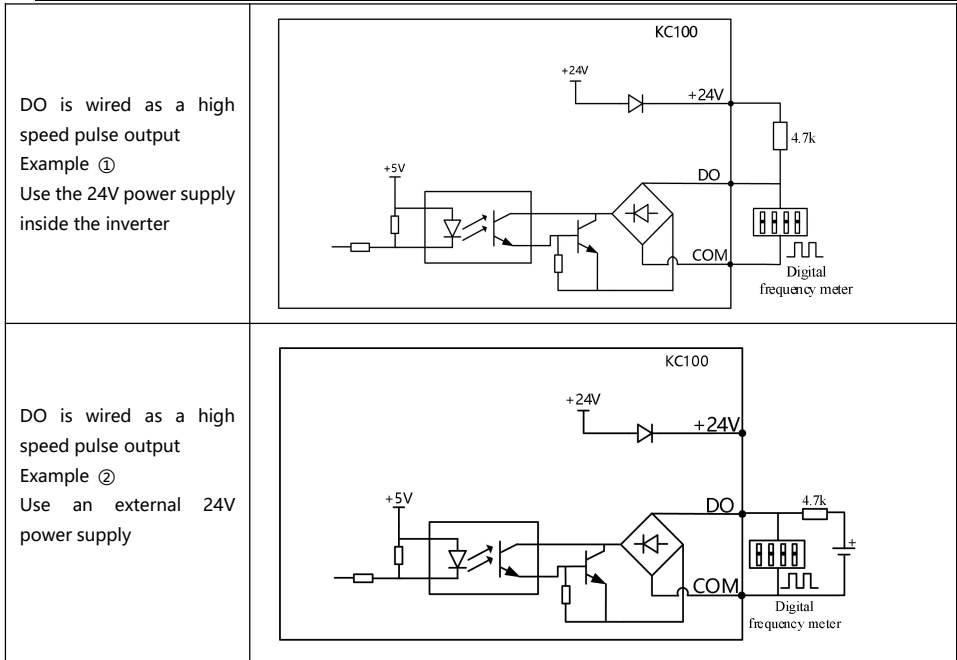

Figure 3-17 Drain connection of an external power supply

3.2.2.5 Wiring Method For High Speed Pulse Output

When the high-speed pulse output DO is connected to the relay control, the relay coil should be reversed in parallel with the continuous current diode at both ends. The maximum output current of the DO output outlet is 50mA.

<p>DO is wired as a multi-function output Example ① Use the 24V power supply inside the inverter</p>	
<p>DO is wired as a multi-function output Example ② Use an external 24V power supply</p>	



3.2.2.6 Relay Output Wiring

If the inductive load is driven (such as electromagnetic relay, contactor), the surge voltage absorption circuit should be installed; Such as: RC absorption circuit (note that its leakage current should be less than the control contactor or relay holding current), varistor, or continuous current diode (for DC electromagnetic circuit, must pay attention to the polarity when installing). The components of the absorbing circuit should be installed near the coil ends of the relay or contactor.

3.2.4 Dip Switch Function Legend And Description

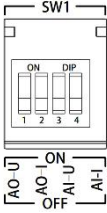
Dip Switch Type	Bit number	Feature	Function Description	Remarks
	1	A0-U	0V ~ 10V voltage output	Can only choose between AO-U and AO-I ON is valid, OFF is invalid, can not be the same as ON
	2	A0-I	0mA to 20mA current output	
	3	A1-U	0V ~ 10V input	Can only choose between AO-U and AO-I ON is valid, OFF is invalid, can not be the same as ON
	4	A1-I	0mA to 20mA input	

4 Keyboard Layout And Operating Instructions









4.1 Keyboard Layout

4.1.1 Built-in Keyboard



Figure 4-1 Schematic diagram of the LED operating panel

Table 4-1 Description of LED keyboard keys

LED	Features
	Clockwise rotation increases the operating value, counterclockwise rotation decreases the operating value.
	Enter the function menu interface when standby or running; When the parameter is in the modified state, press the key to exit the modification.
	Standby or running switch display stop display parameter or running display parameter, you can view the definition by F15.10-F15.19; Press this key to shift to change the digit to the right when the parameter is changing status.
	UP,DOWNM operation bits.
	When run/stop is controlled by the keyboard, press this key to run the AC drive and the motor is forward.
	When the command given channel is keyboard control, press the key to stop the inverter; Other command channels can be defined by parameter F15.01 whether they are valid; Fault state Press the key to reset the inverter.
	Select the function of this key by parameter F15.00[Keyboard Multifunction Key Selection].
	Press this key after changing the value to confirm the change.

4.1.1.1 Status Indicator



























In the following table, the indicator  is on, the indicator  is off, and the indicator  is blinking.













Table 4-2 Description of indicators on the operation panel

Indicator status		Status instructions	
RUN Run indicator		Off: Shutdown does not run	
		On: The machine is running in positive rotation	
		Blinking: Reverse running	
LOC/REM Command source indicator		Off: Keyboard panel control	
		On: Terminal control	
		Blinking: Communication control	
ALM Fault indicator		Off: No fault occurs	
		Blinking: The AC drive is faulty or the inverter in the self-learning state	
 Hz  A  V	Frequency display	 Hz  A  V	Voltage display
 Hz  A  V	Current display	 Hz  A  V	Rotate speed display
 Hz  A  V	Percentage display		

4.1.1.2 Data Display





The operation panel has a total of 5 digits LED data display, which can display the setting frequency, output frequency, various monitoring data and alarm code.

Table 4-3 LED data display and actual data corresponding table

LED Display	Actual correspondence	LED display	Actual correspondence	LED display	Actual correspondence	LED display	Actual correspondence
	0		9		H		P
	1		A		h		q
	2		b		l		r

3	3	0	C	U	J	0	T
4	4	2	c	8	k	8	t
5	5/S	8	d	U	L	U	U
6	6	8	E	7	N	0	u/v
7	7	8	F	7	n	9	y
8	8	0	G	0	o		

Table 4-4 Special LED status display on the operation panel

LED Display	Meaning	LED display	Meaning
	Restore factory parameters		Download keyboard parameters to the control board
	Control board parameters are uploaded to the key board		EST: Parameter tuning process The last two digits of the nixie tube change the number with the tuning step

4.1.2 External Keyboard

External keyboard is an optional accessory, connected to the frequency converter external keyboard interface (CN1) by network cable, in addition to the basic control, but also support parameter upload and download function (see 5.11.2), compared with the built-in keyboard to add independent positive and negative switch keys, positive and negative indicator, and current limiting status indicator, in addition, The digital tube display and other keys of the external keypad are the same as those of the internal keyboard.

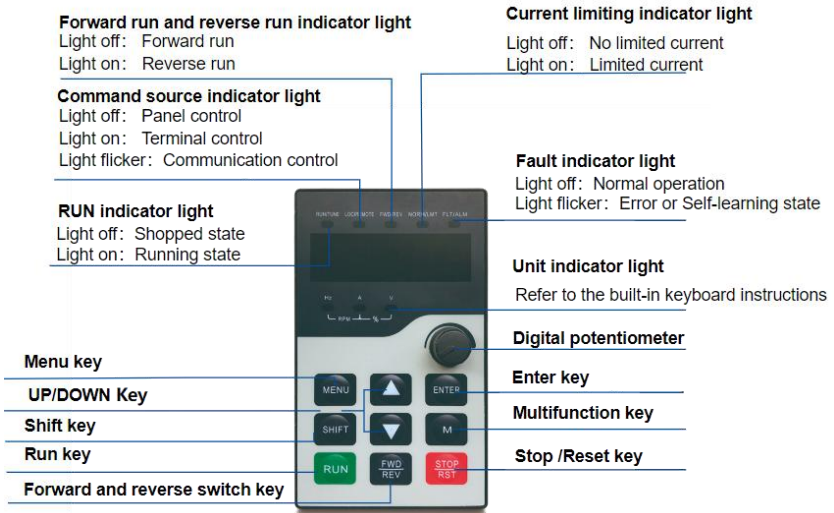





Figure 4-2 Layout diagram of the external keyboard

Attention:

- 1、 the external keyboard interface and RS485 terminal for the same 485, can not be used at the same time;
- 2、 when the external keyboard is connected, the built-in keyboard operation is frozen and only displayed.

4.2 Menu Description

The operation panel adopts the 3-level menu structure for parameter setting and other operations. After entering the menu of each level, when the display bit flashes, you can press the UP  key, DOWN  key, SHIFT  key to set.

The three level menus are as follows: Level-1 menu: Parameter group; Level-2 menu: Parameter; Level-3 menu: parameter Settings and the initial monitoring interface.

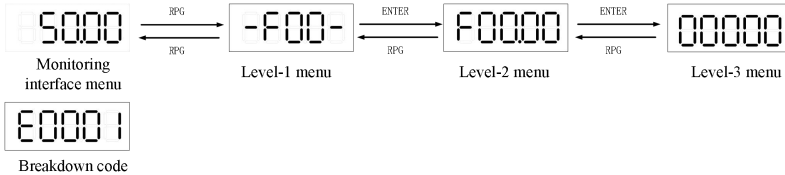

Figure 4-3 Operation hierarchy diagram of the standard menu

When the AC drive menu mode selects the check menu, the LED panel only displays parameters different from the factory value, that is, there is no first-level menu.



Figure 4-4 Operation hierarchy diagram of level of verify menu

Table 4-5 Menu mode selection parameters

Parameter Code (address)	Name	Content	Parameter Description
F00.02 (0x0002)	Menu Mode selection	0: Standard menu 1: Verify menu	0: Standard menu ,Displays all parameters. 1: Verify menu , Display parameters that differ from the factory values.

4.3 Status Parameter Display

When in the monitoring interface menu, you can switch by the keyboard SHIFT key to display the running shutdown parameters.

In the running state, you can view the running state parameters by holding down SHIFT key. The default display status parameters are: operating frequency, given frequency, output current, output voltage, bus voltage.

In the shutdown state, you can view the status parameters by holding down SHIFT key. The default display status parameters are: set frequency, bus voltage, AI voltage, keyboard potentiometer voltage.

If you want to view other status parameters, please refer to the following running shutdown parameter display Settings.

Table 4-6 LED running display parameters

Parameter code (address)	Name	Content	Parameter Description
F15.10 (0x0F0A)	LED display 1 in running state	0: Disabled	<p>In the running or shutdown state, press the SHIFT key on the keyboard operation panel to view the status value of up to 5 running display parameters of the AC drive in real time.</p>
F15.11 (0x0F0B)	LED display 2 in running state	1: Main frequency X 2: Auxiliary frequency Y 3: Setting frequency (after acceleration and deceleration)	
F15.12 (0x0F0C)	LED display 3 in running state	4: Reference frequency (target value) 5: Running frequency 6: Output voltage 7: Output current 8: DC-Bus voltage 9: Setting torque 10: Output torque	
F15.13 (0x0F0D)	LED display 4 in running state	11: Output power 12: Setting speed 13: Running speed 14: AC drive operating status	
F15.14 (0x0F0E)	LED display 5 in running state	15: AC drive temperature 16: Motor temperature 17: DI state 18: DO state	
F15.15 (0x0F0F)	LED display 1 in stop state	19: AI voltage before correction 20: AI voltage 25: Operating panel potentiometer voltage before correction	
F15.16 (0x0F10)	LED display 2 in stop state	26: Operating panel potentiometer voltage 27: AO output	
F15.17 (0x0F11)	LED display 3 in stop state	29: Input PULSE frequency (0.01KHz) 30: Output PULSE frequency (0.01KHz)	
F15.18 (0x0F12)	LED display 4 in stop state	31: V/f separation target voltage 32: V/f separation output voltage 33: Communication setpoint 34: PID reference 35: PID feedback	
F15.19 (0x0F13)	LED display 5 in stop state	36: PID error 37: PID integral value 38: PID output 39: PLCstate 40: Count value 45: Power factor angle 46: Motor speed feedback 48: Load speed 57: Remaining running time	

		58: Current power-on duration 59: Current running duration 60: High-order bits of accumulative power consumption 61: Low-order bits of accumulative power consumption 62: High-order bits of current power consumption 63: Low-order bits of current power consumption	
--	--	---	--

4.4 Parameter Setting

Application examples:

Change the parameter keypad number given frequency F01.10 from 50.00Hz to 15.00Hz.

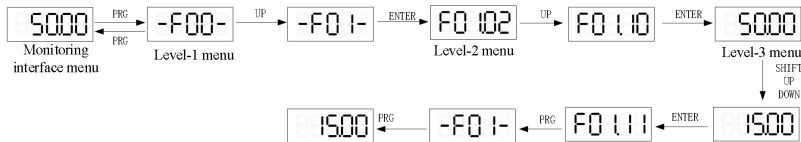

Figure 4-5 Schematic diagram of changing the operating frequency

During the level-3 menu operation, you can press the PRG key or ENTER key to return to the Level-2 menu. The difference between the two is:

1. Press ENTER key to save the setting parameter and return to the secondary menu, and automatically move to the next parameter;
2. Press PRG key to abandon the current parameter modification and directly return to the upper-level menu corresponding to the current parameter.

In the third level menu state, if the parameter setting value does not blink, it means that the parameter value cannot be set. The possible reasons are as follows:

1. The parameter is an unchangeable parameter;
2. The AC drive is in the running state, the parameter cannot be changed in the running state, and can be changed only after stopping;
3. The user password is currently set.

4.5 M Multifunction Key Operation

The M key on the operation panel is a Multi-function key, and the function of the Multi-function key can be set by parameter F15.00. In the shutdown or running state, press this key to switch the command channel, forward and reverse operation, and forward and reverse click operation.

Table 4-7 Function key selection parameters

Parameter code (address)	Name	content	Parameter Description
F15.00 (0x0F00)	Multi-function key	0: Multi-function key disabled 1: Switch between operating panel command channel and remote command channel (terminal command channel or communication command channel) 2: Forward and reverse switching 3: Forward jog 4: Reverse jog	<p>The M key on the operation panel is a Multi-function key, and the function of M key is set by this parameter.</p> <p>0: The M key is invalid This key is not functional.</p> <p>1: Switch between the command channel of the operation panel and the remote command channel (terminal command channel or communication command channel)</p> <p>F01.03 Set to 0(Operation panel), no effect after pressing M key; F01.03 is set to 1(Terminal), and the switch between terminal and operation panel can be realized by M key; F01.03 is set to 2(Communication), and the switch between communication and operation panel can be realized by M key.</p> <p>2: Forward and reverse switch Use the M key to switch the direction of the frequency command. This feature only works if the run command channel is the Operations panel.</p> <p>3: Forward turn click Positive turn point motion (FJOG) is achieved through the M key. This feature only works when the run command channel is the operation panel.</p> <p>4: Reverse the tap Reverse dotting via the M key (RJOG) This feature only works when the run command channel is the operation panel.</p>

4.6 The Operation Panel Drives The Motor

Press the RUN and STOP/RST keys on the operation panel to start and stop the motor.

Operation steps:

1. Check before power-on;

Check the installation and wiring according to the installation manual. For detailed checks, refer to the Pre-power-on check in the Installation Guide.

2. Press the power switch to switch on the AC drive;
3. Check the display 50.00 on the operation panel, indicating successful power-on;



Figure 4-6 AC drive power-on display

4. Press the RUN key to start the motor, and the motor shaft starts to accelerate and rotate. At the same time, the panel displays the current running frequency, as shown in the picture below. After the acceleration is completed, the frequency value is displayed as 50.00. Hold down the SHIFT key to switch the running state parameters displayed;



Figure 4-7 Steady operation display of the AC drive

5. Press the STOP key to slow down the motor and stop the machine.

5 Function Introduction

5.1 Operation Command Setting

5.1.1 Run command channel setting

Operation commands are used to control the start, stop, forward run, reverse run, and jog operations of the AC drive. Three command sources are available: operating panel, terminal I/O, and communication.

You can select the operation command source by setting F01.03.

Table 5-1 Operation command source parameter

Parameter code (address)	Name	Content	Default (Value Range)	Description
F01.03 (0x0103)	Operation command source	0: Operating panel control 1: Terminal I/O control 2: Communication control	0 (0~2)	This parameter defines the source of the AC drive control commands, such as run, stop, forward run, reverse run, and jog. 0: Operating panel control Control commands are input using the RUN, STOP/RES, and M keys on the operating panel. This mode is suitable for initial commissioning. 1: Terminal I/O control Control commands are input through the DI terminals of the AC drive. The DI terminal control commands can be set based on different scenarios, such as start/stop, forward/reverse run, jog, two-wire/threewire control, and multi-speed. It is suitable for most applications. 2: Communication control Control commands are input through remote communication. This mode applies to remote control or centralized control of multiple equipment.

5.1.2 Operating Panel Control

When F01.03 is set to 0, the start and stop of the AC drive are controlled by pressing keys (RUN and STOP/RES) on the operating panel.

When you press RUN, the AC drive starts to run (the RUN indicator is on).

When you press STOP/RES during running, the AC drive stops running (the RUN indicator is off).

5.1.3 Terminal I/O Control

1. When F01.03 is set to 1, operation command sources select Terminal I/O Control.

2. When F08.00 is set to 1 (forward run) or set to 2 (reverse run), the start and stop of the AC drive are controlled through terminals.

3. DI is assigned with the Three-wire operation control function, and You can set F08.10 to select a terminal control mode.

Four terminal I/O control modes are available,

including two-wire mode 1, two-wire mode 2, three-wire mode 1, and three-wire mode 2.

Table 5-2 Terminal control mode parameter

Parameter code (address)	Name	Content	Default (Value Range)	Description
F08.10 (0x080A)	Terminal control mode	0: two-wire mode 1 1: two-wire mode 2 2: three-wire mode 1 3: three-wire mode 2	0 (0~3)	This parameter defines the mode in which the AC drive is controlled by external terminals.

You can use any of multi-functional input terminals DI1 to DI4 as external input terminals. You can define the functions of DI1 to DI4 by setting F08.00 to F08.03. For details, see the description of F08.00 (DI1) to F08.03 (DI4) in "7.2 List of Parameters".

Application:

DI1 is assigned with the forward run function, and DI2 is assigned with the reverse run function. Connect the forward run switch to DI1 and the reverse run switch to DI2.

Table 5-3 DI1 set to FWD, DI2 set to REV parameter

Parameter	Name	Reference	Function Description
F08.10	Terminal control mode	0	Two-wire mode 1
F08.00	DI1 function	1	Forward RUN(FWD)
F08.01	DI2 function	2	Reverse RUN(REV)
F08.02	DI3 function	3	Three-wire operation control

0: Two-wire mode 1

Integration of operation and direction. This is the most commonly used two-wire mode. The factory default is DI1(Forward RUN) and DI2 (Reverse RUN) terminal commands to determine the forward or reverse operation of the motor. See the following figure.

K1	K2	Operation command
0	0	Stop
1	0	Forward run
0	1	Reverse run
1	1	Stop

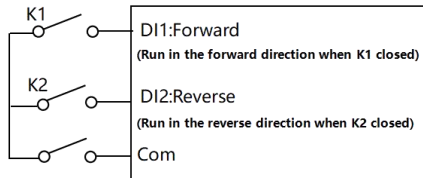
**Figure 5-1 Wiring and parameter setting for two-wire mode 1**

1: Two-wire mode 2

Separation of operation and direction. The forward run terminal DI1(Forward RUN) defined in this mode is the run enable terminal. The direction is defined by the state of the reverse run terminal DI2 (Reverse RUN). See the following figure.

K1	K2	Operation command
0	0	Stop
1	0	Forward run
1	1	Reverse run
0	1	Stop

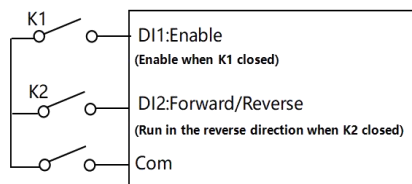
**Figure 5-2 Wiring and parameter setting for two-wire mode 2**

2: Three-wire mode 1

In this mode, the stop of the AC drive are controlled through the three-wire running control terminal (DI3), and the running command is generated by the forward run terminal DI1(Forward RUN) or the reverse run terminal DI2 (Reverse RUN), and the two control the running direction at the same time. See the following figure.

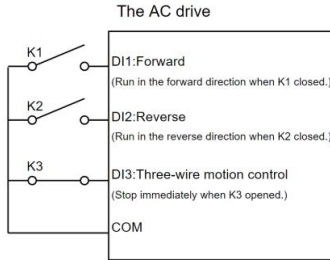

Figure 5-3 Wiring and parameter setting for three-wire mode 1

3: Three-wire mode 2

In this mode, the stop of the AC drive are controlled through the three-wire running control terminal (DI3). The running command is generated by the forward run terminal DI1(Forward RUN), and the direction is defined by the state of the reverse run terminal DI2 (Reverse RUN). The three-wire operation control terminal (DI3) is a valid input. See the following figure.

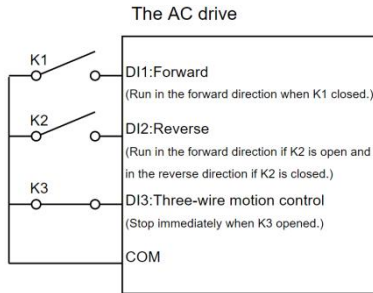

Figure 5-4 Wiring and parameter setting for three-wire mode 2

5.1.4 Communication Control

When F01.03 is set to 2, the start and stop of the AC drive are controlled through communication. When the AC drive is controlled through serial communication, the host controller must send a write command to the AC drive.

Here takes the Modbus protocol as an example to describe how to control the AC drive through communication.

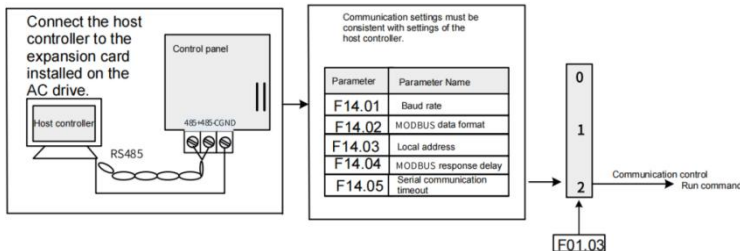

Figure 5-5 Setting commands through communication

Application :

To make the AC drive run in reverse direction, the host computer sends the write command 01 06 70 00 00 02 12 CB (hexadecimal). The following table describes the meaning of each byte in the command. (The command is in hexadecimal format.)

For other communication addresses and control commands, see "Appendix I: Modbus Protocol".

Table 5-4 Communication command 01 06 70 00 00 02 12 CB interpretation

Command	Description
01H(configurable)	AC drive address
06H	Write command
7000H	Control command communication address
0002H(reverse RUN)	Control command
12CBH	CRC check

Table 5-5 The master and slave communication commands and responses

Host Command		Slave Response	
ADDR	01H	ADDR	01H
CMD	06H	CMD	06H
High-order bits of parameter address	70H	High-order bits of parameter address	70H
Low-order bits of parameter address	00H	Low-order bits of parameter address	00H
High-order bits of data content	00H	High-order bits of data content	00H
Low-order bits of data content	02H	Low-order bits of data content	02H
CRC high-order bits	12H	CRC high-order bits	12H
CRC low-order bits	CBH	CRC low-order bits	CBH

5.2 Frequency Reference Sources

5.2.1 Setting Frequency Reference Sources

The AC drive supports three frequency references: main frequency reference, auxiliary frequency reference, and main and auxiliary frequency superposition.

5.2.2 Selecting Source of Main Frequency Reference

The AC drive supports more than 8 main frequency sources, including operating panel digital setting, AI, panel potentiometer, communication, pulse input, PID, multi-reference, simple PLC ,which can be selected by setting F01.04 (0 to 9).

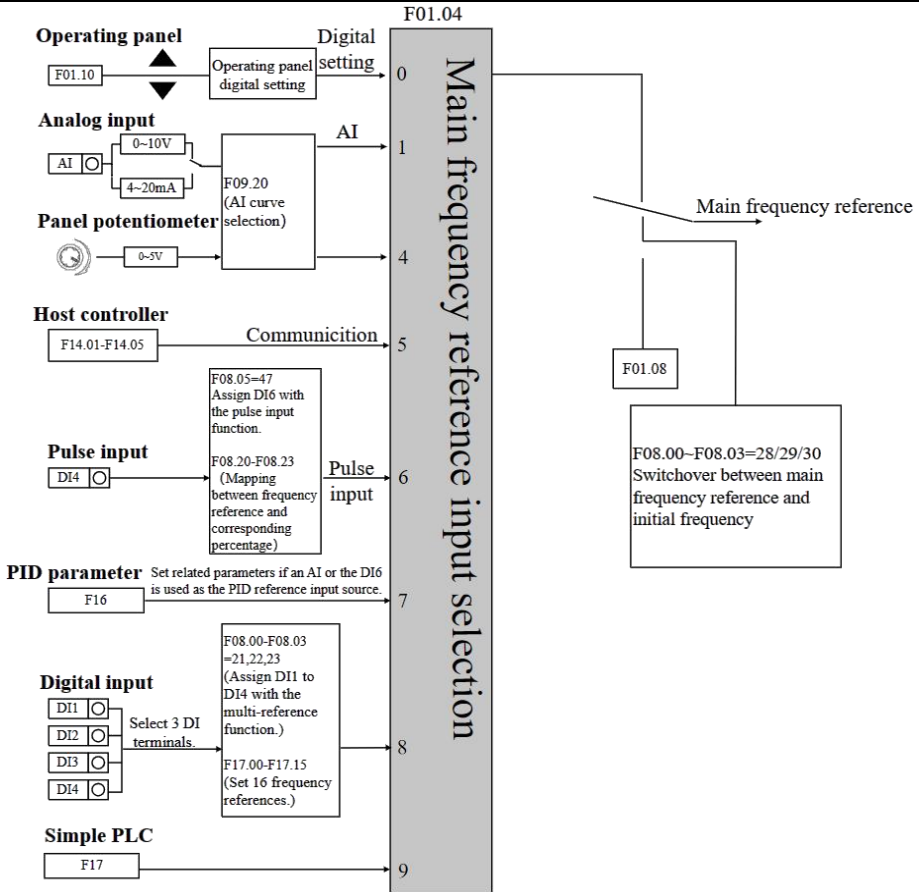

Figure 5-6 Main frequency reference selection

Table 5-6 Source of main frequency reference parameter

Parameter code (address)	Name	Content	Default (Value Range)
F01.04 (0x0104)	Main frequency source X	0: Operating panel digital setting(F01.10) 1: AI 4: Panel potentiometer 5: Communication 6: PULSE input(DI4) 7: PID 8: Multi-reference 9: Simple PLC	0 (0~9)

5.2.3 Setting Main Frequency Through Operating Panel

When the main frequency is set through operating panel (F01.04 is set to 0), the frequency can be corrected by the UP and DOWN keys. F01.17 determines whether the corrected frequency is remembered during shutdown or power failure.

Table 5-7 Frequency related parameters

Parameter code (address)	Name	Content	Default (Value Range)
F01.10 (0x010A)	Digital setting frequency	This parameter defines the Digital setting frequency.	50.00Hz (0.00Hz~F01.11)
F01.11 (0x010B)	Maximum frequency	This parameter defines the maximum output frequency of the AC drive.	50.00Hz (50.00~599.00Hz)

Table 5-8 Frequency retention parameter

Parameter code (address)	Name	Content	Default (Value Range)
F01.17 (0x0111)	Retention of digital setting of frequency	Ones: Stop retention selection 0: Non-retention 1: Retention Tens: Power down retention selection 0: Non-retention 1: Retention	00 (00~11)

5.2.4 Setting Main Frequency Through Analog Input

(AI Or Panel Potentiometer)

When the main frequency is set through analog input, AI(F01.04 is set to 1), or Panel Potentiometer(F01.04 is set to 4) can be used.

When an AI terminal is used as the frequency source(the operating panel potentiometer Settings are the same as the AI Settings), it supports a variety of AI curves. Therefore, first introduce the setting method of AI curve, and then introduce how to select the corresponding AI curve of AI terminal. See the following steps.

Table 5-9 Set the AI input primary frequency steps

Step 1: Setting AI Curve

Step	Related Parameters	Description
Step 1 Set the AI curve: Set the relationship between the AI voltage/current inputs and frequency setpoints.	F09.21~F09.28	Curve 1 setting and Curve 2 setting
Step 2 Select an AI curve for the AI terminal: Select a curve and filter time for the AI terminal.	F09.20、F09.02	AI curve selection, Filter time of AI
Step 3 Select an AI terminal as the frequency reference source: Select the AI terminal for setting the frequency reference based on terminal characteristics.	F01.04 (main frequency reference source X)	F01.04 = 1 Select AI

Two types of AI curves are available. Curve 1, and curve 2 are two-point curves, which are defined by parameters F09.21 to F09.24(Curve 1) and F09.25 to F09.28(Curve 2). The setting of the AI curve is actually set the relationship between the AI voltage/current inputs and frequency setpoints.

The following takes AI curve 1 as an example to describe the settings. The related parameters are F09.21 to F09.24.

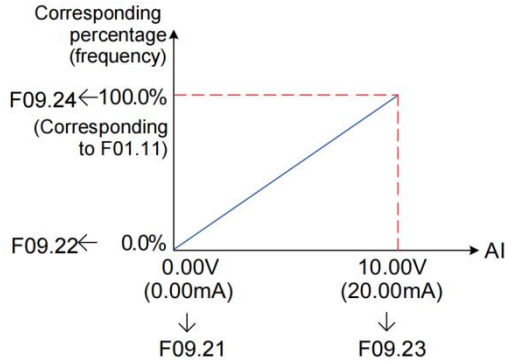

Figure 5-7 Settings of AI curve 1

When an AI terminal is used as the main frequency source, the voltage/current input setpoint 100% indicates the percentage relative to the maximum frequency (F01.11). When AI current mode input is used, 1 mA current corresponds to 0.5 V voltage, and 0 mA to 20 mA current correspond to 0 V to +10 V voltage.

Step 2: Selecting AI Curve for AI Terminal

The curves of terminals Analog Input are determined by the ones positions of F09.20.

Longer AI input filter time indicates stronger anti-interference capability but slower adjustment response. Shorter filter time indicates faster adjustment response but weaker anti-interference capability. If the onsite analog input is prone to interference, you can increase the filter time to stabilize the detected analog input. However, increasing the AI filter time will slow down the response to analog detection. Therefore, the filter time must be set properly based on actual conditions.

Step 3: Selecting AI Terminal as Frequency Reference Source

The control board provides one AI terminals and one panel potentiometer. AI provide voltage input of 0 V to 10 V or current input of 0 mA to 20 mA. The following describes how to set AI terminal as the main frequency source.

For example, assume that curve 1 is selected for AI (the ones position of F09.20 is set to 1), and AI voltage input is selected as the main frequency source. To set the frequency reference to 10 Hz to 40 Hz (corresponding to 2 V to 10 V), set the parameters according to the following figure.

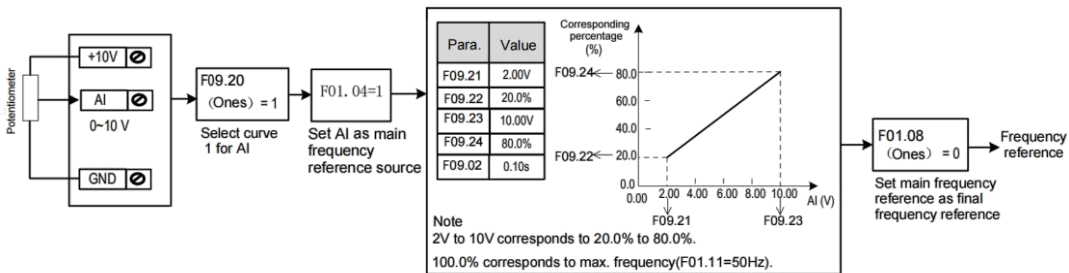

Figure 5-8 Parameter settings for AI voltage input as the main frequency source

AI can provide analog voltage input (0 V to 10 V) or analog current input (0 mA to 20 mA). When AI provides analog current input of 0 mA to 20 mA, the corresponding input voltage ranges from 0 V to 10 V. If the input current ranges from 4 mA to 20 mA, the corresponding input voltage ranges from 2 V to 10 V.

Table 5-10 AI terminal function parameter

Parameter code (address)	Name	Content	Default (Value Range)
F09.02 (0x0902)	Filter time of AI	This parameter defines the filter time of the analog signal to be filtered to eliminate interference signals.	0.10s (0.00s~10.00s)
F09.11 (0x090B)	Filter time of the panel potentiometer	This parameter defines the filter time of the analog signal to be filtered to eliminate interference signals.	0.10s (0.00s~10.00s)
F09.20 (0x0914)	AI curve selection	Ones: AI Thousands: Panel Potentiometer 1: Curve 1 2: Curve 2	0X2111 (0X1111 ~ 0X2112)
F09.21 (0x0915)	Minimum input of AI curve 1	This parameter defines Minimum input of AI curve 1, Voltage signals below this value are treated as the minimum value.	0.00V (0.00~F09.23)
F09.22 (0x0916)	Percentage corresponding to minimum input of AI curve 1	This parameter defines the Percentage corresponding.	0.0% (-100.0%~100.0%)
F09.23 (0x0917)	Maximum input of AI curve 1	This parameter defines Maximum input of AI curve 1, Voltage signals higher than this value are treated as the maximum value.	10.00V (F09.21~10.00V)
F09.24 (0x0918)	Percentage corresponding to maximum input of AI curve 1	This parameter defines the Percentage corresponding.	100.0% (-100.0%~100.0%)
F09.25 (0x0919)	Minimum input of AI curve 2	This parameter defines Minimum input of AI curve 2, Voltage signals below this value are treated as the minimum value.	0.00V (0.00V~F09.27)
F09.26 (0x091A)	Percentage corresponding to minimum input of AI curve 2	This parameter defines the Percentage corresponding.	0.0% (-100.0%~100.0%)
F09.27 (0x091B)	Maximum input of AI curve 2	This parameter defines Minimum input of AI curve 2, Voltage signals higher than this value are treated as the maximum value. .	10.00V (F09.25~10.00V)
F09.28 (0x091C)	Percentage corresponding to maximum input of AI curve 2	This parameter defines the Percentage corresponding.	100.0% (-100.0%~100.0%)

5.2.5 Setting Main Frequency Through Communication

The Modbus communication protocols are supported by KC100. When Modbus is used for communication, set F14.01, F14.02, and F14.03 to specify the baud rate, data format, and local address, respectively.

Application

Step 1: Set F01.04 to 5 to select communication as the main frequency source.

Step 2: Send a write command to the AC drive from the host controller.

Here takes the Modbus protocol as an example to describe how to set the main frequency through communication. For example, to set the frequency to 50.00 Hz through communication, send the write command 01 06 70 10 27 10 88 F3.

Table 5-11 Communication command 01 06 70 10 27 10 88 F3 interpretation

Byte	Description
01H(configurable)	AC drive address
06H	Write command
7010H	Control command communication address
2710H(which is equivalent to 10000 in decimal, refers to 100% of the maximum frequency)	Target frequency
88F3H	CRC check

Similarly, to set the frequency to 25.00 Hz through communication, send the write command 01 06 70 10 13 88 9F 99.

In this command, 13 88 is the hexadecimal number converted from 5000, refers to 50% of the maximum frequency.

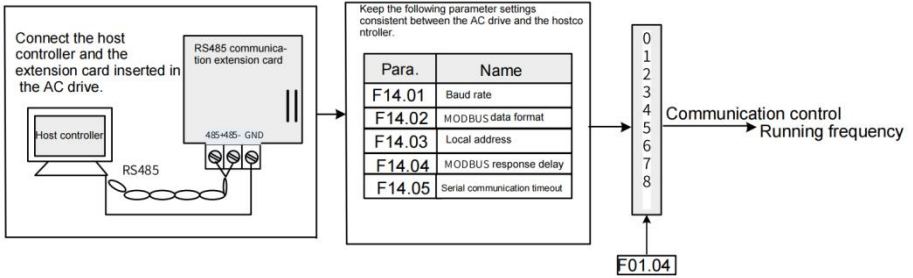

Figure 5-9 Parameter settings when the main frequency is set through communication

Table 5-12 Correspondence between host commands and slave responses

Host Command		Slave Response	
ADDR	01H	ADDR	01H
CMD	06H	CMD	06H
High-order bits of parameter address	70H	High-order bits of parameter address	70H
Low-order bits of parameter address	10H	Low-order bits of parameter address	10H
High-order bits of data content	27H	High-order bits of data content	27H
Low-order bits of data content	10H	Low-order bits of data content	10H
CRC high-order bits	88H	CRC high-order bits	88H
CRC low-order bits	F3H	CRC low-order bits	F3H

The frequency range corresponding to the given frequency range is 0% ~ 100.00%(100.00% corresponds to the maximum frequency). Suppose F01.11 "Max frequency" is set to 50.00Hz. If the frequency of the write command is 2710H, convert the decimal to 10000. Then the actual written frequency value is 50.00*100%=50.00Hz.

5.2.6 Setting Main Frequency Through Pulse Input

When the pulse input is selected as the main frequency source, the pulse reference must be obtained from multi-functional input terminal DI4.

The pulse reference signal specifications are 0-30 V (voltage range) and 0-50 kHz (frequency range).

Table 5-13 The steps for setting the main frequency through pulse input(DI4)

Step	Related Parameters	Description
Select pulse input(DI4) as the main frequency source.	F01.04、F08.03	Set F01.04 to 6 to select pulse input(DI4) as the main frequency source. Set F08.03 to 47 to assign DI4 with the pulse frequency input function.
Set the pulse reference curve, which defines the mapping between the pulse input of DI4 and the frequency setpoint.	F08.20~F08.23	Typical setup curve ^[1]
Set maximum frequency.	F01.11	When the pulse input is selected as the main frequency source, 100% the percentage corresponding refers to the relative maximum frequency F01.11.
Set filter time of the set frequency.	F08.24	This parameter defines the filter time of the set frequency.

【1】 When the pulse input is selected as the main frequency source, a typical setup curve is shown below.

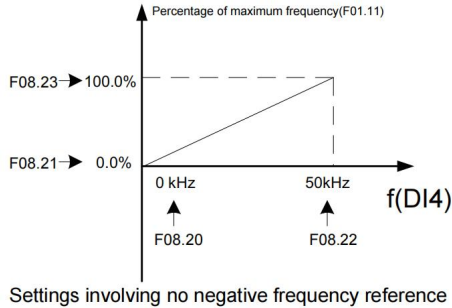

Figure 5-10 Typical curves for DI4 as frequency reference

Table 5-14 High speed pulse input setting parameters

Parameter code (address)	Name	Content	Default (Value Range)
F08.20 (0x0814)	Minimum pulse input frequency	This parameter defines Minimum pulse input frequency.	0.00kHz (0.00kHz~F08.22)
F08.21 (0x0815)	Percentage corresponding to minimum pulse input frequency	This parameter defines the Percentage corresponding.	0.0% (-100.0%~100.0%)
F08.22 (0x0816)	Maximum pulse input frequency	This parameter defines Maximum pulse input frequency.	50.00kHz (F08.20~100.00kHz)
F08.23 (0x0817)	Percentage corresponding to maximum pulse input frequency	This parameter defines the Percentage corresponding.	100.0% (-100.0%~100.0%)
F08.24 (0x0818)	Pulse filter time	This parameter defines Pulse filter time.	0.10s (0.00s~10.00s)

5.2.7 Setting Main Frequency Through PID

As a general process control method, PID control is a closed-loop mechanism in which each controlled variable is stabilized at the target level through proportional, integral, and differential calculation of the difference between the feedback signal and the target signal of the controlled variable. The output of PID control is used as the running frequency, which generally applies to on-site closed-loop control applications, such as constant pressure closed-loop control and constant tension closed-loop control.

Proportional gain Kp: Once the deviation between PID output and input occurs, the PID controller adjusts the output to reduce the deviation. The speed at which the deviation decreases depends on the proportional coefficient Kp. A larger Kp tends to reduce the deviation faster, but may cause system oscillation, especially at large hysteresis. A smaller Kp indicates lower possibility of oscillation but also slower adjustment. (The value 100.0 indicates that when the difference between PID feedback and reference is 100.0%, the adjustment amplitude of the PID controller on the output frequency reference is the maximum frequency.)

Integral time Ti: It determines the integral adjustment intensity of the PID controller. Shorter integral time indicates greater adjustment intensity. (Integral time refers to the time required for continuous adjustment of the integral regulator to reach the maximum frequency when the deviation between the PID feedback and reference is 100.0%.)

Derivative time Td: It defines the deviation variation adjustment intensity of the PID controller. Longer derivative time indicates greater adjustment intensity. (Derivative time refers to the time within which the feedback value change

reaches 100.0%, and the adjustment amplitude reaches the maximum frequency.)

Application

Step 1: Set F01.04 to 7 to select PID as the main frequency reference input source.

Step 2: Set F16.00 to select a source of PID target reference. If F16.00 is set to 0, set F16.01 (digital setting of PID).

The value 100% of this parameter corresponds to the maximum value of PID feedback.

Step 3: Set F16.03 to select a PID feedback source.

Step 4: Set F16.16 to select a PID action direction.

The following figure shows the logic of process PID control parameter configuration.

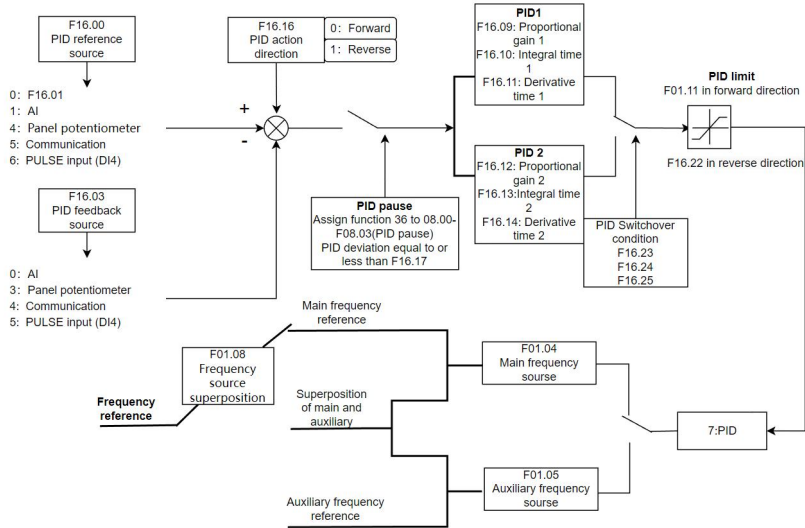

Figure 5-11 Block diagram of process PID control parameter configuration

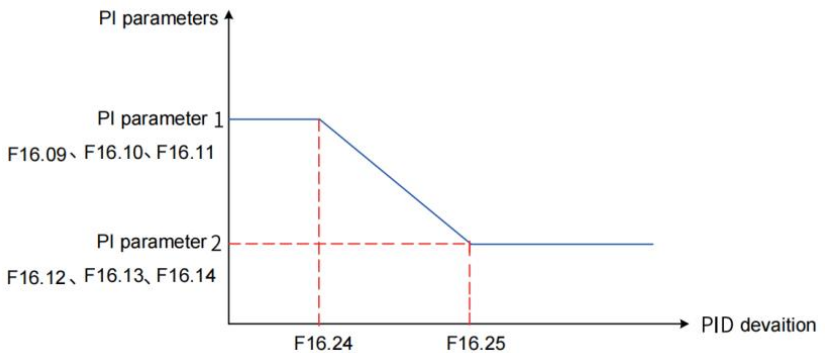

Figure 5-12 PID parameter switchover

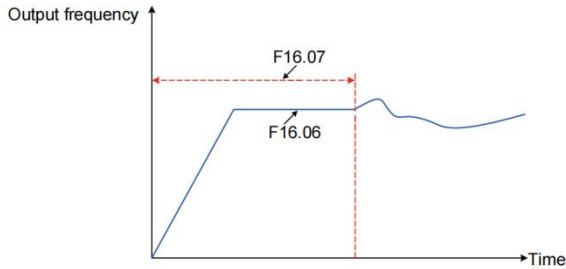

Figure 5-13 PID initial value function

5.2.8 Setting Main Frequency Through Multi-reference

Multi-reference is selected as the main frequency reference source. It is suitable for applications where only several frequency values are required without the need for continuous frequency adjustment.

KC100 supports a maximum of 8 frequency references, which can be set by input signal combinations of three DI terminals. The parameter of multi-reference 0 is set by F17.00, and the parameter of multi-reference 1 to multi-reference 7 is set by F17.01 to F17.07.

In addition to being the main frequency instruction, the multi-reference can also be used as the voltage source for V/F separation and the setting source for process PID.

Application

1. When F01.04 is set to 8, multi-reference is selected as the main frequency reference source.

2. Set the DI terminal function, when using the DI1, DI2, and DI3 as the input terminals of the multi-reference, F08.00, F08.01, F08.02 is set to 21 to 23, corresponding to the multi-reference input terminals 1 ~ 3.

Terminals DI1, DI2, and DI3 are used as multi-reference input terminals. They each contribute one bit to a 3-bit binary value, and different combinations of the bits represent different frequencies. The three multi-reference terminals can provide 8 state combinations, corresponding to 8 frequency reference values. See the following table.

Table 5-15 State combinations of the three multi-reference terminals

K3	K2	K1	Reference	Parameter
OFF	OFF	OFF	Multi-reference 0	Correspond to the channel selected by F17.00
OFF	OFF	ON	Multi-reference 1	F17.01
OFF	ON	OFF	Multi-reference 2	F17.02
OFF	ON	ON	Multi-reference 3	F17.03
ON	OFF	OFF	Multi-reference 4	F17.04
ON	OFF	ON	Multi-reference 5	F17.05
ON	ON	OFF	Multi-reference 6	F17.06
ON	ON	ON	Multi-reference 7	F17.07

5.2.9 Setting the main frequency through simple PLC

The first step is to set parameter F01.04=9 and select simple PLC as the main frequency input command.

The second step is to set parameters F17.19-F17.34, set parameters F01.23-F01.30, and define the running time and acceleration and deceleration time of each speed.

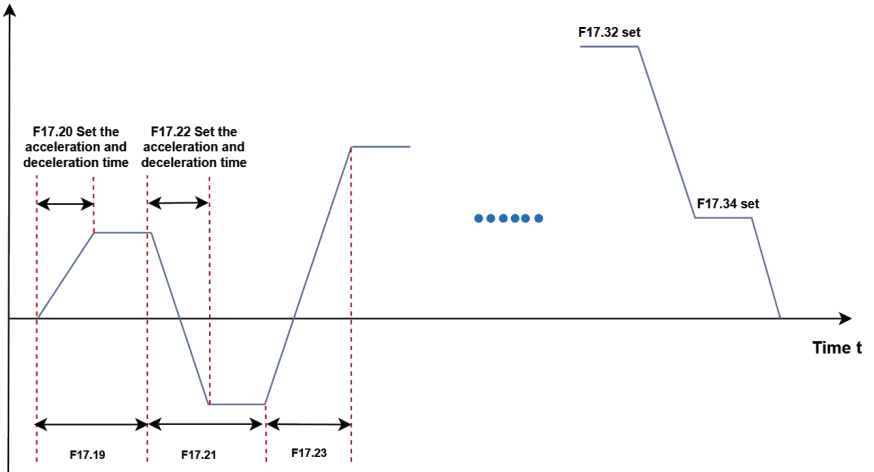

Figure 5-14 Schematic diagram of simple PLC setting master frequency

The third step is to set F17.17, select the simple PLC cycle mode, timing unit and after power failure or shutdown, whether to remember the PLC running stage and operating frequency before power failure and shutdown.

5.2.10 Selecting Source of Auxiliary Frequency Reference

The AC drive supports 8 auxiliary frequency sources, including operating panel digital setting, AI, panel potentiometer, communication, pulse input, PID, multi-reference and simple PLC, which can be selected by setting F01.05 (0 to 9).

When used as an independent frequency reference source, the auxiliary frequency reference source is used in the same way as the main frequency reference source. The figure 5-6 shows the block diagram. When the auxiliary frequency reference is used together with the main frequency reference to set the frequency reference, see "5.2.11 Setting Frequency Based on Main and Auxiliary Frequency References".

Table 5–16 Source of auxiliary frequency reference parameter

Parameter code (address)	Name	Content	Default (Value Range)
F01.05 (0x0105)	Auxiliary frequency source Y	0: Operating panel digital setting(F01.10) 1: AI 4: Panel potentiometer 5: Communication 6: PULSE input(DI4) 7: PID 8: Multi-reference 9: Simple PLC	0 (0~9)

5.2.11 Setting Frequency Based on Main and Auxiliary Frequency References

Main and auxiliary frequency reference superposition is used to set the frequency reference by combining the main frequency reference and auxiliary frequency reference. F01.08 defines the relationship between the target frequency and the main and auxiliary frequency references, which is described as follows.



Table 5–17 Relationship between target frequency and main and auxiliary frequency references

No.	Relationship Between Target Frequency and Main and Auxiliary Frequency References	
1	Main frequency reference	The main frequency reference is directly used as the target frequency.
2	Main and auxiliary operation	There are four main and auxiliary operation results: main frequency reference + auxiliary frequency reference, main frequency reference – auxiliary frequency reference, larger value between main frequency reference and auxiliary frequency reference, and smaller value between main frequency reference and auxiliary frequency reference.
3	Frequency switchover	Any of the preceding three frequency sources selected or switched by using the DI terminal. The DI terminal must be assigned with function 28 to 30(frequency reference switchover).

Table 5–18 Frequency source parameter

Parameter code (address)	Name	Content	Default (Value range)
F01.08 (0x0108)	Frequency source superposition	Ones: Frequency source selection 0: Main frequency source X 1: Main and auxiliary operation result (based on the tens) 2: Switchover between main frequency source X and auxiliary frequency source Y 3: Switchover between main frequency source X and main and auxiliary operation result 4: Switchover between auxiliary frequency source Y and main and auxiliary operation result Tens: Main and auxiliary frequency source operation 0: Main + Auxiliary 1: Main – Auxiliary 2: Max. (main, auxiliary) 3: Min. (main, auxiliary)	0 (0x00~0x34)
F01.06 (0x0106)	Base value of range of auxiliary frequency source Y	0: Relative to the maximum frequency 1: Relative to main frequency X reference	0 (0~1)
F01.07 (0x0107)	Gain of auxiliary frequency source Y	This parameter defines gain of auxiliary frequency source Y.	100.0% (0.0~150.0%)

When the main frequency is set through main and auxiliary frequency reference superposition, the following need to pay attention to.

1. When the auxiliary frequency reference is set to the digital setting, the frequency is corrected by the UP  and DOWN  keys(or DI terminal is assigned with UP, DOWN) on the basis of the main given frequency. In this case, operating panel digital setting(F01.10) are ineffective.

2. When the auxiliary frequency reference is set to analog input(AI or Panel Potentiometer) or PULSE input, 100% the percentage corresponding refers to the range of auxiliary frequency source Y, set by F01.06 and F01.07.

3. The auxiliary frequency sources and the main frequency sources cannot be set to the same channel, that is, do not set F01.04 and F01.05 to the same value; otherwise, confusion may occur.

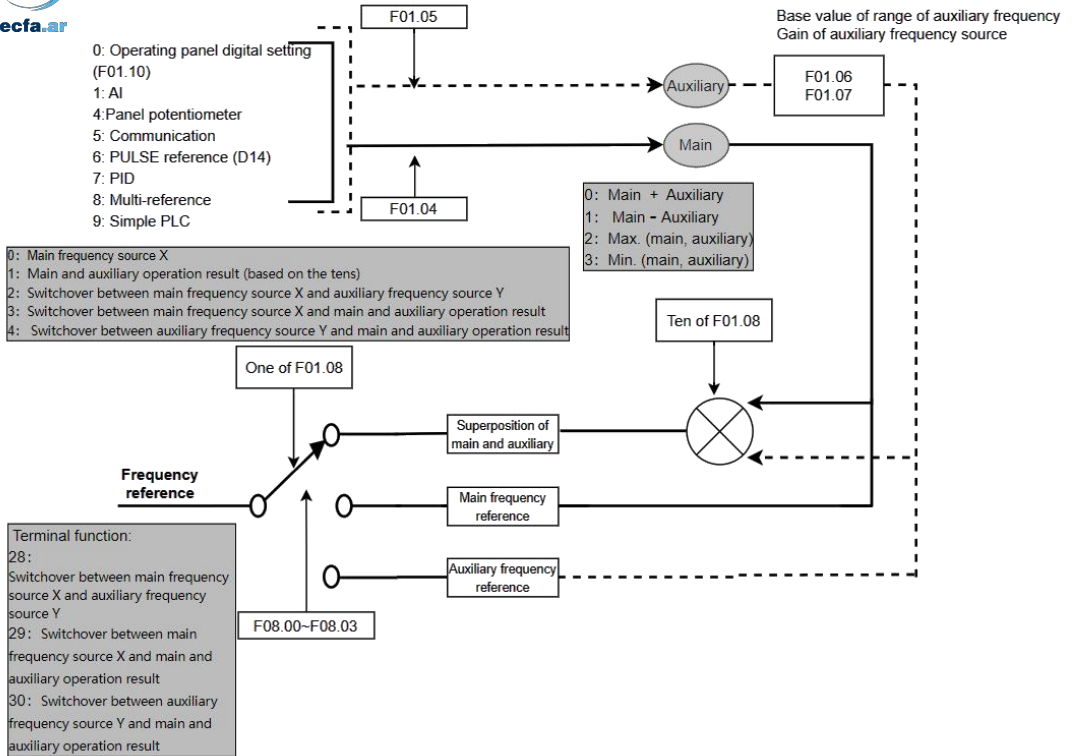

Figure 5-15 Selecting main and auxiliary frequency reference superposition result as frequency reference

5.2.12 Main Frequency Source Bound To The Command Source

F01.09 allows you to set the frequency sources for the three command sources of the AC drive. The operation command sources and the main frequency source can be arbitrarily bundled and switched synchronously. This parameter defines a bundle combination between three operation command sources and seven frequency sources.

When the specified command source (F01.03) is bound to a frequency source (corresponding bit of F01.09), the frequency is determined by the frequency reference source set in F01.09. In this case, F01.04 are ineffective.

As shown in the following figure:

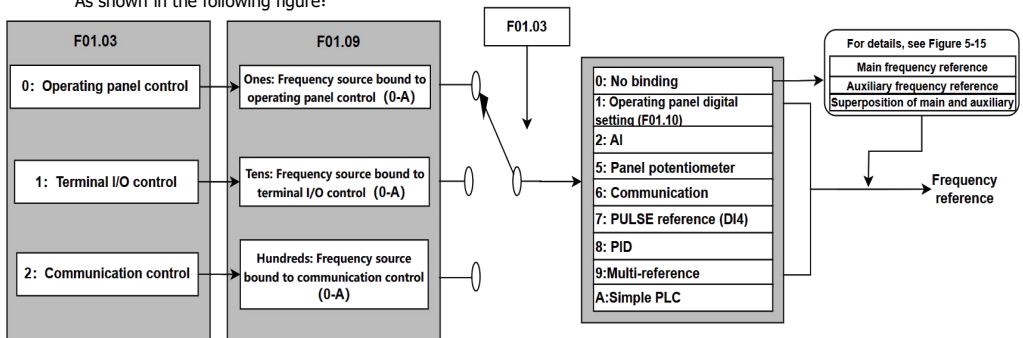

Figure 5-16 Main Frequency Source Bound To The Command Source

Table 5–19 Frequency source bound to the command source parameter

Parameter code (address)	Name	Content	Default (Value Range)
F01.09 (0x0109)	Frequency source bound to the command source	Ones: Frequency source bound to operating panel control Tens: Frequency source bound to terminal I/O control Hundreds: Frequency source bound to communication control 0: No binding 1: Operating panel digital setting(F01.10) 2: AI 5: Panel potentiometer 6: Communication 7: PULSE input(DI4) 8: PID 9: Multi-reference A: Simple PLC	0x000 (0x000~0xAAA)

5.2.13 Setting Action to Take When Frequency Is Below Lower Limit

The frequency lower limit defines the minimum running frequency for the motor.

If the frequency of the AC drive is set to a value below the frequency lower limit (F01.14), you need to set F02.29 to select the action of the AC drive. The actions include the following: run at frequency lower limit, stop in F02.20 mode, and run at zero speed.

0: Run at frequency lower limit

When the running frequency is lower than the frequency lower limit, the AC drive runs at the frequency lower limit.

1: Stop

When the running frequency is lower than the frequency lower limit, the AC drive stops in F02.20 mode.

2: Run at zero speed

When the running frequency is lower than the frequency lower limit, the AC drive runs at zero speed.

Table 5–20 Frequency lower limit setting parameter

Parameter code (address)	Name	Content	Default (Value Range)
F02.29 (0x021D)	Action to take when frequency is below lower limit	0: Run at frequency lower limit 1: Stop in F02.20 mode 2: Run at zero speed	0 (0~2)

5.2.14 Setting Frequency Reference Limits

Maximum frequency: Defines the maximum output frequency.

Frequency upper limit: Limits the maximum operating frequency for motors.

Frequency upper limit source: Defines the reference source of the frequency upper limit.

Related parameter: F01.11~F01.13

5.2.15 Skip Frequency

The skip frequency enables the AC drive to avoid any frequency at which a mechanical resonance may occur. KC100 supports two skip frequencies. If they are all set to 0, the frequency skip function is disabled.

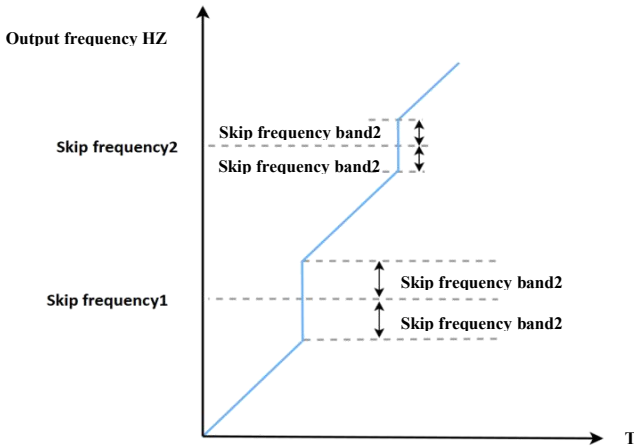

Figure 5-17 Skip frequency

In the figure above, during the acceleration and deceleration process, the operating frequency accelerates to the jump frequency boundary, and the operating frequency of the inverter will skip the jump frequency, and the jump amplitude is 2 times the jump frequency amplitude.

Table 5-21 Skip frequency related parameter

Parameter code (address)	Name	Content	Default (Value Range)	Description
F02.37 (0x0225)	Skip frequency 1	This parameter defines the first skip frequency.	0.00Hz (0.00Hz~F00.11)	The skip frequency enables the AC drive to avoid any frequency at which a mechanical resonance may occur. This parameter defines the skip frequency. If it is set to 0, the skip frequency is canceled.
F02.39 (0x0227)	Skip frequency 2	This parameter defines the second skip frequency.	0.00Hz (0.00Hz~F00.11)	
F02.38 (0x0226)	Skip frequency band 1	This parameter defines the skip frequency band 1.	0.00Hz (0.00Hz~5.00Hz)	During acceleration, when the running frequency increases to a value that is close to the skip frequency, the AC drive operating frequency skips over the skip frequency band. The skip range is twice the value of skip frequency band.
F02.40 (0x0228)	Skip frequency band 2	This parameter defines the skip frequency band 2.	0.00Hz (0.00Hz~5.00Hz)	During deceleration, when the running frequency decreases to a value that is close to the skip frequency, the AC drive operating frequency skips over the skip frequency. The skip range is twice the value of skip frequency band.
F02.36 (0x0224)	Skip frequency enable during acceleration/ deceleration	0: Disabled 1: Enabled	0 (0~1)	This parameter defines whether the skip frequency function is enabled during acceleration/deceleration. 0: During acceleration/deceleration, when the running frequency reaches the skip frequency boundary, the AC drive continues to run at the running frequency. 1: During acceleration/deceleration, when the running frequency reaches the skip frequency boundary, the AC drive skips over the skip frequency. The skip range is twice the value of skip frequency band.

5.3 Jogging

Jogging applies to applications in which the AC drive needs to run at low speed temporarily to facilitate equipment testing. The startup mode is fixed as direct start(F02.00=0), and the stop mode is fixed as decelerate to stop(F02.20=0), during jogging.

The following figure shows the relationship between the output frequency and acceleration/deceleration time during running.

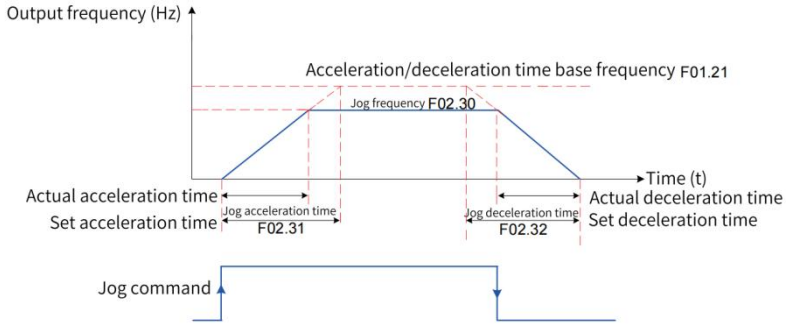

Figure 5-18 Schematic diagram of jogging

Table 5-22 Jogging related parameter

Parameter code (address)	Name	Content	Default (Value Range)
F01.03 (0x0103)	Operation command source	0: Operating panel control 1: Terminal I/O control 2: Communication control	0 (0~2)
F01.21 (0x0115)	Base value of the acceleration/deceleration	0: Relative to the maximum frequency 1: Relative to the setting frequency	0 (0~1)
F15.00 (0x0F00)	M key function	0: M key disabled 1: Switchover between operating panel control and remote control (terminal I/O control or communication control) 2: Switchover between forward and reverse run 3: Forward jogging 4: Reverse jogging	0 (0~4)
F02.30 (0x021E)	Jog frequency	This parameter defines the running frequency of the AC drive in jogging mode.	5.00Hz (0.00Hz~F01.11)
F02.31 (0x021F)	Jog acceleration time	This parameter defines the acceleration time of the AC drive in jogging mode.	10.0s (0.1s~6000.0s)
F02.32 (0x0220)	Jog deceleration time	This parameter defines the deceleration time of the AC drive in jogging mode.	10.0s (0.1s~6000.0s)
F02.28 (0x021C)	Reverse frequency inhibition	0: Disabled 1: Enabled	0 (0~1)
F02.35 (0x0223)	Jog preferred	0: OFF Jog preferred 1: Jog preferred	0 (0~1)

Application:

The following introduces how to set parameters related to jogging by taking implementation of jogging using the operating panel as an example.

Table 5-23 Setting parameters related to jogging

Step	Forward Jogging	Reverse Jogging
1	Set F15.00 to 3 to assign the forward jogging function to the M key.	Set F15.00 to 4 to assign the reverse jogging function to the M key. Set F02.28 (reverse frequency inhibition) to 0 to allow reverse run.
2	Set F01.03 to 0 to select the operating panel as the command source.	Set F01.03 to 0 to select the operating panel as the command source.
3	Set F02.30 (jog frequency), F02.31 (jog acceleration time), and F02.32 (jog deceleration time) properly.	Set F02.30 (jog frequency), F02.31 (jog acceleration time), and F02.32 (jog deceleration time) properly.
4	Press down the M key when the AC drive is in stop state. The AC drive starts to jog in the forward direction. Release the M key. The AC drive decelerates to stop.	Press down the M key when the AC drive is in stop state. The AC drive starts to jog in the forward direction. Release the M key. The AC drive decelerates to stop.

5.4 Start-stop Instruction

5.4.1 Startup Modes

The AC drive supports three startup modes: direct start, pre-excitation start and speed tracking start. You can set F02.00 to select the startup mode of the AC drive.

5.4.1.1 Direct Start

When F02.00 is set to 0, the direct start mode is adopted, which applies to most load applications.

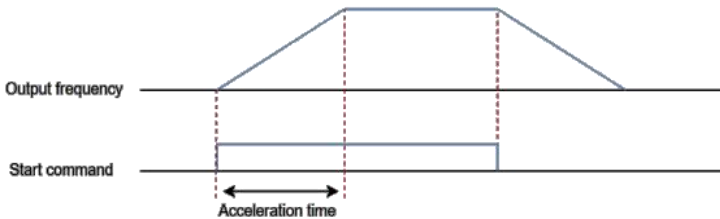

Figure 5-19 Timing diagram of direct start

Startup with startup frequency.

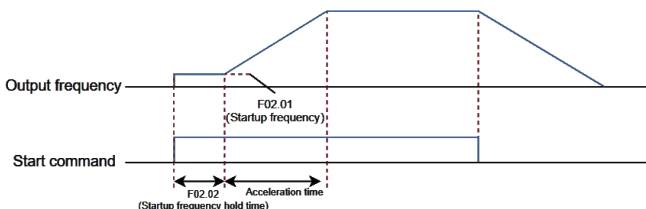

Figure 5-20 Timing diagram of startup with startup frequency

Startup with DC braking is applicable to applications where the motor may rotate at startup.

If the DC braking time is set to 0, the AC drive starts to run at the startup frequency. If the DC braking time is not 0, the AC drive performs DC braking first and then starts to run at the startup frequency. This mode applies to most small-inertia load applications where the motor is likely to rotate at startup.

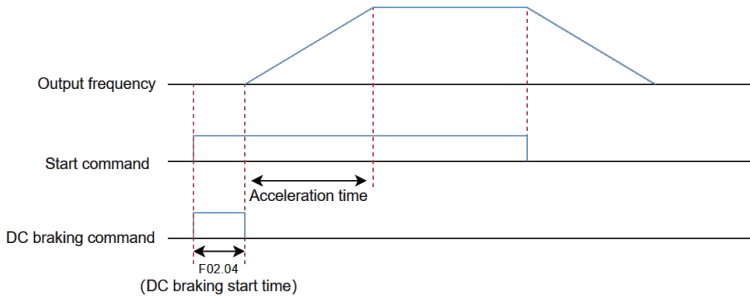

Figure 5-21 Timing diagram of startup with DC braking

The following figure shows the frequency curve during startup:

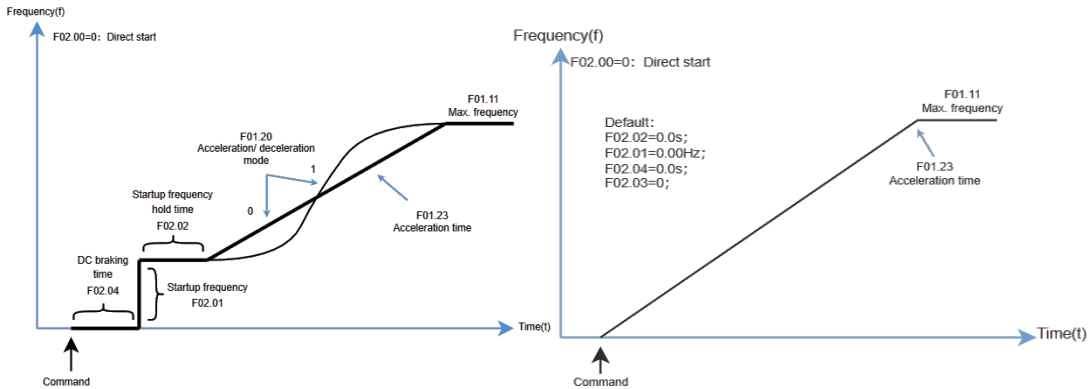

Figure 5-22 Direct start mode

5.4.1.2 Pre-Excitation Start

When F02.00 is set to 1, the AC drive enters the pre-excitation start mode, which is only applicable to the SVC control mode. Pre-excited the motor before starting can improve the fast response characteristics of the motor, reduce the starting current, meet the application requirements requiring a relatively short acceleration time, and the starting sequence is consistent with the DC braking restart.

5.4.1.3 Speed tracking start

Set the parameter F02.00=2, the AC drive speed tracking start, suitable for restarting the rotating motor, can avoid the occurrence of over current.

5.4.2 Stop Modes

The AC drive supports two stop modes: decelerate to stop and coast to stop. You can set F02.20 to select a stop mode as required.

5.4.2.1 Decelerate To Stop

Set parameter F02.20=0 to slow down and stop the frequency converter. At this point, after the shutdown command is effective, the frequency converter will reduce the output frequency according to the deceleration time. After the frequency drops to 0, the frequency converter will stop outputting.

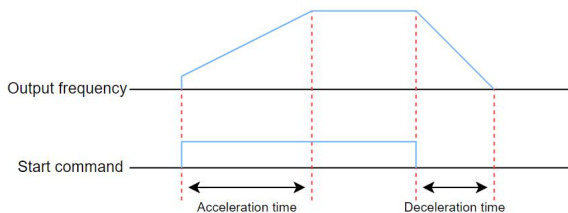

Figure 5-23 Deceleration parking sequence diagram

By setting parameters F02.23 to F02.26, select whether to use the DC braking function at the end of the shutdown period.

Table 5-24 Shutdown Setting Parameters Table

Parameter code (Address)	Name	Content	Factory value (Setting range)
F02.23 (0x0217)	Start frequency of DC braking at stop	The AC drive starts DC braking when the running frequency decreases to the value of this parameter during deceleration to stop	0.00Hz (0.00Hz~F01.11)
F02.24 (0x0218)	DC braking delay at stop	When the running frequency decreases to the start frequency of DC braking at stop, the AC drive stops output and starts DC braking after this waiting time.	0.0s (0.0s~100.0s)
F02.25 (0x0219)	DC braking current at stop	This parameter defines the stopping DC braking current, a larger DC braking current indicates stronger braking force	0% (0%~150%)
F02.26 (0x021A)	Stop DC braking time	This parameter defines the shutdown DC brake hold time	0.0s (0.0s~100.0s)

After the operating frequency is reduced to the setting value of F02.23(stop DC braking initial frequency), the inverter stops output for a period of time according to the setting value of F02.24(stop DC braking waiting time), and then starts the DC braking process after the waiting time reaches. This function can be used to prevent over-current failures that may occur when DC braking starts at higher speeds.

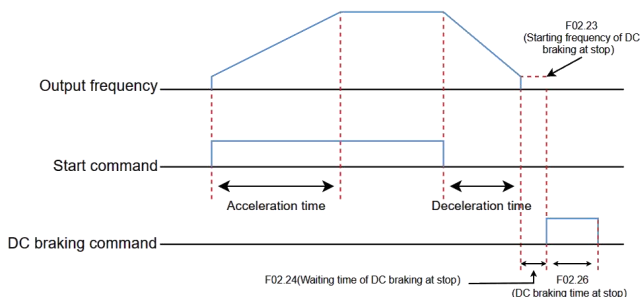

Figure 5-24 Timing diagram of DC braking at stop

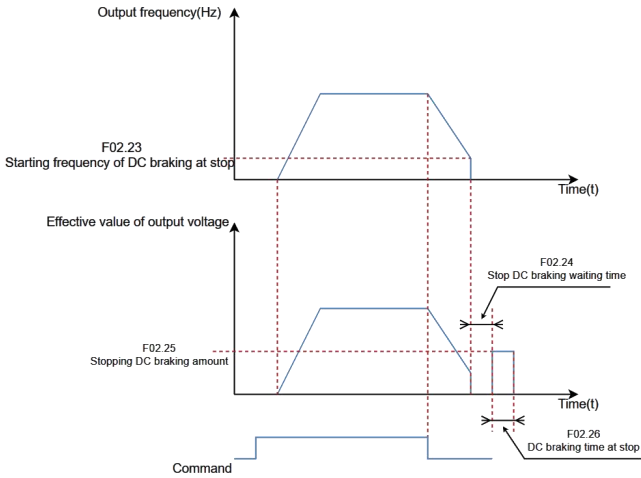

Figure 5-25 DC braking process in stop

5.4.2.2 Coast To Stop

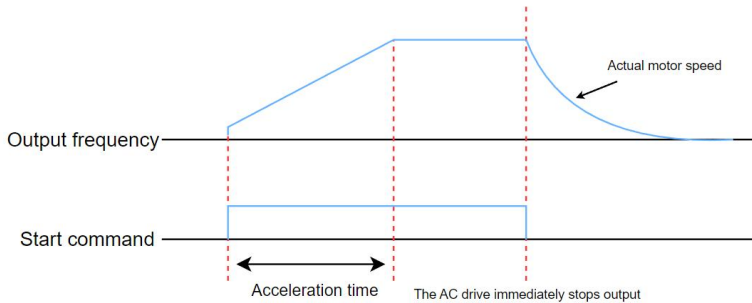

Figure 5-26 Timing diagram of coasting to stop

5.4.3 Acceleration and Deceleration Time Setting

The acceleration time indicates the time required for the output frequency of the AC drive to rise from 0 to the acceleration/deceleration base frequency (F01.21). The deceleration time indicates the time required for the output frequency of the AC drive to decrease from the acceleration/deceleration base frequency (F01.21) to 0 Hz.

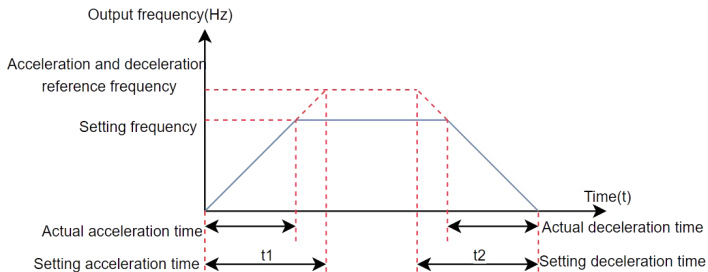

Figure 5-27 Acceleration/Deceleration time

The AC drive provides totally four groups of acceleration/deceleration time, which can be selected by using a DI terminal (assigned with function 32/33). The acceleration/deceleration time is defined by the following parameters:

Table 5-25 Acceleration and deceleration time setting parameters table

Parameter code (Address)	Name	Content	Factory value (Setting range)
F01.23 (0x0117)	Acceleration time 1	Acceleration time 1 of output frequency from 0.00Hz to F01.21	10.0s (0.0s~6000.0s)
F01.24 (0x0118)	Deceleration time 1	Deceleration time 1 of output frequency from F01.21 to 0.00Hz	
F01.25 (0x0119)	Acceleration time 2	Acceleration time 2 of output frequency from 0.00Hz to F01.21	
F01.26 (0x011A)	Deceleration Time 2	Deceleration time 2 of output frequency from F01.21 to 0.00Hz	
F01.27 (0x011B)	Acceleration time 3	Acceleration time 3 of output frequency from 0.00Hz to F01.21	
F01.28 (0x011C)	Deceleration Time 3	Deceleration time 3 of output frequency from F01.21 to 0.00Hz	
F01.29 (0x011D)	Acceleration time 4	Acceleration time 4 of output frequency from 0.00Hz to F01.21	
F01.30 (0x011E)	Deceleration Time 4	Deceleration time 4 of output frequency from F01.21 to 0.00Hz	

The AC drive can also automatically switch the acceleration and deceleration time based on the switching frequency. At this time, the DI terminal function cannot be set to the 32 (acceleration/deceleration time switching terminal 1) and 33 (acceleration/deceleration time switching terminal 2) functions.

During the acceleration process, if the operating frequency is less than F01.35, select acceleration time 2; If the operating frequency is greater than F01.35, select acceleration time 1. During the deceleration process, if the operating frequency is greater than F01.36, select deceleration time 1. If the operating frequency is less than F01.36, select deceleration time 2.

Table 5-26 Acceleration and deceleration time switching parameters table

Parameter code (Address)	Name	Content	Factory value (Setting range)
F01.35 (0x0123)	Switching frequency between acceleration time 1 and acceleration time 2	This parameter defines the switching frequency between acceleration time 1 and acceleration time 2	0.00Hz (0.00Hz~F01.11)
F01.36 (0x0124)	Switching frequency between deceleration time 1 and deceleration time 2	This parameter defines the switching frequency between deceleration time 1 with deceleration time 2	0.00Hz (0.00Hz~F01.11)

The schematic diagram of acceleration and deceleration time switching is shown in the following figure:

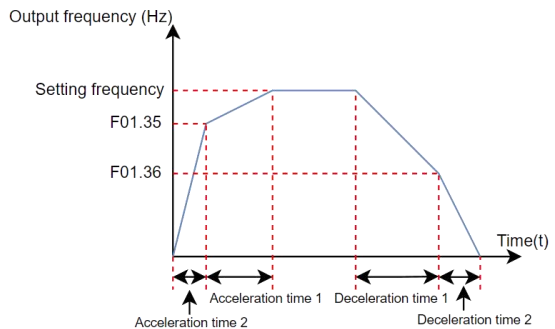

Figure 5-28 Schematic diagram of acceleration and deceleration time switching

5.5 Control Terminals

5.5.1 DI

The KC100 comes standard with four multifunctional digital input terminals (DI4 can be used as a high-speed pulse input terminal).

You can define the DI terminal input functions by setting the values of parameters F08.00 to F08.03 .

At the same time, you can also set the effective characteristics of the DI terminal, filtering time and delay time.

For details about how to set the high-speed PULSE input terminal, see 5.2.6 Setting the Main Frequency Using Pulse Pulse.

Related parameters: F08 group.

5.5.2 AI

The KC100 comes with one AI terminal as standard

Table 5-27 Description of analog (AI) terminals

Terminal	Name	Type	Input range	Impedance
AI-GND	Control board AI terminal 1	Voltage mode ⁽¹⁾	0V~10VDC	20kΩ
		Current mode ⁽¹⁾	0mA~20mA	500Ω

[1] The AI-U and AI-I in dip switch SW1 can select whether the AI input is voltage type or current type. The AI-U and AI-I can only choose one. If the DIP switch is set to ON, it is valid. If the DIP switch is set to OFF, it is invalid.

In addition, the KC100 control board comes standard with a panel potentiometer.

For details about how to set the AI curve, see 5.2.4 Setting the Master Frequency by Analog (AI or Panel Potentiometer).

Related parameters: F09 group.

5.5.3 DO

KC100 comes standard with 1 multi-functional digital output terminal (DO) and 1 multi-functional relay output terminal (TA/TB/TC). Among them, DO is a transistor type output that can drive a 24V DC low-voltage signal circuit; TA/TB/TC is a relay output that can drive a 250V AC control circuit.

Table 5-28 List of Digital Output Terminals (DO)

Port name	Corresponding parameters	Output characteristic description
DO-COM	When F10.05=0, F10.01	Transistors; Driving capacity: 24VDC, 50mA
	When F10.05=1, F11.02	Transistors; Can output high-frequency pulses ranging from 0.1kHz to 50kHz; Driving capacity: 24VDC, 50mA
TA-TB-TC	F10.02	Relay; Driving capacity: 250VAC, 3A

By setting the values of parameters F10.01 and F10.02, various digital output functions can be defined to indicate various working states and alarms of the frequency converter. For specific functions, please refer to "7.22 Terminal Output Function Selection".

Related parameters: F10 group.

5.5.4 AO

KC100 comes standard with one analog output terminal AO. Select whether the AO output is voltage type or current type through the AO-U and AO-I switches in SW1. AI-U and AI-I can only choose one from the other. Setting the dial switch to ON is valid, while OFF is invalid.

AO can be used to indicate internal operating parameters in analog mode, and the indicated parameter attributes can

be selected through parameter F11.00.

The AO output curve can correct the zero drift and output amplitude deviation of the analog output, as shown in the following figure. If the zero offset is represented by "b", the gain is represented by k, the actual output is represented by Y, and the standard output is represented by X, then the actual output is: $Y=kX+b$.

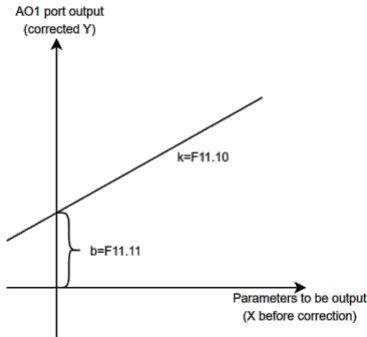

Figure 5-29 AO Signal Correction Characteristic Curve

Among them, the zero deviation coefficient of AO is 100% corresponding to 10V (or 20mA), and zero deviation=zero deviation coefficient × 10V (or 20mA). Standard output refers to the quantity represented by the analog output corresponding to 0V~10V (or 0mA~20mA) without zero bias and gain correction.

Related parameters: F11 group.

5.6 Motor Configuration

5.6.1 Motor Control Mode Selection

The motor control mode is set through parameter F01.02. Set to 0, select V/F control (speed open loop control); Set to 1, select Speed Sensorless Vector Control (SVC);

Speed Sensorless Vector Control (SVC): Refers to open-loop vector control, suitable for high-performance control situations where one AC drive can only drive one motor. Load such as machine tools, centrifuges, wire drawing machines, injection molding machines, etc;

V/F control (speed open loop control): suitable for situations where load requirements are not high or where one AC drive drives multiple motors, such as fan and pump loads. It can be used in situations where one frequency converter drives multiple motors.

5.6.2 Motor Parameter Self-learning

The process of obtaining the internal electrical parameters of the controlled motor from the AC drive is called self-learning. The methods of self-learning include: static self-learning of asynchronous motors (partial parameters), rotating self-learning of asynchronous motors (all parameters), manual input of motor parameters, and other methods. The static self-learning and rotating self-learning methods of asynchronous motors are set through parameter F03.09.

The adaptability and tuning effects of several debugging methods are shown in the table below.

Table 5-29 Debugging Methods

Tuning mode	Applicable situation	Tuning effect
No-load asynchronous motor rotation self-learning (all parameters) F03.09 = 2	Where the motor is easily separated from the application system	best
Static self-learning of asynchronous motor F03.09 = 1	Where the motor is difficult to separate from the load and does not allow dynamic tuning operation.	normal

Manual input parameter	When the motor is difficult to separate from the application system, the parameters of the same type of motor that has been successfully tuned by the AC drive are copied and input to the corresponding parameters of F03.10 ~ F03.14	preferably
------------------------	--	------------

Application :

The steps for automatic tuning of motor parameters are as follows:

- 1.If the motor can be completely disconnected from the load, in the event of a power outage, mechanically separate the motor from the load to allow the motor to rotate freely without load;
- 2.After powering on, first select the frequency converter command command (F01.03) as the operation panel command channel;
3. Accurately input the nameplate parameters of the motor (such as F03.02~F03.06), please input the following parameters according to the actual motor parameters (based on the current motor selection).

Table 5-30 Table of Motor Parameters Required for Self Learning

Parameter code (address)	Name
F03.02 (0x0302)	Rated motor power
F03.03 (0x0303)	Rated motor voltage
F03.04 (0x0304)	Rated motor current
F03.05 (0x0305)	Rated motor frequency
F03.06 (0x0306)	Rated motor speed

4. F03.09 (tuning selection) select 2 and press the ENTER key to confirm. At this time, the keyboard displays EST · 00, as shown in the following figure:



Figure 5-30 Self learning mode operation panel

5. Press the RUN key on the keyboard, and the frequency converter will learn the motor parameters from F03.10 to F03.14. The RUN indicator light will remain on ●, and the ALM light will flash ●. The tuning operation will last for about 2 minutes. When the above display information disappears, it will return to the normal parameter display state, indicating that the tuning is completed.

After this complete tuning, the frequency converter will automatically calculate the following parameters of the motor.

Table 5-31 Table of Motor Parameters Calculated by Self Learning

Parameter code (address)	Name
F03.10 (0x030A)	Asynchronous motor stator resistance
F03.11 (0x030B)	Asynchronous motor rotor resistance
F03.12 (0x030C)	Asynchronous motor leakage inductance

F03.13 (0x030D)	Asynchronous motor mutual inductance
F03.14 (0x030E)	Asynchronous motor no-load current

5.7 Control Performance

5.7.1 Speed Loop and Torque Limit

5.7.1.1 Speed Loop

The PI parameters of the speed loop are divided into two groups: low speed and high speed. When the operating frequency is less than F06.04 (switching frequency 1), the PI adjustment parameters of the speed loop are F06.00 (proportional gain of the low speed loop) and F06.01 (integration time of the low speed loop). When the operating frequency is greater than F06.05 (switching frequency 2), the speed loop PI adjustment parameters are F06.02 (high-speed speed loop proportional gain) and F06.03 (high-speed speed loop integration time). The PI parameters of the speed loop between switching frequency 1 and switching frequency 2 are linearly switched between two sets of PI parameters, as shown in the following figure.

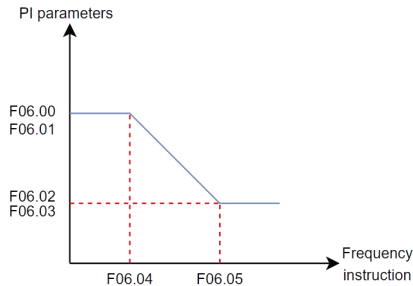

Figure 5-31 Speed loop PI parameters

By setting the proportional gain and integral time of the speed regulator, you can adjust the dynamic response to speed changes in vector control. Increasing the proportional gain or reducing the integral time can speed up dynamic response of the speed loop. However, excessively large proportional gain or excessively short integral time may cause system oscillation.

In this case, if the parameters obtained by auto-tuning cannot meet the requirements, make fine adjustments based on the parameter values. Increase the proportional gain first to ensure that the system does not oscillate, and then reduce the integral time to ensure that the system has quick response and small overshoot.

Table 5-32 Speed Loop PI Related Parameters Table

Parameter code (address)	Name	Content	Factory value (Setting range)
F06.00 (0x0600)	Low speed loop proportional gain	This parameter defines the low speed loop proportional gain	60 (1~500)
F06.01 (0x0601)	Low speed loop integration time	This parameter defines low speed loop integration time	0.20s (0.01s~5.00s)
F06.02 (0x0602)	High speed loop proportional gain	This parameter defines the high speed loop proportional gain	30 (1~500)
F06.03 (0x0603)	High speed loop integration time	This parameter defines the high speed loop integration time	0.50s (0.01s~5.00s)
F06.04 (0x0604)	Switchover frequency 1	This parameter defines the switchover frequency 1 of the speed loop	5.00Hz (0.00Hz~F06.05)
F06.05 (0x0605)	Switchover frequency 2	This parameter defines the switchover frequency 2 of the speed loop	10.00Hz (F06.04~F01.11)

Explanation:

Improper setting of PI parameters may lead to excessive speed overshoot. Even over-voltage faults occur when overshoot falls back.

5.7.1.2 Speed Control Torque Upper Limit

There is a control method under vector control (SVC): speed control.

In speed control mode, there are 5 settings for the torque upper limit source. In the electric state, the torque upper limit source is selected by F06.11, and in the power generation state, the torque upper limit source is selected by F06.13. If F06.11 is set to 1-6, the torque upper limit distinguishes between the electric state and the power generation state. The full range of the electric state torque upper limit is set by F06.12 (the torque upper limit in the electric state is based on the rated current of the frequency converter), and the full range of the power generation state torque upper limit is set by F06.14, as shown in the following figure.

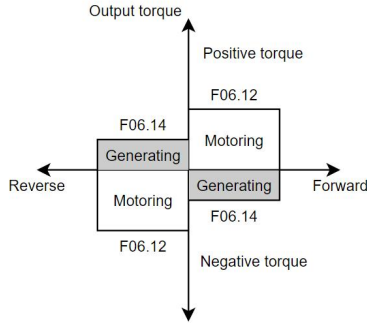

Figure 5-32 Schematic diagram of speed control torque upper limit

You can also set F06.10=1 torque limit to lock the F06.11 setting channel.

Table 5-33 Speed control torque related parameters table

Parameter code (address)	Name	Content	Factory value (Setting range)
F06.10 (0x060A)	Torque Lock Selection under Speed Control	0: No lock 1: Motor generation torque is locked to the F06.11 setting channel	0 (0~1)
F06.11 (0x060B)	Torque upper limit source in speed control mode (motoring)	0: Digital setting (F06.12) 1: AI 4: Operating panel potentiometer 5: Communication 6: Pulse-reference (DI4)	0 (0~6)
F06.12 (0x060C)	Torque upper limit in speed control mode (motoring)	This parameter defines torque limit in Speed control mode (electric)	180.0% (0.0%~300.0%)
F06.13 (0x060D)	Torque upper limit source in speed control mode (generating)	0: Digital setting (F06.14) 1: AI 4: Operating panel potentiometer 5: Communication 6: Pulse-reference (DI4)	0 (0~6)
F06.14 (0x060E)	Torque upper limit in speed control mode (generating)	This parameter defines torque limit in speed control mode (generation)	180.0% (0.0%~300.0%)

5.7.1.3 Vector Control Slip Gain

In SVC control mode, the stability accuracy of the motor is improved by adjusting the F06.06 vector control slip compensation gain. For example, when the motor operating frequency is lower than the output frequency of the frequency converter, the vector control slip compensation gain can be increased.

5.7.2 Current Loop

The PI adjustment parameters of the vector control current loop are divided into two groups: excitation and torque. This parameter is automatically obtained after the asynchronous machine is fully tuned and generally does not need to be modified.

If the PI gain of the current loop is set too high, it may cause the entire control loop to oscillate. When the current oscillation or torque fluctuation is large, the PI proportional gain or integral gain can be manually reduced here.

Table 5-34 Current Loop Related Parameters Table

Parameter code (address)	Name	Content	Factory value (Setting range)
F07.00 (0x0700)	Current loop excitation shaft proportional gain	This parameter defines the current loop excitation shaft proportional gain	2000 (0~60000)
F07.01 (0x0701)	Current loop excitation shaft integral gain	This parameter defines the current loop excitation shaft integral gain	1000 (0~60000)
F07.02 (0x0702)	Current loop torque shaft proportional gain	This parameter defines the current loop torque shaft proportional gain	2000 (0~60000)
F07.03 (0x0703)	Current loop torque shaft integral gain	This parameter defines the current loop torque shaft integral gain	1000 (0~60000)

5.7.3 Over-current Control

During acceleration, constant speed, and deceleration, if the current exceeds the over-current stall action current, the over-current control function will suppress excessive current. When the current exceeds the over-current stall action current, reduce the output frequency until the current returns below the over-current stall point. The frequency begins to accelerate to the target frequency, and the acceleration time automatically lengthens. If the actual acceleration time cannot meet the requirements, the over-current stall action current can be appropriately increased.

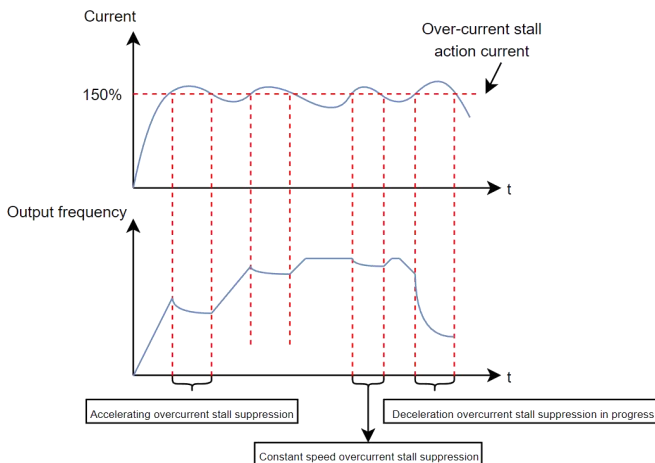

Figure 5-33 Schematic diagram of over-current stall action

At the same time, KC100 defaults to the wave by wave current limiting (F13.04) function. For applications where uneven load leads to an instantaneous increase in load or when the contactor connecting the frequency converter and the motor is momentarily disconnected and then reconnected, the current spikes can be effectively suppressed through wave by wave current limiting.

Table 5-35 Over-current stall related parameters table

Parameter code (address)	Name	Content	Factory value (Setting range)
F13.00 (0x0D00)	Overcurrent stall suppression	0: Disabled 1: Enabled	1 (0~1)
F13.01 (0x0D01)	Overcurrent stall suppression action current	This parameter defines the percentage of overcurrent stall suppression action current threshold	150.0% (50%~200%)
F13.02 (0x0D02)	Overcurrent stall suppression gain	This parameter defines the gain of overcurrent stall suppression response	50 (0~100)
F13.03 (0x0D03)	Compensation coefficient of speed multiplying overcurrent stall suppression action current	Reduce the high-speed overcurrent stall suppression action current threshold	50 (50~200)
F13.04 (0x0D04)	Current protection Settings	Pulse-by-pulse current limit protection 0: Disabled 1: Enabled	1 (0~1)

5.7.4 Over-voltage Control

When the bus voltage reaches the set value of over-voltage stall action voltage, the actual motor speed is greater than the motor speed corresponding to the output frequency of the frequency converter, and the motor is in the power generation state. In order to protect system safety and avoid tripping protection, the frequency converter activates the over-voltage stall protection function and increases the output frequency. The actual deceleration time will automatically extend. If the actual deceleration time cannot meet the system requirements, the over-excitation gain can be appropriately increased.

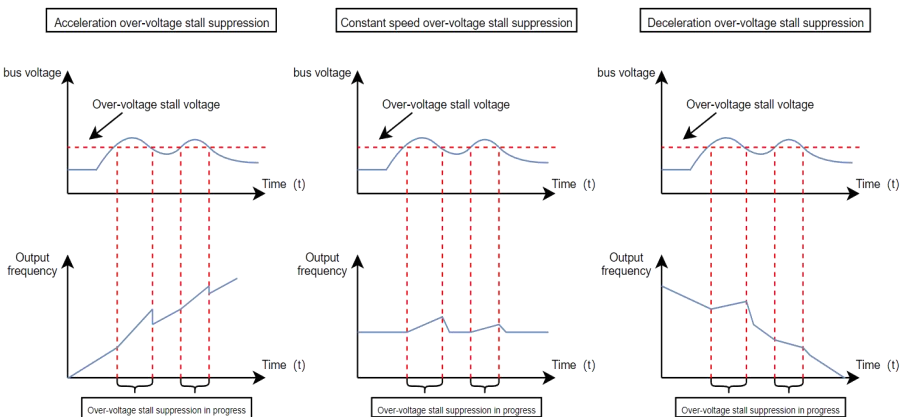

Figure 5-34 Schematic diagram of over-voltage stall action

Table 5-36 over-voltage stall related parameters table

Parameter code (address)	Name	Content	Factory value (Setting range)
F05.14 (0x050E)	Over-excitation gain	This parameter defines the over-excitation gain, the larger the gain, the stronger the suppression effect	100 (0~200)
F05.16 (0x0510)	Oscillation suppression gain	By adjusting this value, low frequency resonance can be suppressed, but it can't be too large, otherwise it will cause additional stability problems	40 (0~200)
F13.10 (0x0D0A)	Overvoltage stall suppression	0: Disabled 1: Enabled	1 (0~1)
F13.11 (0x0D0B)	Overvoltage stall suppression action voltage	This parameter defines the V/f overvoltage stall suppression action voltage threshold	220Vmodel: 380.0V 380Vmodel: 750.0V 440Vmodel: 770.0V (200.0V~820.0V)
F13.12 (0x0D0C)	Overvoltage stall suppression frequency gain	Increase this value will improve the control effect of the bus voltage, but the output frequency will fluctuate	50 (0~100)
F13.13 (0x0D0D)	Overvoltage stall suppresses voltage gain	Suppress the bus voltage and increase this setting value can reduce the bus voltage overshoot	50 (0~100)
F13.14 (0x0D0E)	Frequency rise threshold for overvoltage stall suppression	Overvoltage stall suppression may increase the operating frequency. This parameter is the incremental upper limit of the operating frequency	5.00Hz (0~50.00Hz)
F13.17 (0x0D11)	Start voltage for actuating braking unit	The start voltage for actuating braking unit, used to adjust the brake resistance energy consumption efficiency	220Vmodel: 360.0V 380Vmodel: 700.0V 440Vmodel: 750.0V (200.0V~820.0V)

When using a braking resistor, installing a braking unit, or using an energy feedback unit, please note:

- Please set the F05.14 "over-excitation gain" value to "0", otherwise it may cause excessive current during operation.
- Please set the F13.10 "over-voltage stall enable" value to "0", otherwise it may cause the problem of prolonged deceleration time.

5.7.5 Under Voltage Control (Instant Stop Without Stopping)

The instant stop function allows the system to continue to operate during a short power outage. When the system has a power outage, the inverter makes the motor in the state of power generation, so that the bus voltage is maintained at the "instantaneous stop and non-stop operation judgment voltage", to prevent the inverter from stopping due to the input voltage is too low, resulting in under-voltage failure, as shown in the following figure.

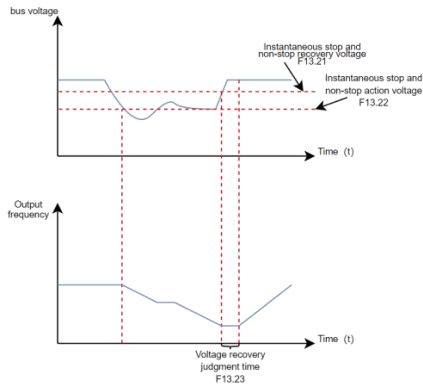

Figure 5-35 Schematic diagram of the instantaneous stop process

When the "bus voltage constant control" mode is used, when the power grid resumes power supply, the output frequency of the frequency converter will recover to the target frequency according to the acceleration time.

When in the "deceleration shutdown" mode, when the power grid resumes power supply, the frequency converter continues to decelerate to 0Hz and stops until the frequency converter issues a start command again before starting the frequency converter.

Table 5-37 List of parameters related to instant stop and non-stop

Parameter code (address)	Name	Content	Factory value (Setting range)
F13.20 (0x0D14)	Power dip ride-through	This parameter defines whether the AC driver runs during instantaneous power failure 0: Disabled 1: Keep bus voltage constant 2: Decelerate to stop	0 (0~2)
F13.21 (0x0D15)	Voltage threshold for disabling power dip ride-through	This parameter defines the voltage threshold for disabling power dip ride-through of the AC driver, if voltage higher than this value, temporarily stop the adjustment	85.0% (80.0%~100.0%)
F13.22 (0x0D16)	Voltage threshold for enabling power dip ride-through	This parameter defines the voltage level at which the bus voltage is maintained upon power failure. Upon power failure, the bus voltage is maintained around F13.22 (voltage threshold for enabling power dip ride-through)	80.0% (60.0%~100.0%)
F13.23 (0x0D17)	Delay of voltage recovery from power dip	This parameter defines the time required for the bus voltage to rise from F13.21 (voltage threshold for disabling power dip ride-through) to the voltage before power failure	0.5s (0.0s~100.0s)
F13.24 (0x0D18)	Power dip ride-through gain Kp	This parameter is valid only in the "keep bus voltage constant" mode (F13.20 = 1). If undervoltage occurs frequently during power dip ride-through, increase the power dip ride-through gain and integral coefficient	50 (0~100)
F13.25 (0x0D19)	Power dip ride-through integral coefficient		30 (0~100)

<p>F13.26 (0x0D1A)</p>	<p>Deceleration time of power dip ride-through</p>	<p>This parameter is valid only in the "decelerate to stop" mode (F13.20 = 2). When the bus voltage is lower than the value of F13.22, the AC drive decelerates to stop. The deceleration time is determined by this parameter but not F01.24</p>	<p>20.0s (0.0s~300.0s)</p>
----------------------------	--	---	--------------------------------

5.8 Introduction to Application Functions

5.8.1 Frequency Detection

5.8.1.1 Frequency Detection (FDT)

Used to set the detection value of the output frequency and the hysteresis value of the output action release. The hysteresis value is only effective during deceleration, and the detection during acceleration does not lag. The frequency detection function is shown in the following figure.

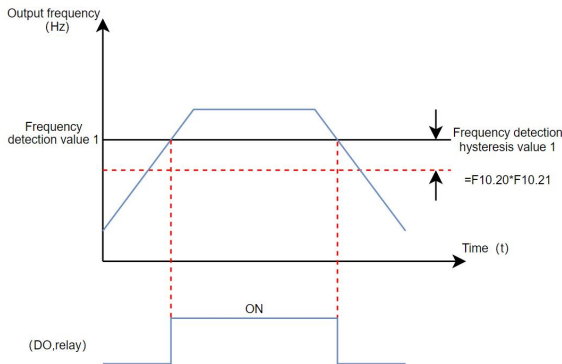

Figure 5-36 Schematic diagram of frequency detection

Table 5-38 Frequency detection related parameters table

Parameter code (address)	Name	Factory value (Setting range)	Description
F10.01 (0x0A01)	DO terminal function	2 (0~35)	15: Frequency level detection FDT1 output 16: Frequency level detection FDT2 output
F10.02 (0x0A02)	RELAY function	8 (0~35)	
F10.20 (0x0A14)	Frequency detection value (FDT1)	5.00Hz (0.00Hz~F01.11)	When the operating frequency is higher than the frequency detection value (FDT1), the DO terminal outputs an effective signal; When the operating frequency is lower than the frequency detection value (FDT1) minus the frequency check lag value (FDT1), the DO terminal outputs an invalid signal. The set value is valid between 0.00Hz and F01.11 (maximum frequency).

F10.21 (0x0A15)	Frequency Detection hysteresis (FDT1)	0.0% (0.0%~100.0%)	The frequency detection lag value (FDT1) is F10.20 times F10.21. When the operating frequency is higher than F10.20, the DO terminal outputs an effective signal; When the operating frequency is below a specific value (F10.20 minus the product of F10.20 and F10.21), the DO terminal outputs an invalid signal.
F10.22 (0x0A16)	Frequency detection value (FDT2)	5.00Hz (0.00Hz~F01.11)	When the operating frequency is higher than the frequency detection value (FDT2), the DO terminal outputs an effective signal; When the operating frequency is lower than the frequency detection value (FDT2) minus the frequency detection delay value (FDT2), the DO terminal outputs an invalid signal. The set value is valid between 0.00Hz and F01.11(maximum frequency).
F10.23 (0x0A17)	Frequency Detection hysteresis (FDT2)	0.0% (0.0%~100.0%)	The frequency detection lag value (FDT2) is F10.22 times F10.23. When the operating frequency is higher than F10.22, the DO terminal outputs an effective signal; When the operating frequency is below a specific value (F10.22 minus the product of F10.22 and F10.23), the DO terminal outputs an invalid signal.

5.8.1.2 Frequency Reaches Detection Amplitude

Set the detection range of frequency arrival through parameter F10.24, and the timing chart of frequency arrival detection amplitude is shown in the following figure.

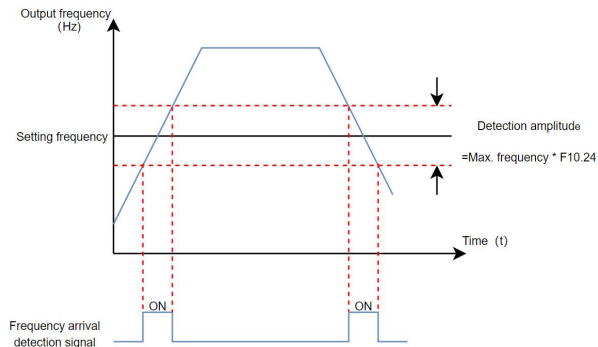

Figure 5-37 Time sequence diagram of frequency reaching detection amplitude

Table 5-39 Frequency Arrival Related Parameters Table

Parameter code (address)	Name	Factory value (Setting range)	Parameter Description
F10.01 (0x0A01)	DO terminal function	2 (0~35)	17: Frequency reaches output
F10.02 (0x0A02)	RELAY function	8 (0~35)	
F10.24 (0x0A18)	Frequency reach detection range	0.0% (0.0%~100.0%)	The detection amplitude value of frequency arrival is the product of F10.24 (frequency arrival detection amplitude) and F01.11 (maximum frequency). When the operating frequency of the AC drive is within a specific range (set frequency \pm F10.24 * F01.11), the DO terminal outputs a valid signal.

5.8.1.3 Any Arrival Frequency Detection Value

When the operating frequency of the AC drive is within the range of any arrival frequency check value \pm any arrival frequency detection amplitude, the DO terminal outputs a valid signal.

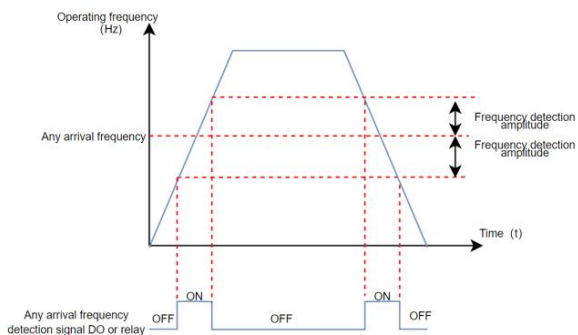
Figure 5-38 Schematic diagram of any arrival frequency detection
Table 5-40 Arrival Frequency Detection Related Parameters Table

Parameter code (address)	Name	Factory value (Setting range)	Parameter Description
F10.01 (0x0A01)	DO terminal function	2 (0~35)	22: Any frequency reaches the output
F10.02 (0x0A02)	RELAY function	8 (0~35)	
F10.25 (0x0A19)	Any frequency reach detection value	50.00Hz (0.00Hz~F01.11)	When the operating frequency of the AC drive is within the frequency detection range, the DO terminal outputs a valid signal. This setting is valid between 0.00Hz and F01.11 (maximum frequency).
F10.26 (0x0A1A)	Any frequency reach detection range	0.0% (0.0%~100.0%)	Frequency arrival detection amplitude 1 is F01.11 (maximum frequency) multiplied by F10.26, and the frequency detection range is F10.25 (frequency arrival detection value) plus or minus F10.26 (frequency arrival detection amplitude), that is: $(F10.25) \pm (F10.26) \times (F01.11)$

5.8.2 Current Detection

5.8.2.1 Zero-current Detection

When the output current of the AC drive is less than or equal to the zero-current detection level (F10.29) and the duration exceeds the zero-current detection delay time (F10.30), the DO terminal outputs a valid signal.

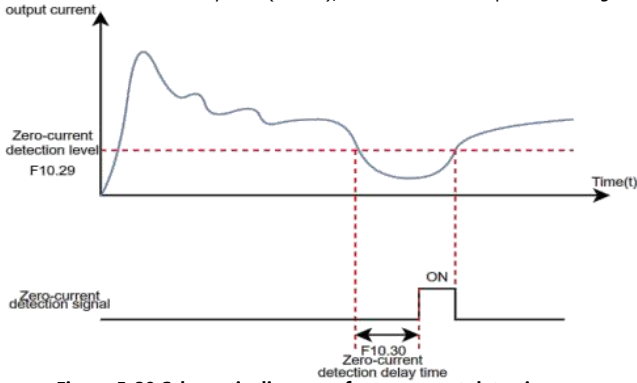

Figure 5-39 Schematic diagram of zero-current detection

Table 5-41 Zero-Current Detection Related Parameters Table

Parameter code (address)	Name	Factory value (Setting range)	Parameter Description
F10.01 (0x0A01)	DO terminal function	2 (0~35)	7: Zero-current state
F10.02 (0x0A02)	RELAY function	8 (0~35)	
F10.29 (0x0A1D)	Zero current detection level	5.0% (0.0%~300.0%)	When the output current of the AC drive is less than or equal to the zero current detection level F10.29 and the duration exceeds the zero current detection delay time F10.30, the DO terminal outputs a valid signal.
F10.30 (0x0A1E)	Zero current detection delay	0.10s (0.01~600.00)	

5.8.2.2 Output Current Exceeding Limit Detection

When the output current of the AC drive exceeds the output current limit (F10.31) and the duration exceeds the output current limit detection delay time (F10.32), the DO terminal outputs a valid signal.

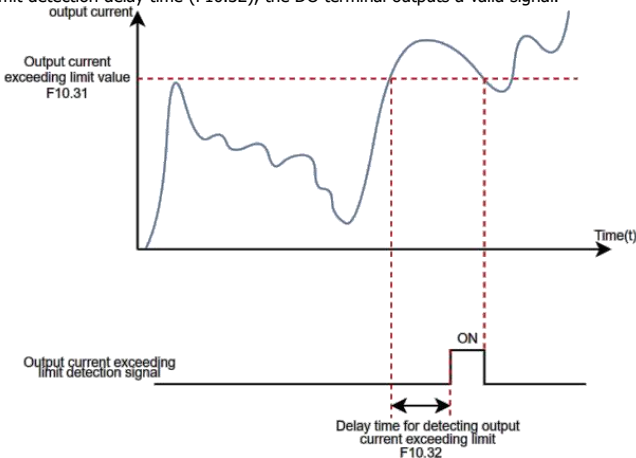

Figure 5-40 Schematic diagram of output current exceeding limit detection

Table 5-42 Output Current Over-limit Detection Related Parameters Table

Parameter code (address)	Name	Factory value (Setting range)	Parameter Description
F10.01 (0x0A01)	DO terminal function	2 (0~35)	30: Output current exceeds limit
F10.02 (0x0A02)	RELAY function	8 (0~35)	
F10.31 (0x0A1F)	Output overcurrent threshold	200.0% (0.0%~300.0%)	When the output current of the AC drive is greater than F10.31 (output current exceeding the limit value) and the duration exceeds F10.32 (output current exceeding the limit detection delay time), the DO terminal outputs a valid signal.
F10.32 (0x0A20)	Output current overrun detection delay time	0.01s (0.00~600.00)	

5.8.2.3 Arbitrary Arrival Current Detection

When the output current of the AC drive is within the range of (any reaching current \pm any reaching current 1 width) * the rated current of the motor, the DO terminal outputs a valid signal.

KC100 provides a set of arbitrary arrival current and detection width parameters, and the functional diagram is shown in the following figure.

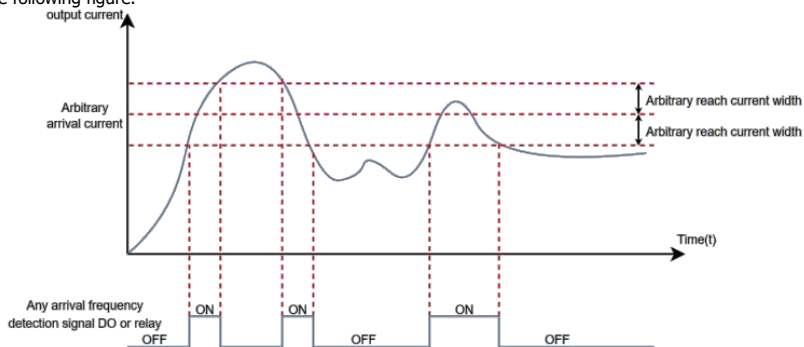
Figure 5-41 Timing Chart of Arbitrary Arrival Current
Table 5-43 Table of Relevant Parameters for Detection of Arbitrary Current Arrival

Parameter code (address)	Name	Factory value (Setting range)	Parameter Description
F10.01 (0x0A01)	DO terminal function	2 (0~35)	23: Any current reaches the output
F10.02 (0x0A02)	RELAY function	8 (0~35)	
F10.33 (0x0A21)	Detection level of current	100.0% (0.0%~300.0%)	When the output current of the AC drive is within the range of F10.33 (any arrival current) \pm F10.34 (any arrival current width) multiplied by F03.04 (motor rated current), the DO terminal outputs a valid signal.
F10.34 (0x0A22)	Detection width of current	0.0% (0.0%~300.0%)	The value of any reaching current width is F10.34 (any reaching current width) multiplied by F03.04 (motor rated current).

5.8.3 Forward and Reverse Instructions

5.8.3.1 Dead-band Time for Forward and Backward Rotation

The transition time at the output 0Hz during the forward and reverse transition process of the frequency converter is called the forward and reverse dead-band time (F02.27).

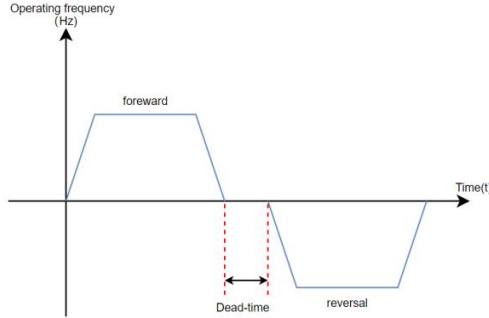

Figure 5-42 Schematic diagram of dead-band time for forward and backward rotation

Table 5-44 Table of Parameters Related to Dead-band Time for Forward and Reverse Rotation

Parameter code (address)	Name	Factory value (Setting range)	Parameter Description
F02.27 (0x021B)	FWWD/REV switchover dead zone time	0.0s (0.0s~60000.0s)	Set the transition time at output 0Hz during the forward and reverse transition process of the AC drive.

5.8.3.2 Reverse Frequency Prohibition and Rotation Direction Selection

The reverse frequency prohibition is set through parameter F02.28, and the schematic diagram of reverse frequency prohibition is shown in the following figure.

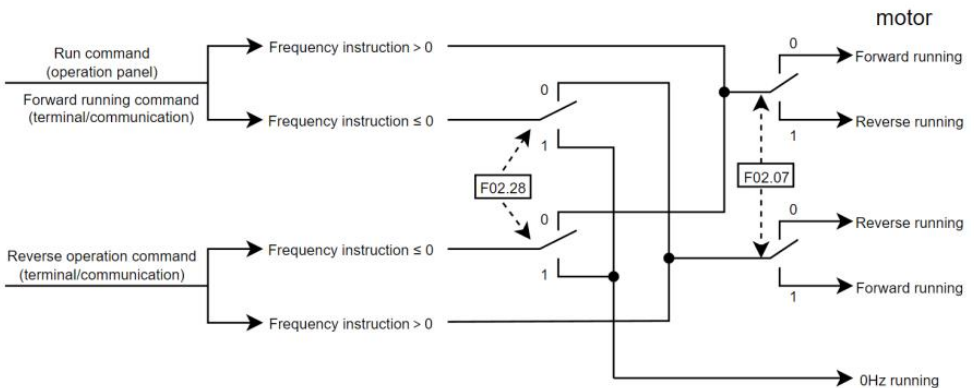

Figure 5-43 Schematic diagram of reverse frequency prohibition

Table 5-45 Parameters related to reverse frequency suppression

Parameter code (address)	Name	Content	Factory value (Setting range)	Parameter Description
F02.28 (0x021C)	Reverse control enable	0: Allow Inversion 1: Prohibit inversion	0 (0~1)	When F02.28 is valid, input a reverse command to the frequency converter, and the motor runs at zero frequency.
F02.07 (0x0207)	Rotation direction	0: Consistent direction 1: Opposite direction	0 (0~1)	By changing this parameter, the purpose of changing the direction of motor rotation can be achieved without changing the motor wiring, which is equivalent to adjusting any two lines of the motor (U, V, W) to achieve the conversion of motor rotation direction.

The forward and reverse operation of the motor is set through parameter F02.07. By changing the F02.07 parameter, the purpose of changing the motor rotation direction can be achieved without changing the motor wiring. Its function is equivalent to adjusting any two lines of the motor (U, V, W) to achieve the conversion of the motor rotation direction.

Explanation: After parameter initialization, the motor's running direction will return to its original state. Be cautious when using in situations where it is strictly prohibited to change the motor direction after system debugging.

5.8.4 PID preset frequency and PID sleep

5.8.4.1 PID preset frequency switching

After the PID preset frequency is enabled, it will start running at the preset frequency (F01.10). When the feedback voltage meets the PID initial frequency switching voltage (F16.32), the frequency source is immediately switched to PID given . The specific switching condition needs to be determined according to the PID regulation characteristic (F16.16), the relevant function code description and switch are shown in the chart.

Table 5-46 Parameters related to PID preset frequency

Parameter code (address)	Name	Factory value (Setting range)	Parameter Description
F16.31 (0x101F)	PID preset frequency enable	0 (0~1)	0: No initial frequency 1: Run at the initial frequency, the initial frequency is F01.10;
F16.32 (0x1020)	PID preset frequency switching voltage	0.00V (-10.00~10.00V)	When the PID is positive characteristic, switch to PID operation when the feedback voltage is greater than the set value; When the PID is negative characteristic, switch when the feedback voltage is less than the set value. This switching action is performed only once per run

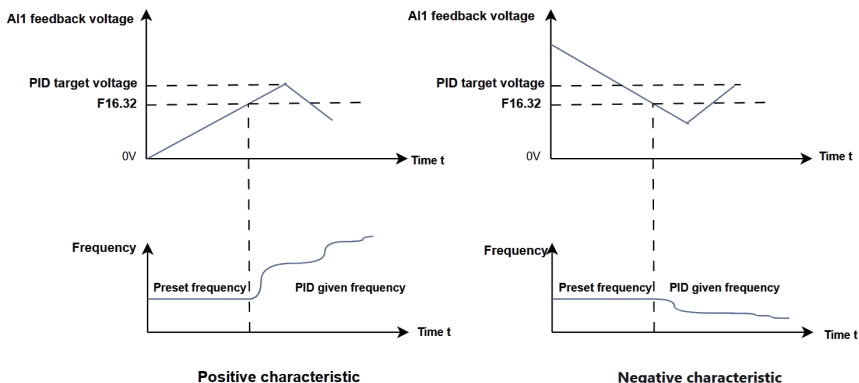

Figure 5-44 Preset frequency switching diagram



5.8.4.2 PID sleep

After PID sleep is enabled, the PID computing will be sleep or wake up according to the set voltage value (F16.34). when PID sleep, the PID will be reset and run at 0 frequency. The specific sleep logic is as follows:

Table 5-47 PID sleep parameter

Parameter code (address)	Name	Factory value (Setting range)	Parameter Description
F16.33 (0x1021)	PID sleep enable	0 (0~1)	0: PID sleep off 1: PID sleep enable
F16.34 (0x1022)	PID sleep voltage threshold	0.00V (-10.00~10.00V)	Positive characteristics: When the feedback voltage is less than (F16.34), the PID becomes 0 frequency after F16.35 time; When the voltage is greater than (F16.34), delay F16.36 to restore PID compute; Negative characteristic: When the feedback voltage is greater than (F16.34), the PID becomes 0 frequency after F16.35 time; When the voltage is less than (F16.34), delay F16.36 to restore PID compute ;
F16.35 (0x1023)	PID sleep delay time	0.1s (0.0~20.0V)	After PID meets the sleep voltage, it keeps F16.35 time and enter sleep. When the voltage recovers in the middle, the time will be reset.
F16.36 (0x1024)	PID wake up delay time	0.1s (0.0~20.0s)	After PID meets the wake up voltage, it keeps F16.36 time to resume PID compute. When the voltage recovers in the middle, the time will be reset.

Description:

1. When PID sleep and PID preset frequency are enable at the same time, the sleep can be triggered only after the PID preset frequency is switched to PID compute.
2. The feedback voltage used in this function is the voltage modified by the AI curve. For details, see D00.19.

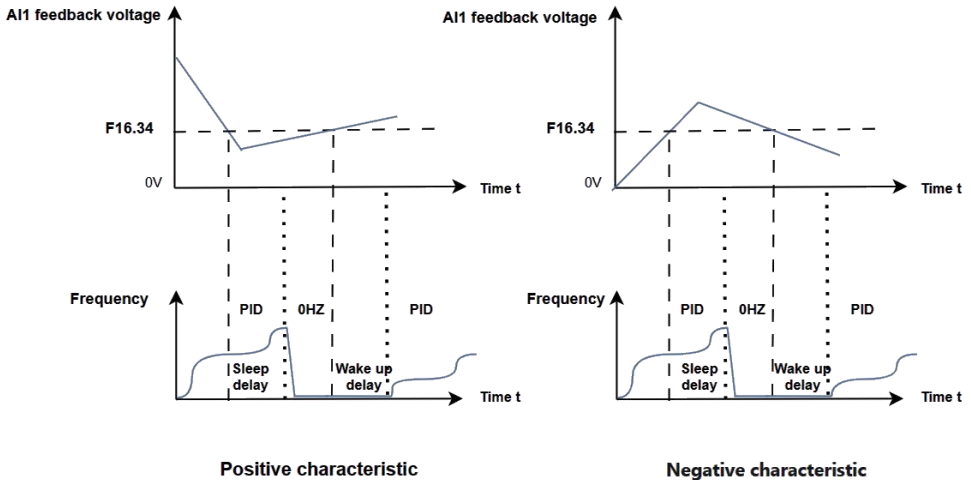

Figure 5-45 PID sleep diagram

5.9 Introduction of Auxiliary Functions

5.9.1 Hibernation and Wakeup

Hibernation function is also known as sleep function. During sleep time, the AC drive stops running.

Wakeup is a process that the AC drive wakes up from the sleep state and starts to run.

Sleep and Wakeup require setting parameters such as wakeup frequency, hibernation frequency and hibernation time, respectively. Generally, the wakeup frequency (F12.00) should be higher than or equal to the hibernation frequency (F12.02). If the wakeup frequency and hibernation frequency are both 0.00Hz, the sleep and wake functions are disabled.

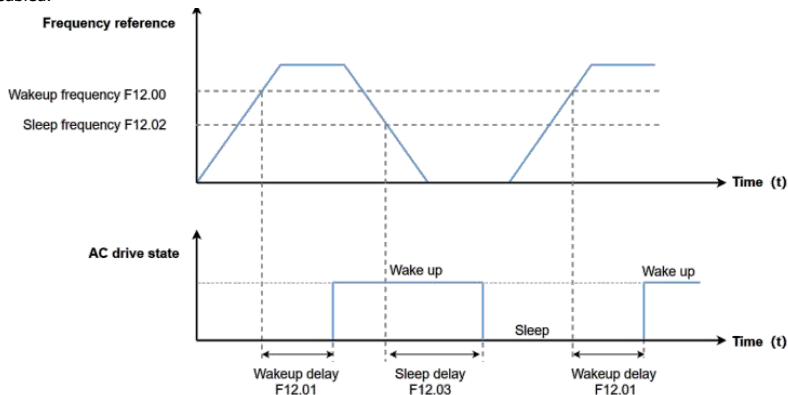

Figure 5-46 Sleep and Wakeup

Note: When sleep is enabled during PID operation, you can set F16.20 (selection of PID operation at stop) to 1 to continue the PID operation or to 0 to stop PID operation.

Table 5-48 Hibernation and Wakeup Parameters

Parameter Code (Address)	Name	Defaults (Value Range)	Adjustable properties
F12.00 (0x0C00)	Wakeup frequency	0.00 Hz (F12.02 to F01.11)	If the AC drive is in hibernation state and the current running command is effective, when the set frequency is greater than or equal to wakeup frequency (F12.00), after the wakeup delay time (F12.01), the AC drive starts directly.
F12.01 (0x0C01)	Wakeup delay	0.0 s (0.0s to 6500.0s)	
F12.02 (0x0B02)	Hibernation frequency	0.00 Hz (0Hz to F12.00)	When the frequency reference is less than or equal to the hibernation frequency (F12.02) during running, the AC drive enters the hibernation state and stops after the hibernation delay time (F12.03).
F12.03 (0x0C03)	Hibernation delay	0.0 s (0s to 6500.0s)	

5.9.2 Timing Function

When the AC drive starts each time, it starts timing from 0. After reaching the Timing duration (F12.30), the AC drive automatically stops, and the DO terminal (No.32 function) outputs an active signal. The remaining timing duration can be viewed through D00.56.

The DO terminal (No.33 function) outputs an active signal when the current running duration reaches the value of F12.31.

The DO terminal (No.34 function) outputs an active signal when the accumulative running duration reaches the value of F12.32. The accumulative running duration can be viewed through D00.57.

The DO terminal (No.35 function) outputs an active signal when the accumulative Power-on duration reaches the value of F12.33. The accumulative Power-on duration can be viewed through D00.58.

Table 5-49 Timing function related parameters table

Parameter Code (Address)	Name	Defaults (Value Range)	Parameter Description
F10.01 (0x0A01)	DO terminal function selection	2 (0 to 35)	32: Timed duration reach
F10.02 (0x0A02)	RELAY Relay function selection	8 (0 to 35)	33: Current running duration reach 34: Accumulative running duration reach 35: Accumulated power-on duration reach
F12.30 (0x0C1E)	Timing duration	0 min (0min to 6500.0min)	Used to set each running time of the frequency converter. Each time the frequency converter starts, the timing starts from 0. After reaching the scheduled running time (F12.30), the frequency converter automatically stops, and at the same time, the DO terminal (No. 32 function) outputs a valid signal. .
F12.31 (0x0C1F)	Current running duration threshold	0 min (0min to 6500.0min)	Used to set the current running time of the inverter. If the current running time exceeds F12.31, the DO terminal (function 33) outputs a valid signal.
F12.32 (0x0C20)	Running duration threshold	0 h (0h to 65000h)	Used to set the running time of the inverter. When D00.57 (accumulated running time) exceeds F12.31 (set cumulative power-on arrival time), the DO terminal (function No. 34) outputs a valid signal.
F12.33 (0x0C21)	Power-on duration threshold	0 h (0h to 65000h)	Used to set the power-on time of the inverter. When D00.58 (accumulated power-on time) exceeds F12.30 (set cumulative power-on arrival time), the DO terminal (function No. 35) outputs a valid signal.
F12.34 (0x0C22)	Timed running time unit	0 (0 to 1)	Set the unit of F12.30 timing running time.

5.9.3 Counting Function

The count values are collected through the DI terminal (DI4 is used in the case of high pulse frequency) and the DI terminal function is set to 43(counter input).

In the figure below, the counting value needs to be collected through the DI terminal, and the DI terminal function should be set to 43(counter input). When the counting value reaches the Reference count value (F12.10), the DO output an ON signal for "Reference count value reach"; When the counting value reaches the Designated count value(F12.11), the DO output an ON signal for "Designated count value reach";

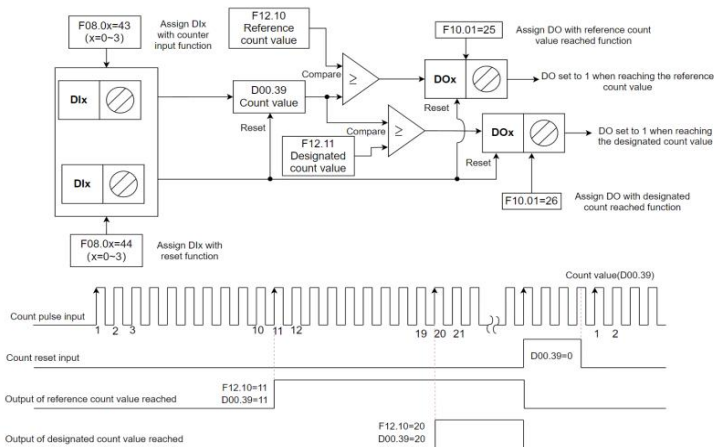

Figure 5-47 Schematic diagram of the count function

Table 5-50 Parameters related to the counting function

Parameter Code (Address)	Name	Reference	Function Description
F08.00 ~ F08.03 (Any one)	DI1 to DI4 function (Any One)	43	Counter input
F08.00 ~ F08.03 (Any one)	DI1 to DI4 function (Any One)	44	Count reset
F10.01 ~ F10.02 (Any one)	Terminal output function (Any One)	25	Reference count value reach
F10.01 ~ F10.02 (Any one)	Terminal output function (Any One)	26	Designated count value reach

Note:

- 1、 DI4 is required if the pulse frequency is high;
- 2、 A DO terminal cannot be assigned with the "reference count value reach" function and "designated count value reach" function at the same time;
- 3、 In the inverter RUN/STOP state, the counter will always count, until the "set count value" arrives to stop counting;
- 4、 The count value is retentive at power failure;
- 5、 An automatic stop system can be implemented by feeding the count value reach signal output by the DO terminal to the stop input terminal of the AC drive:

Table 5-51 Parameter table of counting value setting

Parameter Code (Address)	Name	Function Description	Defaults (Value Range)
F12.10 (0x0B0A)	Reference count value	Set counter maximum value	10000 (1 to 65535)
F12.11 (0x0B0B)	Designated count value	Set the current count value of the counter	10000 (1 to 65535)

5.9.4 Counting Function

The simple PLC can complete the simple combined operation of multi-speed instructions, and has two functions: as a frequency source or as a voltage source with VF separation. When simple PLC is used as the frequency source, the ones digit of "PLC stage setting" determines the running direction, and the ones digit of F17.17 "Simple PLC operation mode" determines the three operation cycle modes in:

0: Stop after a single cycle The inverter automatically stops after completing a single cycle, and the running command needs to be given again to start.

1: Maintain the final value After a single cycle After the inverter completes a single cycle, it will automatically maintain the last segment of operation. frequency and direction.

2: Continuous cycle After the inverter completes one cycle, it will automatically start the next cycle until there is a stop command. time to stop.

The tens digit of F17.17 "Simple PLC operation mode" determines the timing unit of the PLC stage running time, while the hundreds and thousands digits of F17.17 determine the simple PLC power-off storage method and shutdown memory method respectively. PLC power-off storage refers to memorizing the operating stage and operating frequency of the PLC before power-off, and continuing to run from the memory stage when the power is turned on next time. If you choose not to remember, the PLC process will be restarted every time you power on. PLC shutdown memory records the previous running stage and running frequency of the PLC when it stops, and continues running from the memory stage the next time it runs. If you choose not to remember, the PLC process will be restarted every time it is started.

Table 5-52 Simple PLC function parameters

Parameter code (address)	Name	Content	Factory default (Setting range)
F17.17 (0x1111)	Simple PLC operation mode	Units digit: circular mode 0: Stop after a single cycle 1: Keep the final value after a single cycle 2: Continuous loop Tens place: timing unit 0: seconds (s) 1: Minutes (min) 2: hours (h) Hundreds digit: power-off storage method 0: Do not store 1: Storage Thousands digit: shutdown memory mode 0: No memory when stopping 1: Stop memory	0x0000 (0x0000 to 0x1122)
F17.19 (0x1113)	PLC segment 0 running time	Set the running time of PLC segment 0	0.0s(min/h) (0.0 to 6500.0s(min/h))
F17.20 (0x1114)	PLC phase 0 setup	Units digit: running direction of this section 0: Same direction 1: reverse Tens digit: acceleration and deceleration time of this section 0: Acceleration and deceleration time 1 (F01.23, F01.24) 1: Acceleration and deceleration time 2 (F01.25, F01.26) 2: Acceleration and deceleration time 3 (F01.27, F01.28) 3: Acceleration and deceleration time 4 (F01.29, F01.30)	0x00 (0x00 to 0x31)
F17.21 (0x1115)	PLC first stage running time	Same as F17.19	0.0s(min/h) (0.0 to 6500.0s(min/h))
F17.22 (0x1116)	PLC phase 1 setup	Same as F17.20	0x00 (0x00 to 0x31)
F17.23 (0x1117)	PLC second stage running time	Same as F17.19	0.0s(min/h) (0.0 to 6500.0s(min/h))
F17.24 (0x1118)	PLC stage 2 setup	Same as F17.20	0x00 (0x00 to 0x31)
F17.25 (0x1119)	PLC section 3 running time	Same as F17.19	0.0s(min/h) (0.0 to 6500.0s(min/h))
F17.26 (0x111A)	PLC stage 3 setup	Same as F17.20	0x00 (0x00 to 0x31)
F17.27 (0x111B)	PLC segment 4 running time	Same as F17.19	0.0s(min/h) (0.0 to 6500.0s(min/h))

F17.28 (0x111C)	PLC stage 4 setup	Same as F17.20	0x00 (0x00 to 0x31)
F17.29 (0x111D)	PLC section 5 running time	Same as F17.19	0.0s(min/h) (0.0 to 6500.0s(min/h))
F17.30 (0x111E)	PLC stage 5 setup	Same as F17.20	0x00 (0x00 to 0x31)
F17.31 (0x111F)	PLC section 6 running time	Same as F17.19	0.0s(min/h) (0.0 to 6500.0s(min/h))
F17.32 (0x1120)	PLC stage 6 setup	Same as F17.20	0x00 (0x00 to 0x31)
F17.33 (0x1121)	PLC segment 7 running time	Same as F17.19	0.0s(min/h) (0.0 to 6500.0s(min/h))
F17.34 (0x1122)	PLC stage 7 setup	Same as F17.20	0x00 (0x00 to 0x31)

5.9.5 Fire mode function

In emergency fire mode, when the signal is triggered, the fault is shielded to ensure that the AC drive can continuously output at the set fire mode operate frequency. If the fire mode is triggered for more than 5 minutes, the function parameter D00.63 will be set to 1 and the AC drive will not be under warranty.

First, set the F13.70 (Fire mode function selection).

When F13.70=0, the fire mode is invalid and the normal mode operates. If there is a fault, the machine will shut down normally.

When F13.70=1, select fire mode 1. The AC drive will keep running unless it is damaged by itself.

When F13.70=2, select fire mode 2. The AC drive will keep running except for fault caused by hardware overcurrent.

When F13.70=3, select fire mode 3. The AC drive will keep running except for overcurrent, overvoltage, undervoltage, loss of input phase, loss of output phase, cycle-by-cycle current limiting, overload, over-temperature and short circuit fault.

When the ones unit of F13.70 is not set to 0, and the DI terminal function is set to 52 (fire mode enable). After triggering the terminal, the fire mode takes effect, and the AC drive will operate at the frequency set by F13.71 and F13.72. Meanwhile, the DO terminal function can be set to 36 (fire mode enable mark) as an output indicator.

When the tens of F13.70 is set to 0, the AC drive in the fault state cannot enter the fire mode and needs to be reset fault. When the tens of F13.70 is set to 1, even if it is in the fault state, the fault will be automatically reset after the fire mode is enabled and it will immediately enter the fire mode.

When the tens of F13.72 is set to 0, the running direction is the current given running direction, which is consistent with the direction control during normal operation. When the tens of F13.72 is set to 1, it will run according to the direction set by ones unit, and it will operate at the frequency set by F13.71. When the tens of F13.72 is set to 2, it will run according to the current frequency direction and the frequency set for F13.71.

When enabled the fire mode function selection (the ones digit of F13.70 ≠ 0) and enabled the shutdown fault detection (F13.48 ≠ 0, F13.49 ≠ 0), the AC drive will regularly detect short-circuit fault and motor phase-loss (commonly used in fire pumps that do not run all year round). When a fault occurs, a short-circuit or phase-loss fault will be reported, and D00.64 will display the shutdown status fault detection result.

Table 5-53 Fire mode function related parameter table

Parameter code (address)	Name	Content	Factory default (Setting range)
D00.63 (0x603F)	Fire mode warranty mark	0: Warranty within the warranty period 1: No warranty within the warranty period	-
D00.64 (0x6040)	Stop fault detection flag	0: Shutdown fault detection is not enabled or Shutdown fault detection is enabled but there are currently no ground short circuit, phase-to-phase	-

		short circuit, or output phase loss fault 1: Short circuit to ground fault 2: Phase-to-phase short circuit 3: Phase-loss fault	
F13.48 (0x0D30)	Shutdown fault detection enable	Ones: Shutdown to ground short circuit detection enable 0: Disabled 1: Enabled Tens: Shutdown phase-to-phase short circuit detection enable 0: Disabled 1: Enabled	0x00 (0x00~0x11)
F13.49 (0x0D31)	Shutdown fault detection interval time	The fire mode function (The ones of F13.70 is not zero) has been set, and the shutdown fault detection enable has also been set. During the shutdown state, fault detection will be conducted at the specified interval. If set to 0, no detection will be performed.	0s (0s~6000s)
F13.70 (0x0D46)	Fire mode function selection	Ones: 0: Fire mode invalid 1: Fire mode 1 2: Fire mode 2 3: Fire mode 3 Tens: 0:Manual reset fault 1:Automatic reset fault	10 (00~13)
F13.71 (0x0D47)	Fire mode operate frequency	When F13.70 is not set to 0 and the fire signal is triggered , the fire mode is effective and the AC drive will operate at the frequency set by F13.71	0.00Hz (0Hz~F01.11)
F13.72 (0x0D48)	Fire mode motor operation mode	Ones: operation direction 0: Same direction 1: Opposite direction Tens: operation frequency 0: Run in the currently frequency and direction 1: Run according to the direction set for the ones units and the frequency set for F13.71 2:Run according to the current frequency direction and the frequency set for F13.71	00 (00~21)

5.10 User Password

Password Settings:

If F00.00 is set to a non-zero value (password protection is enabled), the parameter menu is accessible only after the correct password is entered. Password authentication is required every time you access the parameter menu again.

Password cancellation:

Set F00.00 to 0, which cancels the user password protection.

5.11 Parameter Initialization and Upload-download

5.11.1 Initialize (Restore Default Settings)

Set F00.04 to 01 or 02, you can restore all parameters to their default Settings, and after initialization, F00.04 returns to 0.

Table 5-54 Parameter Initialization F00.04 function table

F00.04 (Value Range)	Content	Instructions
1	Restore default settings (excluding motor parameters)	The following parameters cannot be restored to default values: <ul style="list-style-type: none"> • Motor parameters • Fault record information • IGBT heatsink temperature (D00.14) • Accumulative running duration (D00.57) • Accumulative power-on duration (D00.58) • Accumulative power consumption (D00.59,D00.60)
2	Restore default settings (including motor parameters)	The following parameters cannot be restored to factory values: <ul style="list-style-type: none"> • IGBT heatsink temperature (D00.14) • Accumulative running duration (D00.57) • Accumulative power-on duration (D00.58) • Accumulative power consumption (D00.59,D00.60)
3	Clear fault records	Clear the following parameters: <ul style="list-style-type: none"> • Fault records (D01 group) • Accumulative running duration (D00.58), Accumulative power consumption (D00.59) • Accumulative power consumption (D00.59,D00.60)

5.11.2 Upload and Download

When the AC drive is connected to the external keyboard, all current parameters can be uploaded to the external keyboard storage space for backup or copying by setting the function code F00.05 to 1. You can download the parameters back to the frequency converter or copy them to another device by setting F00.06 to 1 or 2.

Table 5-55 Upload and download select parameter table

Parameter code (address)	Name	Content	Defaults (Value Range)	Parameter description
F00.05 (0x0005)	Parameter upload	0: None Operation 1:Parameters uploaded to keyboard storage space	0 (0 to 1)	Upload the current parameters to the external keyboard, and set to 0 automatically after uploading;
F00.06 (0x0006)	Parameter download	0: No operation 1: Download parameters from Keyboard storage space (excluding motor parameters) 2: Download parameters from Key board storage space (including Motor parameters)	0 (0 to 2)	The value in the storage space of the external keyboard is downloaded back to the AC drive, and automatically set to 0 after the download is completed;

5.12 Terminal and AC drive status bit description

The status bit function codes are all represented in hexadecimal. After reading, they can be converted into the corresponding 16-bit binary to view the relevant status.

5.12.1 AC drive status

When the AC drive is powered on and in operation, the 16-bit binary of the function code can be used to observe the current status of the AC drive .

Table 5-56 AC drive status

Parameter code (address)	Name	Content	Parameter description
D00.13 (0x600D)	Inverter running status	See table 5-57	Indicates the operation, forward and reverse , self-learning and other states of the AC drive

Table 5-57 D00.13 Status bit description

Bit	Name	Content	Bit	Name	Content
Bit0	Running status	0:Stop 1:Running 2:Sleep	Bit8	Control method	0:Speed control 1:Torque control
Bit1			Bit9	Reverse	0
Bit2	Running direction	0:Forward 1:Reverse	Bit10	Reverse	0
Bit3	Fault status	0:Normal 1:Fault	Bit11	Overvoltage stall	0: Non overvoltage stall 1: Overvoltage stall
Bit4	Reverse	0	Bit12	Automatic current limiting	0:Non automatic current limiting 1:Automatic current limiting
Bit5	Acceleration and deceleration status	0:Constant speed 1:Accelerating 2:Decelerating	Bit13	Reverse	0
Bit6			Bit14	Reverse	0
Bit7	DC brake status	0:Non DC brake 1:DC brake	Bit15	Reverse	0

5.12.2 DI status

The DI input status (D00.16) stores the DI input terminal signal. DI1-DI4 correspond to the 16-bit binary values of function code from bit 0 to bit3. The bit10 of the 16-bit binary function code correspond to the expansion terminal signals AI. When AI is enabled as a DI function (F18 group), an AI input less than 3V corresponds bit 10=0, and an AI input greater than 7V corresponds bit10= 1;

Table 5-58 DI input status

Parameter code (address)	Name	Content	Parameter description
D00.16 (0x6010)	DI input status	See table 5-58	DI input terminal signal

Table 5-59 D00.16 (DI input status description)

Bit15	Bit12	Bit11	Bit10	..	Bit5	Bit4	Bit3	Bit2	Bit1	Bit0
					AI				DI4	DI3	DI2	DI1

Example:

When DI3 =1, read D00.16 value is: 0x0004, corresponding binary shown in the table below:

Table 5-60 DI input example

Bit15	Bit12	..	Bit9	...	Bit5	Bit4	Bit3	Bit2	Bit1	Bit0
0	0	0	0	0	0	0	0	0	0	1	0	0

5.12.3 DO status

When DO as digital output , DO corresponding to the Bit1 of the 16-bit binary function code. RELAY corresponding to the Bit2 of the 16-bit binary function code;

Table 5-61 DO output status

Parameter code (address)	Name	Content	Parameter description
D00.17 (0x6011)	DO output status	See table 5-61	Output status

Table 5-62 DO output status bit

Bit15	Bit4	Bit3	Bit2	Bit1	Bit0
										RELAY	DO	

5.13 Fault and Protection

5.13.1 Startup Protection

By setting F02.08 to 1, startup protection is enabled to prevent the motor from responding to a command upon unexpected power-on or fault reset of the AC drive.

The startup protection works in the following two scenarios:

1. If a command is issued upon power-on of the AC drive (for example, the terminal used as the command source are ON before power-on), the AC drive does not respond to the command. Instead, the AC drive responds only after the command is revoked and re-issued.
2. If a command is issued upon fault reset of the AC drive, the AC drive does not respond to the command. Instead, the AC drive responds only after the command is revoked and re-issued.

Table 5-63 Select parameters for starting protection

Parameter code (address)	Name	Content	Defaults (Value Range)	Parameter description
F02.08 (0x0208)	Startup Protection	0: Disabled 1: Enabled	0 (0 to 1)	The AC drive is equipped with the startup protection function to prevent the motor from responding to a command upon unexpected power-on or fault reset.

5.13.2 Undervoltage/Overvoltage Threshold

Table 5-64 Setting parameters of undervoltage point and overpressure point

Parameter Code (address)	Name	Content	Defaults (Value Range)	Parameter description
F13.29 (0x0D1D)	Undervoltage threshold	When the bus voltage falls below F13.29 , the AC drive reports a fault.	220V model: 200.0V 380V model: 350.0V 440V model: 350.0V (150.0V to 700.0V)	When the bus voltage exceeds the F13.19, the E0004-E0006 is reported. When the bus voltage is lower than the F13.29, the E0007 is reported during operation
F13.19 (0x0D13)	Overvoltage threshold	Set bus overvoltage threshold	220V model: 400.0V 380V model: 820.0V 440V model: 820.0V (350.0V to 820.0V)	

5.13.3 Phase Loss Protection

Table 5-65 Parameters for phase loss Settings

Parameter code (address)	Name	Content	Defaults (Set range)	Parameter description
F13.34 (0x0D22)	Input phase loss Protection	0: Disables 1: Enable	1 (0 to 1)	KC100 inverter does not detect the input voltage, for the

F13.35 (0x0D23)	Input phase loss detection level	Input phase loss detection level	10% (5 to 50%)	three-phase 220V and 380V models, by detecting the ripple of the bus voltage to determine whether the input is out of phase, so the input is out of phase fault only when adding a certain load.
F13.36 (0x0D24)	Input phase loss detection time	Input phase loss detection time	10ms (5 to 2000ms)	
F13.37 (0x0D25)	Output phase loss protection	Ones: Output phase loss protection Tens: Output phase loss protection before 0: Disabled 1: Enable	01 (00 to 11)	Ones: This bit defines whether to enable output phase loss protection. If the protection is disabled and output phase loss occurs, the AC drive will not report the fault. In this case, the actual current is larger than the current displayed on the operating panel, which is risky. Exercise caution when disabling this function. Tens: Output phase loss detection during running takes about several seconds. For low frequency running applications or applications where risks exist in start with phase loss, this function enables quick detection of output phase loss during startup. However, it is not recommended for applications that have strict requirements on startup time.

5.13.4 Fault Resetting

The undervoltage fault (E0007) is automatically reset when the bus voltage resumes normal, and the reset is not included in the auto reset count. The short-to-ground fault (E0010) cannot be reset automatically or manually, only through the AC drive completely power off, and then reset after powering on again. Fault protection action selection is required when the set number of fault auto reset times is reached.

Table 5-66 Fault reset parameters

Parameter code (address)	Name	Content	Defaults (Set range)	Parameter description
F13.60 (0x0D3C)	Auto reset attempts	Number of automatic resets	0 (0 to 20)	This parameter defines the maximum number of auto resets allowed for the AC drive when the fault protection action is set to auto reset. If the number of reset attempts exceeds the value of this parameter, the AC drive will remain in the faulty state. note:The undervoltage fault (E0007) is automatically reset when the bus voltage resumes normal, and the reset is not included in the auto reset count.
F13.61 (0x0D3D)	DO action during auto reset	0: Disabled 1: Enabled	0 (0 to 1)	During the automatic reset of the inverter fault, whether the fault output function of the digital output terminal is effective. The fault output power of the digital output terminal is defined by F10.01=8.
F13.62 (0x0D3E)	Auto reset interval	the waiting time after a fault	1.0 s (0.1s to 100.0s)	The waiting time between the frequency converter fault alarm and the automatic fault reset.

5.13.5 Fault Action Protection Selection

Table 5-67 Fault action protection parameters

Parameter code (address)	Name	Content	Factory Defaults (Set range)
F13.65 (0x0D41)	Fault protection action selection 1	Ones : Input phase loss Tens : Output phase loss Hundreds: reserved Thousands: reserved Ten thousands: Load loss 0: Coast to stop 1: Decelerate to stop 2: Continue to run	00000 (0 to 20022)
F13.66 (0x0D42)	Fault protection action selection 2	Ones : External fault Tens : Communication exception Hundreds: EEROM Communication exception Thousands: PID feedback loss Ten thousands: reserved 0: Coast to stop 1: Decelerate to stop 2: Continue to run	00000 (0 to 02222)
F13.67 (0x0D43)	Fault protection action selection 3	Ones : Accumulative running duration reach Tens : Accumulative power-on duration reach Hundreds: User-defined fault Thousands: reserved Ten thousands: reserved 0: Coast to stop 1: Decelerate to stop 2: Continue to run	00000 (0 to 02222)

6 Fault Handling

6.1 Common Faults and Diagnosis

6.1.1 Alarm and Fault Display

When the AC drive fails, the fault alarm display screen appears in the operation panel, and the fault relay acts, the AC drive stops the output, and the motor stops freely.

For example: "E0001" accelerated overcurrent error, ALM light flashing.

The following figure shows the fault display screen:



Figure 6-1 The interface fault display



Do not repair or modify the AC drive by yourself. In case of any fault that cannot be rectified, contact the agent or Kinco for technical support.

6.1.2 Restart Upon Faults

Table 6-1 Restart upon faults

Stages	Treatment Measures	Instructions
When a fault occurs	View the last three fault types, fault frequency/current / voltage / bus voltage / inverter temperature / input / output terminal status / power and running time through the operation panel display	View it through the D01 group.
Before fault reset	Locate and rectify the fault cause based on the fault code displayed on the operating panel.	If the fault cannot be removed or the fault cause is not clear, please contact the manufacturer directly.

Method of fault reset	Set the DI to function 16(F08.00~F08.03 =16 fault reset), and make the terminal valid, reset the fault.	Serious faults such as ground short circuit fault, contactor overload fault and repeated hardware overcurrent cannot be reset directly reset, and must be reset by method 4.
	Reset by the  STOP key in the operator panel.	
	Use a host controller for reset (for communication control mode). Verify that F01.03=2 (communication control mode) and write "0008" (fault reset) to the communication address 7000H by using the host controller.	
	Power off and then power on the AC drive for automatic reset. Disconnect the main circuit power supply and reconnect the power supply after the display on the operating panel disappears.	All faults caused by device damage or short circuit to ground of external output can be reset by this method.

6.1.3 Common Troubleshooting

Table 6-2 Symptoms and troubleshooting

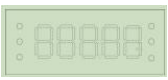
Serial Number	Fault symptoms	Possible cause	Solutions
1	 Digital tube does not display, the inverter does not start	The grid voltage is not input or too low	Check the input power supply
		The switched-mode power supply (SMPS) on the drive board of the AC drive is faulty	Check whether the 24 V output voltage and 10 V output voltage on the control board are normal
		The frequency converter buffer resistance is damaged	Contact Kinco.
		Control board, keyboard failure	
		The buffer resistor of the AC drive is damaged	
		The control board or operating panel is faulty	
The rectifier bridge is damaged.			
2	"E0010" alarm is displayed upon power-on.	The motor or output cable is shorted to ground.	Measure the insulation of the motor and output lines with universal
		AC drive damage	Seek manufacturer service Contact Kinco.
3	The motor does not rotate when the AC drive is running.	The AC drive and motor are incorrectly connected.	Double check the connection between the AC drive and motor
		Related AC drive parameters (motor parameters) are set incorrectly.	Restore the AC drive to factory settings and reset the following parameters correctly
			Check F01.03(Running Command Channel) and set it correctly V/f mode, heavy load start, adjust F05.07(torque boost) parameter or F05.12 and F05.13 (on-line torque compensation gain)
	Drive board failure	Contact Kinco	



4	DI terminals are inactive.	Related parameters are set incorrectly	Check and set parameters in group F08 again
		External signal transmission errors occur	Re-connect external signal cables
		The control board is faulty	Contact Kinco
5	The motor coasts to stop, or braking is disabled during deceleration or deceleration to stop	overvoltage stall protection is enabled	If a braking resistor is configured, set F13.10=0 to disable overvoltage stall suppression
6	The AC drive reports overcurrent and overvoltage frequently	Motor parameters are incorrectly set.	Adjust motor parameters or perform motor auto-tuning again.
		The acceleration/deceleration time is improper.	Set acceleration/deceleration time properly
		The load fluctuates.	Contact Kinco
7	E0026 (inverter over temperature) is reported frequently.	The load frequency setting is too high or fails to automatically reduce the load frequency according to the temperature rise	Lower load frequency (F01.40) enables automatic lower load frequency (F01.41=1) according to the temperature rise
		The fan is damaged, or the air filter is blocked.	Replace the fan or clean the air filter.
		Components (thermistor or other devices) inside the AC drive are damaged.	Contact Kinco

6.1.4 Different Control Mode Under Trial Operation Treatment Countermeasures

6.1.4.1 V/F Control Mode

V / F control mode (F01.02=0, factory default value), in this mode, the drive controls the speed and torque of motor in scenarios without an encoder for speed feedback. Motor auto-tuning is required to obtain motor-related parameters.

Table 6-3 Troubleshooting in V/F mode

Problem	Solution
Motor oscillation during running	Decrease the value of F05.16 (V/f oscillation suppression gain) by increments of 5. The minimum value is 5.
The current is too large in the operation	<ul style="list-style-type: none"> Set F03.03 (rated motor voltage) and F03.054 (rated motor frequency) correctly. Decrease the value of F05.07 (torque boost) by increments of 0.5%.
The motor is loud	Increase the value of F01.40 (carrier frequency) by increments of 1.0 kHz. Note that an increase in the carrier frequency will result in an increase in the leakage current of the motor.
Sudden increased load overcurrent, accelerated overcurrent	<ul style="list-style-type: none"> Increase the drain velocity gain (F13.02) by 10; reduce the velocity current (F13.01) by 10%.

Overload report and deceleration report overpressure	<ul style="list-style-type: none"> ● Confirm that the overvoltage stall enabling force (F13.10) is set to the enabling state; ● Reduce the overvoltage action voltage (F13.11) in 10V. ● Increase the overvoltage stall gain (F13.12/F13.13), increase in 10;
--	--

6.1.4.2 Open-loop Vector Control Mode

Open-loop vector control mode (F01.02=1), which controls the speed and torque of the motor without encoder speed feedback. In this control mode, learning is learning to complete the automatic setting of motor parameters.

Table 6-4 Countermeasures in open-loop vector control mode

Problems	Solution
Overload or overcurrent reported during motor startup	according to the motor nameplate Perform motor auto-tuning (by setting F03.09). Dynamic auto-tuning on all parameters of the motor is preferred when possible
Slow torque or speed response and motor vibration at frequencies below 5 Hz	<ul style="list-style-type: none"> ● In the case of slow motor torque or speed response, increase the value of F06.00 (speed loop proportional gain) by increments of 10 or decrease the value of F06.01 (speed loop integral time) by decrements of 0.05; ● In the case of motor vibration, decrease the value of F06.00 and increase the value of F06.01.
Slow torque or speed response and motor vibration at frequencies above 5 Hz	<ul style="list-style-type: none"> ● In the case of slow motor torque or speed response, increase the value of F06.02 (speed loop proportional gain) by increments of 10 or decrease the value of F06.03 (speed loop integral time) by decrements of 0.05; ● In the case of motor vibration, decrease the value of F06.02 and increase the value of F06.03.
Low speed accuracy	In the case of excessive speed deviation during with-load operation, increase the value of F06.06 (vector control slip compensation gain) by increments of 10%.
Large speed fluctuation	In the case of abnormal motor speed fluctuation, increase the value of F06.07 (speed filter time) by increments of 1ms.
Loud motor noise	Increase the value of F01.40 (carrier frequency) by increments of 1.0 kHz. Note that an increase in the carrier frequency will result in an increase in the leakage current of the motor.
Insufficient motor torque or insufficient output	Check whether the torque upper limit is set too low. If yes, increase the value of F06.12 (torque upper limit) in speed control mode or increase the torque reference in torque control mode.

6.2 List of Fault Codes

The following faults may occur during the use of the AC drive. Troubleshoot the faults according to the solutions described in the following table.

Table 6-5 Fault codes

Fault name	Operation panel display	Troubleshoot the cause of the failure	Troubleshooting countermeasures
Accelerate over current	E0001	Ground or short circuit in the converter output circuit	Check the motor or interrupt contactor for a short circuit.
		Manual torque lift or V /F curve is inappropriate for control mode for V/F	Adjust the manual lift torque or V/F curve.

		The control mode is SVC without parameter tuning	Set the motor parameters according to the motor nameplate and tune the motor parameters.
		Rapid acceleration condition, the acceleration time is set is too short	Increase the acceleration time (F01.23).
		Excessive loss rate suppression is not set properly	<ul style="list-style-type: none"> Verify that the flow suppression function (F13.00) is enabled; the flow current (F13.01) is too high; the flow suppression gain (F13.02) is too small.
		If the load increases instantly or connects, the contactor connected to the motor is suddenly disconnected and reengaged	Enabling the wave-limiting function (F13.04=1).
		No brake resistance is installed	Install the brake resistance.
		Externally disturbed	Through the historical fault record, check whether the current value reaches overcurrent during the fault. If not reached, it is external interference, and the external interference source is checked to remove the fault. After investigation if there is no external interference source, it may be the drive plate or Hall device damage, and you need to contact the manufacturer for replacement.
Decelerating overcurrent	E0002	The output circuit of the inverter is grounded or short-circuited	Detect the motor for short circuit or open circuit.
		The control mode is SVC and no parametric tuning is performed	Set motor parameters according to motor nameplate and perform motor parameter tuning.
		Under rapid deceleration condition, the deceleration time is set too short	Increase deceleration time (F01.24).
		Excessive loss rate suppression is not set properly	<ul style="list-style-type: none"> Confirm that over loss rate suppression (F13.00) is enabled; Over loss quick acting current (F13.01) set value is too large; Over loss speed suppression gain (F13.02) is set too small.
		The load is increased instantaneously or the contactor connected to the motor is suddenly disconnected and re-drawn	Enable wave by wave current limiting (F13.04)
		No brake resistance added	Brake resistors are installed.
		Subject to external interference	Based on the historical fault records, check whether the current value during the fault reaches the overcurrent. If it does not reach the current value, it is judged that it is external interference. It is necessary to troubleshoot the external interference sources and remove the fault. If no external interference source is found, the driver board or Hall component may be damaged, and you need to contact the manufacturer to replace it.
Constant speed overcurrent	E0003	Ground or short circuit in the converter output circuit	Check the motor for a short circuit or open circuit.
		The control mode is SVC without parameter tuning	Set the motor parameters according to the motor nameplate and tune the motor parameters.
		Excessive loss rate suppression is not set properly	<ul style="list-style-type: none"> Verify that the suppression function (F13.00) is enabled; the current (F13.01) is too high; the gain (F13.02) is too small.



		If the load increases instantly or connects, the contactor connected to the motor is suddenly disconnected and reengaged	Enabling the wave-limiting function (F13.04=1).
		The selection of frequency converter is too small	In the stable running state, if the operating current has exceeded the rated current of the motor or the rated output current value of the frequency converter, please choose the frequency converter with a larger power level.
		Externally disturbed	Through the historical fault record, check whether the current value reaches overcurrent during the fault. If not reached, it is external interference, and the external interference source is checked to remove the fault. If there is no external interference source after investigation, it may be that the drive plate or Hall device is damaged, and contact the manufacturer for replacement.
Accelerated overvoltage	E0004	The input grid voltage is high	Adjust the voltage to the normal range.
		External force drags the motor during the acceleration process	Cancel the external force or install brake resistance.
		The overvoltage suppression setting is not appropriate	Verify that the overvoltage suppression function (F13.10) is enabled; the overvoltage (F13.11) is too high; the overvoltage suppression frequency gain (F13.12) is too small.
		No brake unit and brake resistance are installed	Install the brake unit and the resistance.
		The acceleration time is too short	Increase the acceleration time (F01.23).
Slow down overvoltage	E0005	The overvoltage suppression setting is not appropriate	Verify that the overvoltage suppression function (F13.10) is enabled; the overvoltage (F13.11) is too high; the overvoltage suppression frequency gain (F13.12) is too small.
		External force drags the motor during the deceleration process	Cancel the external force or install brake resistance.
		The deceleration time is too short	Increase the deceleration time.
		No brake unit and brake resistance are installed	Install the brake unit and the resistance.
Constant speed overvoltage	E0006	The overvoltage suppression setting is not appropriate	Verify that the overvoltage suppression function (F13.10) is enabled; the overvoltage (F13.11) is too high; the overvoltage suppression frequency gain (F13.12) is too small.
		There is an external force dragging the motor during the operation	Cancel the external force or install brake resistance.
Undervoltage fault	E0007	Instantaneous power failure	The instantaneous stop function (F13.20) can prevent the instantaneous power failure and undervoltage failure.
		The input voltage of the inverter is not in the range required by the specification	Adjust the voltage to the normal range.
		Bus voltage is abnormal	Looking for technical support.
		Rectifier part, the inverter drive board, the inverter control board is abnormal	Looking for technical support.
FO fault	E0008	Ground or short circuit in the converter output circuit	Check the motor or interrupt contactor for a short circuit.
		Manual torque lift or V /F curve is inappropriate for control mode for V/F	Adjust the manual lift torque or V/F curve.
		The control mode is SVC without parameter tuning	Set the motor parameters according to the motor nameplate and tune the motor parameters.
		Acceleration/Deceleration time is set is too short	Increase the acceleration time (F01.23)/ deceleration time(F01.24).

		Excessive loss rate suppression is not set properly	<ul style="list-style-type: none"> Verify that the flow suppression function (F13.00) is enabled; the flow current (F13.01) is too high; the flow suppression gain (F13.02) is too small.
		If the load increases instantly or connects, the contactor connected to the motor is suddenly disconnected and reengaged	Enabling the wave-limiting function (F13.04=1).
		No brake resistance is installed	Install the brake resistance.
		Externally disturbed	Through the historical fault record, check whether the current value reaches overcurrent during the fault. If not reached, it is external interference, and the external interference source is checked to remove the fault. After investigation if there is no external interference source, it may be the drive plate or Hall device damage, and you need to contact the manufacturer for replacement.
		Module internal damage	Check whether the module voltage drop in the main loop is normal
Short-circuit fault between output phases	E0009	Short-circuit fault between output phases	Replace and check the cable or motor for three phase short circuit.
Short-circuit to the ground fault	E0010	Motor short circuit to ground	Replace and check the cable or motor for a short circuit to the ground.
Current detection fault	E0011	The frequency converter current sampling is abnormal	Check the main circuit for power-up.
		The frequency converter current sampling is abnormal	The Hall sensor is damaged, the current sampling current is damaged, contact the manufacturer.
Wave by wave limiting fault	E0012	Whether the load is too large or the motor blocked	Reduce the load and check the motor and mechanical condition.
		The selection of frequency converter is too small	Choose the frequency converter with a larger power level.
Motor tuning fault	E0013	Motor parameters are not set according to the nameplate	Set the motor parameters correctly according to the nameplate.
		Parameter identification process has timed out	Check the inverter to the motor leads.
Input phase loss	E0014	Three-phase input power supply is abnormal	Check the input RST wiring and three-phase input voltage.
		The input phase detection level and detection time are too small	Increase the input phase absence detection level (F13.35) and the input phase absence detection time (F13.36) appropriately.
		Drive plate, lightning protection board, main control board, rectifier bridge are abnormal	Looking for technical support.
Output phase loss	E0015	Motor failure	Check whether the motor is open circuit.
		The lead from the frequency converter to the motor is not normal	Troubleshoot the peripheral faults.
		The three-phase output of the frequency converter is unbalanced during the motor operation	Check whether the three-phase winding of the motor is correct and troubleshooting.
		Drive board, IGBT module is abnormal	Looking for technical support.
Buffer resistance overload fault	E0018	Repeated bus voltage undervoltage recovery	Check the input power supply.
Frequency converter overload	E0023	The selected AC drive is too small	Select a AC drive with a higher power rating
		Whether the load is too large or the motor blocked	Reduce the load and check the motor and mechanical condition.
Motor overload	E0024	Whether the motor protection parameter F13.41 is set properly	Set this parameter correctly and increase F13.41 to extend the motor overload time.
		Whether the load is too large or the motor blocked	Reduce the load and check the motor and mechanical condition.
The load failure	E0025	The operating current of the	Check whether the load is detached or

		frequency converter is less than F13.44	whether the parameter settings of F13.44 and F13.45 meet the actual operating conditions.
The module overheating	E0026	The ambient temperature is too high	Reduce the ambient temperature.
		The air duct is blocked	Clean the air duct.
		Fan damage	Change the fan.
		The module thermistor is damaged	Looking for technical support.
		Module damage	Looking for technical support.
External equipment failure	E0028	Enter the external fault through the multifunctional terminal DI	Check for peripheral faults, confirm that the machine allows re-starting, and check whether the starting protection is enabled (F02.08), and reset the operation.
Communication failure	E0029	The upper computer is not working properly	Check the upper machine wiring.
		The communication line is not normal	Check the communication cable.
		Communication parameter F14 group was not set incorrectly	Set the communication parameters correctly.
		Other reasons	Try to restore the factory settings.
EEPROM Read-write fault	E0030	EEPROM Chip is damaged	Contact Kinco.
Run-time PID feedback loss fault	E0031	The PID feedback is less than the F16.29 setting value	Check the PID feedback signal or set F16.29 as an appropriate value.
During the cumulative operation, the fault is reached in between operations	E0032	The cumulative running time has reached the set point	Clear the record information by using the parameter initialization function.
The accumulated power-on time reaches the fault	E0033	The cumulative power-on time reaches the set value	Clear the record information by using the parameter initialization function.
User-defined fault	E0034	Enter the signal of the user-defined fault through the multifunctional terminal DI	Change the corresponding terminal level status or cancel the custom fault, and reset the operation.
Excessive speed deviation and large fault	E0041	Parameter tuning was not performed	Conduct motor parameter tuning.
		The detection parameters F13.52 and F13.53 are not set properly	Set the detection parameters reasonably according to the actual situation.

7 Quick List Of Function Parameters

7.1 Parameter Terminology Description

Table 7-1 Terminology and descriptions of control mode

Terminology	Content
Changeable at any time	Parameters that can be modified while running
Changeable only at stop	Parameters that cannot be modified while running
Unchangeable	This parameter can only be read, not modified

7.2 Parameters List

Table 7-2 Parameter types of this product

Parameters	Name	Parameters	name
F00.00	User password	F09.2x-F09.3x	AI Curve
F00.02	Menu Mode Selection	F10.0x	DO Output functions
F00.04-F00.06	Parameter initialization	F10.1x	DO Delay
F01.0x-F01.1x	Basic instructions	F10.20-F10.26	Frequency detection
F01.2x-F01.3x	Acceleration and deceleration parameters	F10.29-F10.35	Current detection
F01.4x	Carrier parameters	F11.0x-F11.1x	AO Terminal function parameters
F02.0x	Start commands	F12.0x	Hibernation function parameters
F02.1x	Speed tracking command	F12.3x	Timing function parameters
F02.2x	Stop instructions	F13.0x	Current protection parameters
F02.30- F02.35	Jogging instruction	F13.1x-F13.2x	Voltage protection parameters
F02.37- F02.40	Skip frequency	F13.33-F13.35	Phase loss protection parameters
F03.0x	Motor parameters	F13.4x	Load protection parameter
F03.1x	Asynchronous motor parameters	F13.5x	Speed deviation protection parameters
F05.00-F05.06	V/f curve	F13.60-F13.62	Fault reset
F05.07-F05.08	Torque boost	F13.65-F13.67	Failsafe action selection
F05.09-F05.14	Slip compensation	F14.0x	Communication parameter
F05.15-F05.16	Oscillation suppression	F15.0x	Display parameter function selection
F05.2x	V/f separation	F15.1x	Run/Stop display parameters
F06.0x-F06.1x	Speed loop parameters	F16.0x-F16.3x	PID parameters
F07.0x	Current loop parameters	F17.00-F17.15	Multi-reference parameter
F08.0x-F08.1x	DI Terminal function	F18	Extended terminal parameter
F08.2x	High speed pulse frequency	F19	Communication mapping parameter
F08.3x	DI Filtering time	D00.0x-D00.5x	Basic monitoring
F08.4x	DI Delay time	D01	Fault monitoring
F09.0x-F09.1x	AI Basic parameters	D02.0x-D02.1x	System Info

7.3 Group F00: Environmental Applications

Parameter (address)	Name	Reference	Default (Setup range)	Adjustable properties
F00.00 (0x0000)	User password	This parameter defines the user password	0 (0 to 65535)	Changeable at any time



F00.02 (0x0002)	Menu modes selection	0: Standard menu 1: Verify menu	0 (0 to 1)	Changeable at any time
F00.04 (0x0004)	Parameters initialization	0: No operation 1: Restore default settings (excluding motor parameters) 2: Restore default settings (including motor parameters) 3: Clear fault records	0 (0 to 3)	Changeable only at stop
F00.05 (0x0005)	Parameters upload	0: No operation 1: Upload parameters to keyboard storage space	0 (0 to 1)	Changeable only at stop
F00.06 (0x0006)	Parameters download	0: No operation 1: Download parameters from Keyboard storage space (excluding motor parameters) 2: Download parameters from Keyboard storage space (including motor parameters)	0 (0 to 2)	Changeable only at stop

7.4 Group F01: Basic Parameters Group

Parameter (address)	Name	Reference	Default (Setup range)	Adjustable properties
F01.02 (0x0102)	Motor control mode	0: V/f control 1: Sensorless vector control (SVC)	0 (0 to 1)	Changeable only at stop
F01.03 (0x0103)	Operation command source	0: Operating panel control 1: Terminal I/O control 2: Communication control	0 (0 to 2)	Changeable only at stop
F01.04 (0x0104)	Main frequency source X	0: Operating panel digital setting(F01.10) 1: AI 4: Panel potentiometer 5: Communication 6: PULSE input(DI4) 7: PID 8: Multi-reference 9: Simple PLC	0 (0 to 9)	Changeable only at stop
F01.05 (0x0105)	Auxiliary frequency source Y	0: Operating panel digital setting(F01.10) 1: AI 4: Panel potentiometer 5: Communication 6: PULSE input(DI4) 7: PID 8: Multi-reference 9: Simple PLC	0 (0 to 9)	Changeable only at stop
F01.06 (0x0106)	Base value of range of auxiliary frequency source Y	0: Relative to the maximum frequency 1: Relative to main frequency X reference	0 (0 to 1)	Changeable only at stop
F01.07 (0x0107)	Gain of auxiliary frequency source Y	This parameter defines gain of auxiliary frequency source Y.	100.0% (0.0 to 150.0%)	Changeable at any time

F01.08 (0x0108)	Frequency source superposition	<p>Ones: Frequency source selection</p> <p>0: Main frequency source X</p> <p>1: Main and auxiliary operation result (based on the tens)</p> <p>2: Switchover between main frequency source X and auxiliary frequency source Y</p> <p>3: Switchover between main frequency source X and main and auxiliary operation result</p> <p>4: Switchover between auxiliary frequency source Y and main and auxiliary operation result</p> <p>Tens: Main and auxiliary frequency source operation</p> <p>0: Main + Auxiliary</p> <p>1: Main – Auxiliary</p> <p>2: Max. (main, auxiliary)</p> <p>3: Min. (main, auxiliary)</p>	0 (00 to 34)	Changeable only at stop
F01.09 (0x0109)	Frequency source bound to the command source	<p>Ones: Frequency source bound to operating panel control</p> <p>Tens: Frequency source bound to terminal I/O control</p> <p>Hundreds: Frequency source bound to communication control</p> <p>0: No binding</p> <p>1: Operating panel digital setting(F01.10)</p> <p>2: AI</p> <p>5: Panel potentiometer</p> <p>6: Communication</p> <p>7: PULSE input(DI4)</p> <p>8: PID</p> <p>9: Multi-reference</p> <p>A: Simple PLC</p>	0x000 (0x000 to 0xAAA)	Changeable only at stop
F01.10 (0x010A)	Digital setting frequency	This parameter defines the Digital setting frequency.	50.00 Hz (0.00Hz to F01.11)	Changeable at any time
F01.11 (0x010B)	Maximum frequency	This parameter defines the maximum output frequency of the AC drive	50.00 Hz (50.00 to 599.00Hz)	Changeable only at stop
F01.12 (0x010C)	Source of frequency upper limit	<p>0: Operating panel numbers setting (F01.13)</p> <p>1: AI</p> <p>4: Operating panel potentiometer</p> <p>5: Communication</p> <p>6: Pulse-reference (DI4)</p>	0 (0 to 6)	Changeable only at stop
F01.13 (0x010D)	Frequency upper limit	This parameter defines the maximum running frequency allowed for the motor	50.00 Hz (F01.14 to F01.11)	Changeable only at stop
F01.14 (0x010E)	Frequency lower limit	This parameter defines the minimum running frequency for the motor	0.00 Hz (0.00Hz to F01.13)	Changeable only at stop
F01.15 (0x010F)	Frequency instruction resolution ratio	<p>1: 0.1Hz</p> <p>2: 0.01Hz</p> <p>Note: After changing this parameter, all parameters involving the frequency will be restored to the factory value, including the motor rated frequency .</p>	2 (1~2)	Changeable only at stop



F01.16 (0x0110)	Base frequency for UP/DOWN modification during running	0: Running frequency 1: Frequency reference	0 (0 to 1)	Changeable only at stop
F01.17 (0x0111)	Retention of digital setting of frequency	Ones: Stop retention selection 0: Non-retention 1: Retention Tens: Power down retention selection 0: Non-retention 1: Retention	0 (00 to 11)	Changeable at any time
F01.20 (0x0114)	Acceleration/Deceleration curve selection	0: Linear acceleration/deceleration 1: S-curve acceleration/deceleration	0 (0 to 1)	Changeable only at stop
F01.21 (0x0115)	Base value of the acceleration / deceleration	0: Relative to the maximum frequency 1: Relative to the setting frequency	0 (0 to 1)	Changeable only at stop
F01.22 (0x0116)	Acceleration time unit	0:1 s 1:0.1s	1 (0 to 1)	Changeable only at stop
F01.23 (0x0117)	Acceleration time 1	Acceleration time 1 of output frequency from 0.00Hz to F01.21	10.0 s (0.0s to 6000.0s)	Changeable at any time
F01.24 (0x0118)	Deceleration time 1	Deceleration time 1 of output frequency from F01.21 to 0.00Hz		Changeable at any time
F01.25 (0x0119)	Acceleration Time 2	Acceleration time 2 of output frequency from 0.00Hz to F01.21		Changeable at any time
F01.26 (0x011A)	Deceleration Time 2	Deceleration time 2 of output frequency from F01.21 to 0.00Hz		Changeable at any time
F01.27 (0x011B)	Acceleration Time 3	Acceleration time 3 of output frequency from 0.00Hz to F01.21		Changeable at any time
F01.28 (0x011C)	Deceleration time 3	Deceleration time 3 of output frequency from F01.21 to 0.00Hz		Changeable at any time
F01.29 (0x011D)	Acceleration time 4	Acceleration time 4 of output frequency from 0.00Hz to F01.21		Changeable at any time
F01.30 (0x011E)	Deceleration time 4	Deceleration time 4 of output frequency from F01.21 to 0.00Hz		Changeable at any time
F01.31 (0x011F)	Time proportion of S-curve acceleration start segment	This parameter defines the acceleration start S-curve time proportion	30.00% (0.0% to 100.0%-F01.32))	Changeable only at stop
F01.32 (0x0120)	Time proportion of S-curve acceleration end segment	This parameter defines the acceleration end S-curve time proportion	30.00% (0.0% to 100.0%-F01.31))	Changeable only at stop
F01.33 (0x0121)	Time proportion of S-curve deceleration start segment	This parameter defines the deceleration start S-curve time proportion	30.00% (0.0% to 100.0%-F01.34))	Changeable only at stop

F01.34 (0x0122)	Time proportion of S-curve deceleration end segment	This parameter defines the deceleration end S-curve time proportion	30.00% (0.0% to 100.0%-F01.33))	Changeable only at stop
F01.35 (0x0123)	Switching frequency between acceleration time 1 and acceleration time 2	This parameter defines the switching frequency between acceleration time 1 and acceleration time 2	0.00 Hz (0.00Hz to F01.11)	Changeable at any time
F01.36 (0x0124)	Switching frequency between deceleration time 1 and acceleration time 2	This parameter defines the switching frequency between deceleration time 1 with deceleration time 2	0.00 Hz (0.00Hz to F01.11)	Changeable at any time
F01.40 (0x0128)	Carrier frequency	This parameter defines the switching frequency of the IGBT	6.0KHZ	Changeable only at stop
F01.41 (0x0129)	Carrier automatic update basis	Ones: Adjust with temperature 0: Does not adjust with the temperature 1: Adjust with the temperature Tens: Adjust with frequency (VF control only) 0: Does not adjust with frequency 1: Adjust with frequency	11 (00 to 11)	Changeable at any time

7.5 Group F02: Start/Stop Control Parameters

Parameter (address)	Name	Reference	Default (Setup range)	Adjustable properties
F02.00 (0x0200)	Startup mode	0: Direct start 1: Pre-excitation start 2: Speed tracking start	0 (0 to 2)	Changeable at any time
F02.01 (0x0201)	Startup frequency	This parameter defines the output startup frequency	0.00 Hz (0.00Hz to 20.00Hz)	Changeable at any time
F02.02 (0x0202)	Startup frequency hold time	This parameter defines the start frequency hold time for the output	0.0 s (0.0s to 100.0s)	Changeable only at stop
F02.03 (0x0203)	DC braking current at startup	This parameter defines the DC braking current for starting	0% (0% to 150%)	Changeable only at stop
F02.04 (0x0204)	DC braking time at startup	This parameter defines the DC braking time for starting	0.0 s (0.0s to 100.0s)	Changeable only at stop
F02.07 (0x0207)	Rotation direction	0: Same 1: Opposite	0 (0 to 1)	Changeable only at stop
F02.08 (0x0208)	Startup protection	0: Not protected 1: Protected	0 (0 to 1)	Changeable only at stop
F02.10 (0x020A)	Speed tracking mode	Ones: Speed tracking search method 0: From the stop frequency 1: From 50Hz 2: From the maximum frequency	0 (0 ~ 2)	Changeable only at stop
F02.11 (0x020B)	Demagnetization time	After the motor stops, there is residual magnetism. You need to wait for this time before starting again	0.00s (0.00s ~ 9.99s)	Changeable at any time

F02.12 (0x020C)	Speed tracking current	This parameter defines the value of speed tracking current	100% (20% ~ 200%)	Changeable at any time
F02.13 (0x020D)	Speed tracking time	This parameter defines the value of speed tracking time	30 (1 ~ 200)	Changeable at any time
F02.14 (0x020E)	Speed tracking current loop KP	This parameter defines the proportional gain of the speed tracking current loop	500 (0 ~ 2000)	Changeable at any time
F02.15 (0x020F)	Speed tracking current loop KI	This parameter defines the integral coefficient of the speed tracking current loop	500 (0 ~ 2000)	Changeable at any time
F02.20 (0x0214)	Stop mode	0: Decelerate to stop 1: Coast to stop	0 (0 to 1)	Changeable at any time
F02.23 (0x0217)	Start frequency of DC braking at stop	The AC drive starts DC braking when the running frequency decreases to the value of this parameter during deceleration to stop	0.00 Hz (0.00Hz to F01.11)	Changeable at any time
F02.24 (0x0218)	DC braking delay at stop	When the running frequency decreases to the start frequency of DC braking at stop, the AC drive stops output and starts DC braking after this waiting time.	0.0 s (0.0s to 100.0s)	Changeable at any time
F02.25 (0x0219)	DC braking current at stop	This parameter defines the stopping DC braking current, a larger DC braking current indicates stronger braking force	0% (0-150%)	Changeable at any time
F02.26 (0x021A)	Stop DC braking time	This parameter defines the shutdown DC brake hold time	0.0 s (0.0s to 100.0s)	Changeable at any time
F02.27 (0x021B)	FWD/REV switchover dead zone time	This parameter defines the transition time at 0 Hz output during transition between forward running and reverse running	0.0 s (0.0s to 60000.0s)	
F02.28 (0x021C)	Reverse frequency inhibition	0: Disabled 1: Enabled	0 (0 to 1)	Changeable only at stop
F02.29 (0x021D)	Action to take when frequency is below lower limit	0: Run at frequency lower limit 1: Stop in F02.20 mode 2: Run at zero speed	0 (0 to 2)	Changeable at any time
F02.30 (0x021E)	Jog frequency	This parameter defines the running frequency of the AC drive in jogging mode	5.00 Hz (0.00Hz to F01.11)	Changeable at any time
F02.31 (0x021F)	Jog acceleration time	This parameter defines the acceleration time of the AC drive in jogging mode	10.0 s (0.1s to 6000.0s)	Changeable at any time
F02.32 (0x0220)	Jog deceleration time	This parameter defines the deceleration time of the AC drive in jogging mode	10.0 s (0.1s to 6000.0s)	Changeable at any time
F02.33 (0x0221)	Jog acceleration/deceleration curve selection	0: Linear 1: S-curve	0 (0 to 1)	Changeable only at stop



F02.35 (0x0223)	Jog preferred	0: OFF Jog preferred 1: Jog preferred	0 (0 to 1)	Changeable at any time
F02.36 (0x0224)	Skip frequency enable during acceleration/deceleration	0: Disabled 1: Enabled	0 (0 to 1)	Changeable at any time
F02.37 (0x0225)	Skip frequency 1	This parameter defines the first skip frequency.	0.00 Hz (0.00Hz to F00.11)	Changeable at any time
F02.38 (0x0226)	Skip frequency band 1	This parameter defines the skip frequency band 1.	0.00 Hz (0.00Hz to 5.00Hz)	Changeable at any time
F02.39 (0x0227)	Skip frequency 2	This parameter defines the second skip frequency.	0.00 Hz (0.00Hz to F00.11)	Changeable at any time
F02.40 (0x0228)	Skip frequency band 2	This parameter defines the skip frequency band 2.	0.00 Hz (0.00Hz to 5.00Hz)	Changeable at any time

7.6 Group F03: Motor Parameters

Parameter (address)	Name	Reference	Default (Setup range)	Adjustable properties
F03.02 (0x0302)	Rated motor power	This parameter defines the rated power of the motor	Model-based setting (0.1kW to 15.0kW)	Changeable only at stop
F03.03 (0x0303)	Rated motor voltage	This parameter defines the rated voltage of the motor	Model-based setting (1V to 500V)	Changeable only at stop
F03.04 (0x0304)	Rated motor current	This parameter defines the rated current of the motor	Model-based setting (0.01A to 100.00A)	Changeable only at stop
F03.05 (0x0305)	Rated motor frequency	This parameter defines the rated frequency of the motor	Model-based setting (0.01Hz to F01.11)	Changeable only at stop
F03.06 (0x0306)	Rated motor speed	This parameter defines the rated speed of the motor	Model-based setting (1 to 65,535rpm)	Changeable only at stop
F03.09 (0x0309)	Motor parameters auto-tuning	0: No operation 1: Static auto-tuning for asynchronous motor (some parameters) 2: Rotating auto-tuning for asynchronous motor (all parameters)	0 (0 to 2)	Changeable only at stop
F03.10 (0x030A)	Asynchronous motor stator resistance	This parameter defines the DC resistance of the asynchronous motor stator winding	Model-based setting (0.0001 to 655.35Ω)	Changeable only at stop
F03.11 (0x030B)	Asynchronous motor rotor resistance	This parameter defines the DC resistance of the asynchronous motor rotor winding	Model-based setting (0.0001 to 655.35Ω)	Changeable only at stop
F03.12 (0x030C)	Asynchronous motor leakage inductance	This parameter defines the asynchronous motor leakage inductance	Model-based setting (0.001 to 655.35mH)	Changeable only at stop
F03.13 (0x030D)	Asynchronous motor mutual inductance	This parameter defines the asynchronous motor mutual inductance	Model-based setting (0.01-6553.5mH)	Changeable only at stop

F03.14 (0x030E)	Asynchronous motor no-load current	This parameter defines the current passing through the three-phase stator winding of an asynchronous motor during no-load operation	Model-based setting (0.1A to F03.04)	Changeable only at stop
--------------------	------------------------------------	---	---	-------------------------

7.7 Group F05: V/f Control Parameters

Parameter (address)	Name	Reference	Default (Setup range)	Adjustable properties
F05.00 (0x0500)	V/f curve	0: Linear V/f curve 1: Custom V/f curve 2: 1.2 power V/f curve 4: 1.4 power V/f curve 6: 1.6 power V/f curve 8: 1.8 power V/f curve 10: Square V/f curve 11: V/f full separation mode 12: V/f half separation pattern	0 (00 to 12)	Changeable only at stop
F05.01 (0x0501)	Multi-point V/f voltage V1	This parameter defines the multi-point V/f voltage V1	0.0% (0.0% to 100.0%)	Changeable only at stop
F05.02 (0x0502)	Multi-point V/f frequency F1	This parameter defines the multi-point V/f frequency F1	0.00 Hz (0.00Hz to F05.04)	Changeable only at stop
F05.03 (0x0503)	Multi-point V/f voltage V2	This parameter defines the multi-point V/f voltage V2	0.0% (0.0% to 100.0%)	Changeable only at stop
F05.04 (0x0504)	Multi-point V/f frequency F2	This parameter defines the multi-point V/f frequency F2	0.00 Hz (0.00Hz to F05.06)	Changeable only at stop
F05.05 (0x0505)	Multi-point V/f voltage V3	This parameter defines the multi-point V/f voltage V3	0.0% (0.0% to 100.0%)	Changeable only at stop
F05.06 (0x0506)	Multi-point V/f frequency F3	This parameter defines the multi-point V/f frequency F3	0.00 Hz (F05.04 to F01.11)	Changeable only at stop
F05.07 (0x0507)	Torque boost	Under low frequency conditions, by setting this parameter to increase the output voltage of the frequency converter, the current is increased to improve the output torque (0.0%:Automatic torque boost)	3.0% (0.0%~30.0%)	Changeable at any time
F05.08 (0x0508)	Cut-off frequency of torque boost	This parameter defines the effective range of the torque boost function. When the output frequency exceeds this value, the torque boost function is terminated.	20.00 Hz (0.00Hz to F01.11)	Changeable only at stop
F05.09 (0x0509)	Slip compensation gain	This parameter defines the slip compensation gain	100.0% (0.0% to 200.0%)	Changeable at any time
F05.10 (0x050A)	Slip compensation limit	This parameter defines the slip compensation limit value (rated slip)	200.0% (0.0% to 200.0%)	Changeable at any time

F05.11 (0x050B)	Slip compensation filter time	The slip compensation function requires correct input of motor nameplate parameters and parameter auto-tuning to achieve the best results	0.100 s (0.000 to 1.000s)	Changeable at any time
F05.12 (0x050C)	Online torque compensation gain 1	This parameter defines the online torque compensation gain 1	130 (100 to 150)	Changeable at any time
F05.13 (0x050D)	Online torque compensation gain 2	This parameter defines the online torque compensation gain 2	100 (50 to 150)	Changeable at any time
F05.14 (0x050E)	Over-excitation gain	This parameter defines the over-excitation gain, the larger the gain, the stronger the suppression effect	100 (0 to 200)	Changeable at any time
F05.15 (0x050F)	Oscillation suppression mode	0: Invalid 1 to 4: Mode 1 to 4	1 (0 to 4)	Changeable at any time
F05.16 (0x0510)	Oscillation suppression gain	By adjusting this value, low frequency resonance can be suppressed, but it can't be too large, otherwise it will cause additional stability problems	40 (0 to 200)	Changeable at any time
F05.20 (0x0514)	Voltage source for V/f separated	0: Digital setting (F05.21) 1: AI 4: Operating panel potentiometer 5: Communication 6: Pulse-reference (DI4) 7: PID setting 8: Multi-reference 9: Simple PLC	0 (0 to 9)	Changeable at any time
F05.21 (0x0515)	V/f separation voltage	This parameter defines the V/f separation output voltage	0V (0V to F03.03)	Changeable at any time
F05.22 (0x0516)	Voltage acceleration time of V/f separation	This parameter defines the V/f separation voltage acceleration time	0.0 s (0.0s to 1000.0s)	Changeable at any time
F05.23 (0x0517)	Voltage deceleration time of V/f separation	This parameter defines the V/f separation voltage deceleration time	0.0 s (0.0s to 1000.0s)	Changeable at any time
F05.24 (0x0518)	Stop mode of V/f separation	0: Frequency and voltage decline to 0 independently 1: The frequency declines to 0 after voltage declines to 0	0 (0 to 1)	Changeable only at stop
F05.30 (0x051E)	VF energy saving control	0: disables energy saving control 1: Automatic energy saving control 2: Manual energy saving control The load changes frequently. Use energy saving control with caution	0 (0 to 2)	Changeable only at stop

F05.31 (0x051F)	VF energy saving coefficient	Manual energy-saving control, set the energy-saving control coefficient, the smaller the value, the more obvious the energy-saving effect, but the sudden load speed drop will be larger	50.0% (20.0% to 100.0%)	Changeable at any time
F05.32 (0x0520)	VF Energy saving control KP	Set the proportional gain of VF energy saving control voltage regulation	500 (0 to 2000)	Changeable at any time
F05.33 (0x0521)	VF Energy saving control KI	Set the integral coefficient of VF energy saving control voltage regulation	800 (0 to 2000)	Changeable at any time

7.8 Group F06: Speed Loop and Torque Control Parameters

Parameter (address)	Name	Reference	Default (Setup range)	Adjustable properties
F06.00 (0x0600)	Low speed loop proportional gain	This parameter defines the low speed loop proportional gain	60 (1 to 500)	Changeable at any time
F06.01 (0x0601)	Low speed loop integration time	This parameter defines low speed loop integration time	0.20 s (0.01s to 5.00s)	Changeable at any times
F06.02 (0x0602)	High speed loop proportional gain	This parameter defines the high speed loop proportional gain	30 (1 to 500)	Changeable at any time
F06.03 (0x0603)	High speed loop integration time	This parameter defines the high speed loop integration time	0.50 s (0.01s to 5.00s)	Changeable at any time
F06.04 (0x0604)	Switchover frequency 1	This parameter defines the switchover frequency 1 of the speed loop	5.00 Hz (0.00Hz to F06.05)	Changeable at any time
F06.05 (0x0605)	Switchover frequency 2	This parameter defines the switchover frequency 2 of the speed loop	10.00 Hz (F06.04 to F01.11)	Changes in real time
F06.06 (0x0606)	Slip compensation gain	This parameter defines the slip compensation gain of vector control	100% (50% to 200%)	Changeable at any time
F06.07 (0x0607)	Speed feedback filter time	This parameter defines the speed feedback filter time	15ms (5 to 100ms)	Changeable at any time
F06.08 (0x0608)	Speed loop integral separation	0: No separation 1: Integral separation	0 (0 to 1)	Changeable only at stop
F06.10 (0x060A)	Torque Lock Selection under Speed Control	0: No lock 1: Motor generation torque is locked to the F06.11 setting channel	0 (0 to 1)	Changeable only at stop
F06.11 (0x060B)	Torque upper limit source in speed control mode (motoring)	0: Digital setting (F06.12) 1: AI 4: Operating panel potentiometer 5: Communication 6: Pulse-reference (DI4)	0 (0 to 6)	Changeable only at stop

F06.12 (0x060C)	Torque upper limit in speed control mode (motoring)	This parameter defines torque limit in Speed control mode (electric)	180.0% (0.0% to 300.0%)	Changeable at any time
F06.13 (0x060D)	Torque upper limit source in speed control mode (generating)	0: Digital setting (F06.14) 1: AI 4: Operating panel potentiometer 5: Communication 6: Pulse-reference (DI4)	0 (0 to 6)	Changeable only at stop
F06.14 (0x060E)	Torque upper limit in speed control mode (generating)	This parameter defines torque limit in speed control mode (generation)	180.0% (0.0% to 300.0%)	Changeable at any time

7.9 Group F07: Current Loop and Flux Control Parameters

Parameter (address)	Name	Reference	Default (Setup range)	Adjustable properties
F07.00 (0x0700)	Current loop excitation shaft proportional gain	This parameter defines the current loop excitation shaft proportional gain	2000 (0 to 60,000)	Changeable at any time
F07.01 (0x0701)	Current loop excitation shaft integral gain	This parameter defines the current loop excitation shaft integral gain	1000 (0 to 60,000)	Changeable at any time
F07.02 (0x0702)	Current loop torque shaft proportional gain	This parameter defines the current loop torque shaft proportional gain	2000 (0 to 60,000)	Changeable at any time
F07.03 (0x0703)	Current loop torque shaft integral gain	This parameter defines the current loop torque shaft integral gain	1000 (0 to 60,000)	Changeable at any time

7.10 Group F08: Terminal DI Function Parameters

Parameter (address)	Name	Reference	Default (Setup range)	Adjustable properties
F08.00 (0x0800)	DI1 function	0:No function 1:Forward running (FWD)	1 (0 to 52)	Changeable only at stop
F08.01 (0x0801)	DI2 function	2:Reverse operation (REV) 3:Three-wire operation control	2 (0 to 52)	Changeable only at stop
F08.02 (0x0802)	DI3 function	4:Forward jog 5:Reverse jog 6:Free stop	0 (0 to 52)	Changeable only at stop
F08.03 (0x0803)	DI4 function	7:Emergency stop 8:Command channel local and remote switching 9:Command channel terminal and communication switching 10:External stop terminal 12:Immediate DC braking	0 (0 to 52)	Changeable only at stop



		<p>13:Deceleration DC braking 14:Run pause 15:Inversion prohibited 16:Fault reset (RESET) 17:External fault normally open input 18:External fault normally closed input 19:User defined fault 21:Multi-speed command terminal 1 22:Multi-speed command terminal 2 23:Multi-speed command terminal 3 25:Terminal UP 26:Terminal DOWN 27:UP/DOWN setting clear (terminal, keyboard) 28:Channel X switches to channel Y 29:Frequency source X and initial frequency switching 30:Frequency source Y and initial frequency switching 31:Frequency modification enabled 32:Acceleration and deceleration time selection terminal 1 33:Acceleration and deceleration time selection terminal 2 34:Acceleration and deceleration pause 35:PID points suspended 36:PID pause 37:PID parameter switching 38:PID action direction is reversed 39:PLC status reset 43: Counter input (DI4) 44: Counter reset 47: High-speed pulse input(DI4) 51:This running time is cleared to zero 52:Fire mode enable</p>		
F08.10 (0x080A)	Terminal control mode	<p>0: Two-wire mode 1 1: Two-wire mode 2 2: Three-wire mode 1 3: Three-wire mode 2</p>	0 (0 to 3)	Changeable only at stop
F08.11 (0x080B)	Terminal UP/DN change rate	This parameter defines the terminal UP/DN change rate	1.000 Hz/s (0.001Hz/s to 50.000Hz/s)	Changeable at any time



F08.13 (0x080D)	Terminal emergency stop deceleration time	This parameter defines the terminal emergency stop deceleration time	1.0 s (0.0s to 6000.0s)	Changeable only at stop
F08.14 (0x080E)	DI1 to DI4 terminal characteristics	Ones: DI1 setting Tens: DI2 setting Hundreds: DI3 setting Thousands: DI4 setting 0: Active close 1: Active open	0000 (0000 to 1111)	Live changes
F08.20 (0x0814)	Minimum pulse input frequency	This parameter defines Minimum pulse input frequency.	0.00 kHz (0.00kHz to F08.22)	Changeable at any time
F08.21 (0x0815)	Percentage corresponding to minimum pulse input frequency	This parameter defines the Percentage corresponding.	0.0% (-100.0% to 100.0%)	Changeable at any time
F08.22 (0x0816)	Maximum pulse input frequency	This parameter defines Maximum pulse input frequency.	50.00 kHz (F08.20 to 50.00kHz)	Changeable at any time
F08.23 (0x0817)	Percentage corresponding to maximum pulse input frequency	This parameter defines the Percentage corresponding.	100.0% (-100.0% to 100.0%)	Changeable at any time
F08.24 (0x0818)	Pulse filter time	This parameter defines Pulse filter time.	0.10 s (0.00s to 10.00s)	Changeable at any time
F08.30 (0x081E)	DI1 filter time	This parameter defines the DI1 filter time	0.010 s (0.000s to 1.000s)	Changeable at any times
F08.31 (0x081F)	DI2 filter time	This parameter defines the DI2 filter time	0.010 s (0.000s to 1.000s)	Changeable at any times
F08.32 (0x0820)	DI3 filter time	This parameter defines the DI3 filter time	0.010 s (0.000s to 1.000s)	Changeable at any times
F08.33 (0x0821)	DI4 filter time	This parameter defines the DI4 filter time	0.010 s (0.000s to 1.000s)	Changeable at any times
F08.40 (0x0828)	DI1 Delay time	This parameter defines the DI1 delay time	0.0 s (0.0 to 600.0s)	Changeable at any time
F08.41 (0x0829)	DI2 delay time	This parameter defines the DI2 delay time	0.0 s (0.0 to 600.0s)	Changeable at any time
F08.42 (0x082A)	DI3 delay time	This parameter defines the DI3 delay time	0.0 s (0.0 to 600.0s)	Changeable at any time
F08.43 (0x082B)	DI4 Delay time	This parameter defines the DI4 delay time	0.0 s (0.0 to 600.0s)	Changeable at any time

7.11 Group F09: Terminal AI Function Parameters

Parameter (address)	Name	Reference	Default (Setup range)	Adjustable properties
F09.02 (0x0902)	Filter time of AI	This parameter defines the filter time of the analog signal to be filtered to eliminate interference signals.	0.10 s (0.00s to 10.00s)	Changeable at any time
F09.11 (0x090B)	Filter time of the panel potentiometer	This parameter defines the filter time of the analog signal to be filtered to eliminate interference signals.	0.10 s (0.00s to 10.00s)	Changeable at any time
F09.12 (0x090C)	AI up and down limit truncation value	Set the upper and lower limit of the AI terminal	0.0% (0.0% to 20.0%)	Changeable at any time

F09.13 (0x090D)	AI upper and lower limit truncation selection	Ones: AI Thousands: Panel Potentiometer 0: Not truncate 1: Truncate	0 (0000 to 1001)	Changeable at any time
F09.20 (0x0914)	AI curve selection	Ones: AI Thousands: Panel Potentiometer 1: Curve 1 2: Curve 2	0X2111 (0X1111 to 0X2112)	Changeable at any time
F09.21 (0x0915)	Minimum input of AI curve 1	This parameter defines Minimum input of AI curve 1, Voltage signals below this value are treated as the minimum value.	0.00 V (0.00 to F09.23)	Changeable at any time
F09.22 (0x0916)	Percentage corresponding to minimum input of AI curve 1	This parameter defines the Percentage corresponding.	0.0% (-100.0% to 100.0%)	Changeable at any time
F09.23 (0x0917)	Maximum input of AI curve 1	This parameter defines Maximum input of AI curve 1, Voltage signals higher than this value are treated as the maximum value.	10.00 V (F09.21 to 10.00V)	Changeable at any time
F09.24 (0x0918)	Percentage corresponding to maximum input of AI curve 1	This parameter defines the Percentage corresponding.	100.0% (-100.0% to 100.0%)	Changeable at any time
F09.25 (0x0919)	Minimum input of AI curve 2	This parameter defines Minimum input of AI curve 2, Voltage signals below this value are treated as the minimum value.	0.00 V (0.00V to F09.27)	Changeable at any time
F09.26 (0x091A)	Percentage corresponding to minimum input of AI curve 2	This parameter defines the Percentage corresponding.	0.0% (-100.0% to 100.0%)	Changeable at any time
F09.27 (0x091B)	Maximum input of AI curve 2	This parameter defines Minimum input of AI curve 2, Voltage signals higher than this value are treated as the maximum value.	10.00 V (F09.25 to 10.00V)	Changeable at any time
F09.28 (0x091C)	Percentage corresponding to maximum input of AI curve 2	This parameter defines the Percentage corresponding.	100.0% (-100.0% to 100.0%)	Changeable at any time

7.12 Group F10: Terminal DO Function Parameters

Parameter (address)	Name	Reference	Default (Setup range)	Adjustable properties
F10.01 (0x0A01)	DO terminal function	0:No output 1:Ready to run 2:The inverter is running 3:The frequency converter is running forward 4:The inverter is running in reverse rotation 5:The inverter is running at zero speed (stop is invalid) 6:The inverter is running at zero speed (valid when stopped) 7:Zero current state 8:Frequency converter fault output 9:Frequency converter alarm output 11:Motor overload warning	2 (0 to 37)	Changeable at any time
F10.02 (0x0A02)	RELAY function	12:Frequency converter overload warning 13:Frequency converter load loss	8 (0 to 37)	Changeable at any time

		14: Undervoltage status output 15: Frequency level detection FDT1 output 16: Frequency level detection FDT2 output 17: Frequency arrival 19: Torque is limited 20: Upper limit frequency reached 21: Lower limit frequency reached (running state) 22: Any frequency reaches the output 23: Any current reaches the output 24: Communication settings 25: Set count value reached 26: The specified count value is reached 29: The module temperature reaches 30: Output current exceeds limit 31: PLC cycle completed 32: Timing to reach output 33: This running time arrives 34: Accumulated running time reached 35: Accumulated power-on time reached 36: Fire mode enable mark 37: Shutdown fault detection sign		
F10.05 (0x0A05)	DO2 output terminal select	0: Digital output 1: Pulse output (F11.02 select output function)	0 (0 to 1)	Changeable at any time
F10.06 (0x0A06)	Output terminal active mode	Ones: Reserved Tens: Control board DO 0: Positive logic active 1: Negative logic active Hundreds: Control board Relay 0: Positive logic active 1: Negative logic active	000 (000 to 110)	Live changes
F10.11 (0x0A0B)	DO output delay	This parameter defines the DO output ON delay time.	0.0 s (0.0s to 3600.0s)	Changeable at any time
F10.12 (0x0A0C)	RELAY output delay	This parameter defines the RELAY output ON delay time.	0.0 s (0.0s to 3600.0s)	Changeable at any time
F10.20 (0x0A14)	Frequency detection value (FDT1)	This parameter defines Frequency detection value 1	5.00 Hz (0.00Hz to F01.11)	Changeable at any time
F10.21 (0x0A15)	Frequency Detection hysteresis (FDT1)	This parameter defines frequency detection range 1	0.0% (0.0% to 100.0%)	Changeable at any time
F10.22 (0x0A16)	Frequency detection value (FDT2)	This parameter defines the frequency detection value 2	5.00 Hz (0.00Hz to F01.11)	Changeable at any time
F10.23 (0x0A17)	Frequency Detection hysteresis (FDT2)	This parameter defines frequency detection range 2	0.0% (0.0% to 100.0%)	Changeable at any time



F10.24 (0x0A18)	Frequency reach detection range	This parameter defines frequency reach detection range	0.0% (0.0% to 100.0%)	Changeable at any time
F10.25 (0x0A19)	Any frequency reach detection value	This parameter defines the arbitrary arrival frequency detection value	50.00 Hz (0.00Hz to F01.11)	Changeable at any time
F10.26 (0x0A1A)	Any frequency reach detection range	This parameter defines an arbitrary arrival frequency detection range	0.0% (0.0% to 100.0%)	Changeable at any time
F10.29 (0x0A1D)	Zero current detection level	This parameter defines the zero current detection threshold	5.0% (0.0% to 300.0%)	Changeable at any time
F10.30 (0x0A1E)	Zero current detection delay	This parameter defines the zero current detection delay time	0.10 s (0.01 to 60.00)	Changeable at any time
F10.31 (0x0A1F)	Output overcurrent threshold	This parameter defines the output current overlimit	200.0% (0.0% to 300.0%)	Changeable at any time
F10.32 (0x0A20)	Output overcurrent detection delay	This parameter defines the detection delay time	0.01 s (0.00 to 60.00)	Changeable at any time
F10.33 (0x0A21)	Detection level of current	This parameter defines arbitrary arrival current percentage	100.0% (0.0% to 300.0%)	Changeable at any time
F10.34 (0x0A22)	Detection width of current	This parameter defines the arbitrary arrival current width	0.0% (0.0% to 300.0%)	Changeable at any time
F10.35 (0x0A23)	IGBT temperature reach	This parameter defines IGBT temperature reach value	90 °C (0 °C to 100 °C)	Changeable at any time

7.13Group F11: AO Terminal Function Parameters

Parameter (address)	Name	Reference	Default (Setup range)	Adjustable properties
F11.00 (0x0B00)	AO function	0: No function 1: Output frequency (0 - maximum output frequency) 2: Setting frequency (0 - maximum output frequency) 3: Motor speed (0 - speed corresponding to maximum output frequency)	1 (0 to 21)	Changeable at any time
F11.02 (0x0B02)	High speed pulse output feature selection	4: Output current (0 - 2 times of rated AC driver current) 5: Output current (0 - 2 times of rated motor current) 6: Output voltage (0 - 1.2 times of rated AC driver voltage) 7: Setting torque (0 - 2 times of rated motor torque) 8: Output torque (0 - 2 times of	0 (0 to 21)	Changeable at any time

		rated motor torque) 9: Output torque (0 - 2 times of rated AC driver torque, with direction) 10: Output torque (0 - rated AC driver torque, with direction) 12: DC bus voltage (0 - 2.2 times of rated AC driver voltage) 13: Output power (0 - 2 times of rated motor power) 15: High-speed PULSE input 17: Counter 18: Communication 19: PID settings 20: PID feedback 21: AI input		
F11.05 (0x0B05)	Maximum output frequency of high-speed pulse	This parameter defines the upper limit of the high speed pulse	50.00 kHz (0.01kHz to 50.00kHz)	Changeable at any time
F11.10 (0x0B0A)	AO gain	Adjust the value of the analog output of the terminal	1.00 (-10.00 to 10.00)	Changeable at any time
F11.11 (0x0B0B)	AO zero offset	This parameter defines the AO output offset, which adjust the zero point of the terminal output	0.0% (-100.0% to 100.0%)	Changeable at any time

7.14 Group F12: Auxiliary Function Parameters

Parameter (address)	Name	Reference	Default (Setup range)	Adjustable properties
F12.00 (0x0C00)	Wakeup frequency	This parameter defines wakeup frequency	0.00 Hz (F12.02 to F01.11)	Changeable at any time
F12.01 (0x0C01)	Wakeup delay	This parameter defines wakeup delay time	0.0 s (0.0s to 6500.0s)	Changeable at any time
F12.02 (0x0C02)	Hibernation frequency	This parameter defines hibernation frequency	0.00 Hz (0Hz to F12.00)	Changeable at any time
F12.03 (0x0C03)	Hibernation delay	This parameter defines hibernation delay time	0.0 s (0s to 6500.0s)	Changeable at any time
F12.07 (0x0C07)	Droop control	Control load balance	0.00 Hz (0.00 to 10.00Hz)	Changeable at any time
F12.08 (0x0C08)	Cooling fan control	0: Working during AC drive running 1: Working always 2: Working automatically controlled according to temperature rise	0 (0 to 2)	Changeable at any time
F12.09 (0x0C09)	Output power correction coefficient	This parameter defines the output power correction ratio	100.0% (0.0% to 200.0%)	Changeable only at stop
F12.10 (0x0C0A)	Reference count value	This parameter defines the maximum counter value	10000 (1 to 65535)	Changeable at any time
F12.11 (0x0C0B)	Designated count value	This parameter defines the current counter value	10000 (1 to 65535)	Changeable at any time
F12.30 (0x0C1E)	Timing duration	This parameter defines the time you need to run	0min (0min to 6500.0min)	Changeable only at stop

F12.31 (0x0C1F)	Current running duration threshold	This parameter defines the current running duration threshold	0 min (0min to 6500.0min)	Changeable at any time
F12.32 (0x0C20)	Running duration threshold	This parameter defines the accumulative running duration reached	0h (0h to 65000h)	Changeable at any time
F12.33 (0x0C21)	Power-on duration threshold	This parameter defines the accumulative power-on duration reached	0h (0h to 65000h)	Changeable at any time
F12.34 (0x0C22)	Timed running time unit	0: min 1: s	0 (0~1)	Changeable at any time

7.15Group F13: Protection Parameters

Parameter (address)	Name	Reference	Default (Setup range)	Adjustable properties
F13.00 (0x0D00)	Overcurrent stall suppression	0: Disabled 1: Enabled	1 (0 to 1)	Changeable only at stop
F13.01 (0x0D01)	Overcurrent stall suppression action current	This parameter defines the percentage of overcurrent stall suppression action current threshold	150.0% (50% to 200%)	Changeable only at stop
F13.02 (0x0D02)	Overcurrent stall suppression gain	This parameter defines the gain of overcurrent stall suppression response	50 (0 to 100)	Changeable at any time
F13.03 (0x0D03)	Compensation coefficient of speed multiplying overcurrent stall suppression action current	Reduce the high-speed overcurrent stall suppression action current threshold	50 (50 to 200)	Changeable only at stop
F13.04 (0x0D04)	Current protection Settings	Pulse-by-pulse current limit protection 0: Disabled 1: Enabled	1 (0 to 1)	Changeable only at stop
F13.07 (0x0D07)	Software overcurrent threshold	When the output current of the AC drive is higher than F13.07 (software overcurrent threshold)	220.0% (0.0% to 250%)	Changeable at any time
F13.08 (0x0D08)	Output overcurrent detection delay	For a period longer than the time defined by F13.08 (output overcurrent detection delay), the DO terminal outputs an active signal	0.01 s (0.00 to 6.00s)	Changeable at any time
F13.10 (0x0D0A)	Overvoltage stall suppression	0: Disabled 1: Enabled	1 (0 to 1)	Changeable only at stop
F13.11 (0x0D0B)	Overvoltage stall suppression action voltage	This parameter defines the V/f overvoltage stall suppression action voltage threshold	220V model: 380.0V 380V model: 750.0V 440V model: 770.0V (200.0V to 820.0V)	Changeable only at stop
F13.12 (0x0D0C)	Overvoltage stall suppression frequency gain	Increase this value will improve the control effect of the bus voltage, but the output frequency will fluctuate	50 (0 to 100)	Changeable at any time
F13.13 (0x0D0D)	Overvoltage stall suppresses voltage gain	Suppress the bus voltage and increase this setting value can reduce the bus voltage overshoot	50 (0 to 100)	Changeable at any time

F13.14 (0x0D0E)	Frequency rise threshold for overvoltage stall suppression	Overvoltage stall suppression may increase the operating frequency. This parameter is the incremental upper limit of the operating frequency	5.00 Hz (0 to 50.00Hz)	Changeable only at stop
F13.15 (0x0D0F)	Generating power limiting	0: Disabled 1: Enabled	0 (0 to 1)	Changeable only at stop
F13.16 (0x0D10)	Generating power upper limit	This parameter defines the generation power upper limit	20.0% (0.0 to 200.0%)	Changeable only at stop
F13.17 (0x0D11)	Start voltage for actuating braking unit	The start voltage for actuating braking unit, used to adjust the brake resistance energy consumption efficiency	220V model: 360.0V 380V model: 700.0V 440V model: 750.0V (200.0V to 820.0V)	Changeable at any time
F13.18 (0x0D12)	Braking unit usage	This parameter defines the usage rate of the braking unit	100.0% (0.0% to 100.0%)	Changeable only at stop
F13.19 (0x0D13)	Overvoltage threshold	This parameter defines the bus overvoltage threshold	220V model: 400.0V 380V model: 820.0V 440V model: 820.0V (350.0V to 820.0V)	Changeable at any time
F13.20 (0x0D14)	Power dip ride-through	This parameter defines whether the AC driver runs during instantaneous power failure 0: Disabled 1: Keep bus voltage constant 2: Decelerate to stop	0 (0 to 2)	Changeable only at stop
F13.21 (0x0D15)	Voltage threshold for disabling power dip ride-through	This parameter defines the voltage threshold for disabling power dip ride-through of the AC driver, if voltage higher than this value, temporarily stop the adjustment	85.0% (80.0% to 100.0%)	Changeable at any time
F13.22 (0x0D16)	Voltage threshold for enabling power dip ride-through	This parameter defines the voltage level at which the bus voltage is maintained upon power failure. Upon power failure, the bus voltage is maintained around F13.22 (voltage threshold for enabling power dip ride-through)	80.0% (60.0% to 100.0%)	Changeable at any time
F13.23 (0x0D17)	Delay of voltage recovery from power dip	This parameter defines the time required for the bus voltage to rise from F13.21 (voltage threshold for disabling power dip ride-through) to the voltage before power failure	0.5 s (0.0s to 100.0s)	Changeable at any time
F13.24 (0x0D18)	Power dip ride-through gain Kp	This parameter is valid only in the "keep bus voltage constant" mode (F13.20 = 1).	50 (0 to 100)	Changeable at any time
F13.25 (0x0D19)	Power dip ride-through integral coefficient	If undervoltage occurs frequently during power dip ride-through, increase the power dip ride-through gain and integral coefficient	30 (0 to 100)	Changeable at any time
F13.26 (0x0D1A)	Deceleration time of power dip ride-through	This parameter is valid only in the "decelerate to stop" mode (F13.20 = 2). When the bus voltage is lower than the value of F13.22, the AC drive decelerates to stop. The deceleration time is determined by this parameter but not F	20.0 s (0.0s to 300.0s)	Changeable at any time

F13.29 (0x0D1D)	Undervoltage threshold	When the bus voltage falls below the setpoint of F13.29, the AC driver reports a fault	220V model: 200.0V 380V model: 350.0V 440V model: 350.0V (150.0V to 700.0V)	Changeable at any time
F13.33 (0x0D21)	Software short-to-ground detection	Ones: Short-to-ground detection upon power-on Tens: Short-to-ground detection before running 0: Disabled 1: Enabled	00 (00 to 11)	Changeable only at stop
F13.34 (0x0D22)	Input phase loss protection	0: Disabled 1: Enabled	1 (0 to 1)	Changeable at any time
F13.35 (0x0D23)	Input phase loss detection level	KC100 AC driver does not detect the input voltage, for three-phase 220V、380V and 440V models, by detecting the fluctuation of the bus voltage to determine whether the input is out of phase, so the input will report out of phase fault only when adding a certain load.	10% (5 to 50%)	Changeable at any time
F13.36 (0x0D24)	Input phase loss detection time		10ms (5 to 2000ms)	Changeable at any times
F13.37 (0x0D25)	Output phase loss protection	Ones: Output phase loss protection Tens: Output phase loss protection before running 0: Disabled 1: Enabled	01 (00 to 11)	Changeable at any time
F13.40 (0x0D28)	Motor overload suppression	0: Disable 1: Enabled	1 (0 to 1)	Changeable at any time
F13.41 (0x0D29)	Motor overload protection gain	This parameter defines the motor overload protection gain	1.00 (0.20 to 10.00)	Changeable at any time
F13.42 (0x0D2A)	Motor overload pre-warning coefficient	The motor overload pre-warning coefficient is the percentage of time during which the motor runs at an overload threshold continuously without reporting an overload fault	100.0% (50.0% to 100.0%)	Changeable at any time
F13.43 (0x0D2B)	Load loss protection	When the AC driver output current is lower than F13.44(load loss detection level), and the duration is greater than F13.45 (load loss detection time), the AC driver performs load drop protection action (load drop protection action can be selected by F13.43, default free stop). During the load loss protection period, if the load recovers, the AC driver will automatically resume to operate at the set frequency. 0: Disabled 1: Enabled	0 (0 to 1)	Changeable at any time
F13.44 (0x0D2C)	Load loss detection level	This parameter defines the load loss protection trigger threshold	10.0% (0.0% to 100.0%)	Changeable at any time
F13.45 (0x0D2D)	Load loss detection time	This parameter defines the load loss protection trigger time	1.0 s (0.0s to 60.0s)	Changeable at any time

F13.48 (0x0D30)	Shutdown fault detection enable	Ones: Shutdown to ground short circuit detection enable 0: Disabled 1: Enabled Tens: Shutdown phase-to-phase short circuit detection enable 0: Disabled 1: Enabled	0x00 (0x00~0x11)	Changeable at any time
F13.49 (0x0D31)	Shutdown fault detection interval time	The fire mode function (The ones of F13.70 is not zero) has been set, and the shutdown fault detection enable has also been set. During the shutdown state, fault detection will be conducted at the specified interval. If set to 0, no detection will be performed.	0s (0s~6000s)	Changeable at any time
F13.52 (0x0D34)	Detection level of excessive speed deviation	This parameter defines the detection threshold of excessive speed deviation	20.0% (0.0% to 50.0%)	Changeable at any time
F13.53 (0x0D35)	Detection time of excessive speed deviation	This parameter defines the time length to trig excessive speed deviation detection	5.0 s (0.0s to 60.0s)	Changeable at any time
F13.60 (0x0D3C)	Auto reset attempts	This parameter defines the number of auto reset attempts	0 (0 to 20)	Changeable at any time
F13.61 (0x0D3D)	DO action during auto reset	0: Disabled 1: Enabled	0 (0 to 1)	Changeable at any time
F13.62 (0x0D3E)	Auto reset interval	This parameter defines the length of time between two consecutive failure resets	1.0 s (0.1s to 100.0s)	Changeable at any time
F13.65 (0x0D41)	Fault protection action selection 1	Ones: Input phase loss Tens: Output phase loss Hundreds : Reserved Thousands: Reserved Ten thousands: Load loss 0: Coast to stop 1: Decelerate to stop 2: Continue to run	00000 (0 to 20022)	Changeable at any time
F13.66 (0x0D42)	Fault protection action selection 2	Ones: External fault Tens: Communication exception Hundreds:EEPROM communication exception Thousands: PID feedback loss Ten thousands: reserved 0: Coast to stop 1: Decelerate to stop 2: Continue to run	00000 (0 to 02222)	Changeable at any time

F13.67 (0x0D43)	Fault protection action selection 3	Ones: Accumulative running duration reach Tens: Accumulative power-on duration reach Hundreds: User-defined fault Thousands: Reserved Tens thousands: reserved 0: Coast to stop 1: Decelerate to stop 2: Continue to run	00000 (0 to 00222)	Changeable at any time
F13.70 (0x0D46)	Fire mode function selection	Ones: 0: Fire mode invalid 1: Fire mode 1 2: Fire mode 2 3: Fire mode 3 Tens: 0:Manual reset fault 1:Automatic reset fault	10 (00~13)	Changeable only at any time
F13.71 (0x0D47)	Fire mode operate frequency	When F13.70 is not set to 0 and the fire signal is triggered , the fire mode is effective and the AC drive will operate at the frequency set by F13.71	0.00Hz (0Hz~F01.11)	Changeable at any time
F13.72 (0x0D48)	Fire mode motor operation mode	Ones: operation direction 0: Same direction 1: Opposite direction Tens: operation frequency 0: Run in the currently frequency and direction 1: Run according to the direction set for the ones units and the frequency set for F13.71 2:Run according to the current frequency direction and the frequency set for F13.71	00 (00~21)	Changeable at any time
F13.78 (0x0D4E)	Frequency selection for continued operation during faults	0: Current operate frequency 1: Set frequency 2: Upper limit frequency 3: Lower limit frequency	0 (0~3)	Changeable at any time

7.16Group F14: Communication Parameters

Parameter (address)	Name	Reference	Default (Setup range)	Adjustable properties
F14.01 (0x0E01)	MODBUS baud rate	0: 1200 BPS 1: 2400 BPS 2: 4800 BPS 3: 9600 BPS 4: 19200 BPS 5: 38400 BPS 6: 57600 BPS 7: 115200 BPS	5 (0 to 7)	Changeable at any time
F14.02 (0x0E02)	MODBUS data format	0: (N, 8,1) No check, data bit: 8, stop bit: 1 1: (E, 8,1) Even parity, data bit: 8, stop bit: 1 2: (O, 8,1) Odd parity, data bit: 8, stop bit: 1	0 (0 to 5)	Changeable at any time

		3: (N, 8,2) No check, data bit: 8, stop bit: 2 4: (E, 8,2) Even parity, data bit: 8, stop bit: 2 5: (O, 8,2) Odd parity, data bit: 8, stop bit: 2		
F14.03 (0x0E03)	Local address	This parameter defines the local communication address	1 (0 to 247)	Changeable at any time
F14.04 (0x0E04)	Response delay	Interval between the end of the AC drive receiving data and sending data to the host computer	2ms (0ms to 20ms)	Changeable at any time
F14.05 (0x0E05)	MODEBUS communication timeout	When set to 0.0s, the Modbus communication timeout is invalid. If not, it is valid. If the interval between this communication and the next communication exceeds F14.05 (MODBUS communication timeout), the system will report a communication fault	0.0 s (0.0s to 60.0s)	Changeable at any time
F14.07 (0x0E07)	Communication data transmission format	0: Standard MODBUS 1: Non-standard	0 (0 to 1)	Changeable only at stop
F14.10 (0x0E0A)	Communication master-slave control	0: Slave 1: Host	0 (0 to 1)	Changeable only at stop
F14.11 (0x0E0B)	Master-slave command linkage	0: Master-slave command linkage 1: Master-slave command is not linkage	0 (0 to 1)	Changeable only at stop
F14.12 (0x0E0C)	Select the master/slave transmission frequency instruction	0: Given frequency 1: Set frequency (target frequency) 2: Maximum frequency	0 (0 to 2)	Changeable only at stop

7.17 Group F15: Display Parameters

Parameter (address)	Name	Reference	Default (Setup range)	Adjustable properties
F15.00 (0x0F00)	M key function	0: M key disabled 1: Switchover between operating panel control and remote control (terminal I/O control or communication control) 2: Switchover between forward and reverse run 3: Forward jogging 4: Reverse jogging	0 (0 to 4)	Changeable only at stop
F15.01 (0x0F01)	STOP/RESET key function	0: The STOP/RESET key is valid only in operating panel control mode 1: The STOP/RESET key is valid in any operation mode	0 (0 to 1)	Changeable only at stop
F15.02 (0x0F02)	Load speed display coefficient	This parameter defines load speed display coefficient	1.0000 (0.0001 to 6.0000)	Changeable at any times
F15.10 (0x0F0A)	LED display 1 in running state	0: Disabled 1: Main frequency X	5 (0 to 63)	Changeable at any time

F15.11 (0x0F0B)	LED display 2 in running state	2: Auxiliary frequency Y 3: Setting frequency (after acceleration and deceleration) 4: Reference frequency (target value) 5: Running frequency 6: Output voltage 7: Output current 8: DC-Bus voltage 9: Setting torque 10: Output torque 11: Output power 12: Setting speed 13: Running speed 14: AC drive operating status 15: AC drive temperature 16: Motor temperature 17: DI state 18: DO state 19: AI voltage before correction 20: AI voltage 25: Operating panel potentiometer voltage before correction 26: Operating panel potentiometer voltage 27: AO output 29: Input PULSE frequency (0.01KHz) 30: Output PULSE frequency (0.01KHz) 31: V/f separation target voltage 32: V/f separation output voltage 33: Communication setpoint 34: PID reference 35: PID feedback 36: PID error 37: PID integral value 38: PID output 39: PLC stage 40: Count value 45: Power factor angle 46: Motor speed feedback 48: Load speed 57: Remaining running time 58: Current power-on duration 59: Current running duration 60: High-order bits of accumulative power consumption 61: Low-order bits of accumulative power consumption 62: High-order bits of current power consumption 63: Low-order bits of current power consumption	3 (0 to 63)	Changeable at any time
F15.12 (0x0F0C)	LED display 3 in running state		7 (0 to 63)	Changeable at any time
F15.13 (0x0F0D)	LED display 4 in running state		6 (0 to 63)	Changeable at any time
F15.14 (0x0F0E)	LED display 5 in running state		8 (0 to 63)	Changeable at any time
F15.15 (0x0F0F)	LED display 1 in stop state		4 (0 to 63)	Changeable at any time
F15.16 (0x0F10)	LED display 2 in stop state		8 (0 to 63)	Changeable at any time
F15.17 (0x0F11)	LED display 3 in stop state		20 (0 to 63)	Changeable at any time
F15.18 (0x0F12)	LED display 4 in stop state		26 (0 to 63)	Changeable at any time
F15.19 (0x0F13)	LED display 5 in stop state	0 (0 to 63)	Changeable at any time	

7.18 Group F16: PID Parameters

Parameter (address)	Name	Reference	Default (Setup range)	Adjustable properties
F16.00 (0x1000)	PID reference source	0: Operating panel(F16.01) 1: AI 4: Operating panel potentiometer 5: Communication 6: PULSE input (DI4)	0 (0 to 6)	Changeable at any time
F16.01 (0x1001)	Operating panel set PID reference	This parameter defines the PID reference set by operating panel	50.0% (0.0% to 100.0%)	Changeable at any time
F16.02 (0x1002)	PID reference change time	This parameter defines the time required for the PID reference to change from 0% to setting value	0.00 s (0.00s to 100.00s)	Changeable at any time
F16.03 (0x1003)	PID feedback source	0: AI 3: Operating panel potentiometer 4: Communication 5: PULSE input (DI4)	0 (0 to 5)	Changeable at any time
F16.04 (0x1004)	PID feedback filter time	This parameter defines the filtering time of PID feedback signal	0.00 s (0.00s to 60.00s)	Changeable at any time
F16.06 (0x1006)	PID initial value	This parameter defines the PID initial value	0.0% (0.0% to 100.0%)	Changeable at any time
F16.07 (0x1007)	Hold time of PID initial value	This parameter defines the hold time of PID initial value	0.00 s (0.00s to 650.00s)	Changeable at any time
F16.09 (0x1009)	Proportional gain Kp1	This parameter defines the proportional gain KP1	20.0 (0.0 to 1000.0s)	Changeable at any time
F16.10 (0x100A)	Integral time Ti1	This parameter defines the integral time Ti1	2.00 s (0.01s to 100.00s)	Changeable at any times
F16.11 (0x100B)	Derivative time Td1	This parameter defines the derivative time Td1	0.000 s (0.00s to 10.000s)	Changeable at any time
F16.12 (0x100C)	Proportional gain Kp2	This parameter defines the proportional gain KP2	20.0 (0.0 to 1000.0)	Changeable at any time
F16.13 (0x100D)	Integral time Ti2	This parameter defines the integral time Ti2	2.00 s (0.01s to 100.00s)	Changeable at any times
F16.14 (0x100E)	Derivative time Td2	This parameter defines the derivative time Td2	0.000 s (0.00s to 10.000s)	Changeable at any time
F16.15 (0x100F)	PID derivative limit	This parameter defines the PID differential limit	0.10% (0.0% to 100.0%)	Changeable at any time
F16.16 (0x1010)	PID action direction	0: Forward 1: Reverse	0 (0 to 1)	Changeable at any time
F16.17 (0x1011)	PID deviation limit	This parameter defines the PID deviation limit	0.0% (0.0% to 100.0%)	Changeable at any time
F16.20 (0x1014)	PID operation at stop	0: Disabled 1: Enabled	0 (0 to 1)	Changeable at any time
F16.22 (0x1016)	PID cut-off frequency in reverse direction	This parameter defines the PID cut-off frequency in reverse direction	1.00 Hz (0.00Hz to F01.11)	Changeable at any time

F16.23 (0x1017)	PID parameter switchover condition	0: No switchover 1: Switchover by DI 2: Automatic switchover based on deviation 3: Automatic switchover based on running frequency	0 (0 to 3)	Changeable at any time
F16.24 (0x1018)	PID parameter switchover deviation 1	This parameter defines the PID switchover deviation 1. When the PID deviation is lower than this value, use proportional gain KP1	20.0% (0.0% to F16.25)	Changeable at any time
F16.25 (0x1019)	PID parameter switchover deviation 2	This parameter defines the PID switchover deviation 2. When the PID deviation is higher than this value, use proportional gain KP2	80.0% (F16.24 to 100.0%)	Changeable at any time
F16.26 (0x101A)	PID output filter time	This parameter defines the PID output filter time	10ms (0 to 1000ms)	Changeable at any time
F16.27 (0x101B)	Upper threshold of detection on PID feedback loss	This parameter defines the upper threshold of detection on PID feedback loss	0.0% (0.0% to 100.0%)	Changeable at any time
F16.28 (0x101C)	Lower threshold of detection on PID feedback loss	This parameter defines the lower threshold of detection on PID feedback loss	0.0% (0.0% to 100.0%)	Changeable at any time
F16.30 (0x101E)	PID feedback loss detection time	This parameter defines the PID feedback loss detection time	0.0 s (0.0s to 20.0s)	Changeable at any time
F16.31 (0x101F)	PID preset frequency enable	0: No initial frequency 1: Run at the initial frequency, the initial frequency is F01.10;	0 (0 to 1)	Changeable only at stop
F16.32 (0x1020)	PID preset frequency switching voltage	Switch from preset frequency to PID setting according to AI voltage;	0.00V (-10.00 to 10.00)	Changeable at any time
F16.33 (0x1021)	PID sleep enable	0: PID sleep off 1: PID sleep enable	0 (0 to 1)	Changeable only at stop
F16.34 (0x1022)	PID sleep voltage threshold	Determine whether PID sleep according to the feedback voltage	0.00V (-10.00 to 10.00V)	Changeable at any time
F16.35 (0x1023)	PID sleep delay time	Delay sleep time after PID sleep condition is met	0.1s (0.0 to 20.0s)	Changeable at any time
F16.36 (0x1024)	PID wake up delay time	Delay wake up time after PID wake up condition is met	0.1s (0.0 to 20.0s)	Changeable at any time

7.19 Group F17: Multi-reference Parameters

Parameter (address)	Name	Reference	Default (Setup range)	Adjustable properties
F17.00 (0x1100)	Multi-reference 0 source	0: Operating panel setting frequency (F01.10) 1: AI 4: Operating panel potentiometer 5: Communication 6: Pulse-reference (DI4) 7: PID	0 (0 to 7)	Changeable at any time
F17.01 (0x1101)	Multi-reference 1	This parameter defines the multi-reference 1	5.00 Hz (0.00Hz to F01.11)	Changeable at any time
F17.02 (0x1102)	Multi-reference 2	This parameter defines the multi-reference 2	5.00 Hz (0.00Hz to F01.11)	Changeable at any time
F17.03 (0x1103)	Multi-reference 3	This parameter defines the multi-reference 3	5.00 Hz (0.00Hz to F01.11)	Changeable at any time

F17.04 (0x1104)	Multi-reference 4	This parameter defines the multi-reference 4	5.00 Hz (0.00Hz to F01.11)	Changeable at any time
F17.05 (0x1105)	Multi-reference 5	This parameter defines the multi-reference 5	5.00 Hz (0.00Hz to F01.11)	Changeable at any time
F17.06 (0x1106)	Multi-reference 6	This parameter defines the multi-reference 6	5.00 Hz (0.00Hz to F01.11)	Changeable at any time
F17.07 (0x1107)	Multi-reference 7	This parameter defines the multi-reference 7	5.00 Hz (0.00Hz to F01.11)	Changeable at any time
F17.17 (0x1111)	Simple PLC operation mode	Ones: circular mode 0: Stop after single cycle 1: Keep the final value after a single cycle 2: Continuous loop Tens : timing unit 0: seconds (s) 1: Minutes (min) 2: hours (h) Hundreds digit: power-off storage method 0: Do not store 1: Storage Thousands digit: shutdown memory mode 0: No memory when shutdown 1: Stop memory	0x0000 (0x0000 to 0x1122)	Changeable at any time
F17.19 (0x1113)	PLC segment 0 running time	Set the running time of PLC segment 0	0.0s(min/h) (0.0 to 6500.0s(min/h))	Changeable at any time
F17.20 (0x1114)	PLC phase 0 setup	Ones: running direction of this segment (also applicable to multi-speed commands) 0: Same direction 1: Reverse Tens: acceleration and deceleration time of this section 0: Acceleration and deceleration time 1 (F01.23, F01.24) 1: Acceleration and deceleration time 2 (F01.25, F01.26) 2: Acceleration and deceleration time 3 (F01.27, F01.28) 3: Acceleration and deceleration time 4 (F01.29, F01.30)	0x00 (0x00 to 0x31)	Changeable at any time
F17.21 (0x1115)	PLC first stage running time	Same as F17.19	0.0s(min/h) (0.0 to 6500.0s(min/h))	Changeable at any time
F17.22 (0x1116)	PLC phase 1 setup	Same as F17.20	0x00 (0x00 to 0x31)	Changeable at any time
F17.23 (0x1117)	PLC second stage running time	Same as F17.19	0.0s(min/h) (0.0 to 6500.0s(min/h))	Changeable at any time
F17.24 (0x1118)	PLC stage 2 setup	Same as F17.20	0x00 (0x00 to 0x31)	Changeable at any time
F17.25 (0x1119)	PLC section 3 running time	Same as F17.19	0.0s(min/h) (0.0 to 6500.0s(min/h))	Changeable at any time
F17.26 (0x111A)	PLC stage 3 setup	Same as F17.20	0x00 (0x00 to 0x31)	Changeable at any time
F17.27 (0x111B)	PLC section 4 running time	Same as F17.19	0.0s(min/h) (0.0 to 6500.0s(min/h))	Changeable at any time



F17.28 (0x111C)	PLC stage 4 setup	Same as F17.20	0x00 (0x00 to 0x31)	Changeable at any time
F17.29 (0x111D)	PLC section 5 running time	Same as F17.19	0.0s(min/h) (0.0 to 6500.0s(min/h))	Changeable at any time
F17.30 (0x111E)	PLC stage 5 setup	Same as F17.20	0x00 (0x00 to 0x31)	Changeable at any time
F17.31 (0x111F)	PLC section 6 running time	Same as F17.19	0.0s(min/h) (0.0 to 6500.0s(min/h))	Changeable at any time
F17.32 (0x1120)	PLC stage 6 setup	Same as F17.20	0x00 (0x00 to 0x31)	Changeable at any time
F17.33 (0x1121)	PLC segment 7 running time	Same as f/17.19	0.0s(min/h) (0.0 to 6500.0s(min/h))	Changeable at any time
F17.34 (0x1122)	PLC stage 7 setup	Same as F17.20	0x00 (0x00 to 0x31)	Changeable at any time
F17.51 (0x1133)	Multi-segment speed frequency 1 setting mode	0:Operating panel digital setting (F17.01) 1: AI 4: Panel potentiometer 5: Communication 6: PULSE input(DI4) 7: PID	0 (0 to 7)	Changeable at any time
F17.52 (0x1134)	Multi-segment speed frequency 1 setting mode	0:Operating panel digital setting (F17.02) 1: AI 4: Panel potentiometer 5: Communication 6: PULSE input(DI4) 7: PID	0 (0 to 7)	Changeable at any time
F17.53 (0x1135)	Multi-segment speed frequency 1 setting mode	0:Operating panel digital setting (F17.03) 1: AI 4: Panel potentiometer 5: Communication 6: PULSE input(DI4) 7: PID	0 (0 to 7)	Changeable at any time
F17.54 (0x1136)	Multi-segment speed frequency 1 setting mode	0:Operating panel digital setting (F17.04) 1: AI 4: Panel potentiometer 5: Communication 6: PULSE input(DI4) 7: PID	0 (0 to 7)	Changeable at any time
F17.55 (0x1137)	Multi-segment speed frequency 1 setting mode	0:Operating panel digital setting (F17.05) 1: AI 4: Panel potentiometer 5: Communication 6: PULSE input(DI4) 7: PID	0 (0 to 7)	Changeable at any time
F17.56 (0x1138)	Multi-segment speed frequency 1 setting mode	0:Operating panel digital setting (F17.06) 1: AI 4: Panel potentiometer 5: Communication	0 (0 to 7)	Changeable at any time

		6: PULSE input(DI4) 7: PID		
F17.57 (0x1139)	Multi-segment speed frequency 1 setting mode	0: Operating panel digital setting (F17.07) 1: AI 4: Panel potentiometer 5: Communication 6: PULSE input(DI4) 7: PID	0 (0 to 7)	Changeable at any time

7.20 Group F18: Extended terminal parameters

Parameter (address)	Name	Reference	Default (Setup range)	Adjustable properties
F18.00 (0x1200)	The function selection of AI as DI	For details, see F08.00~03 terminal function Note: When AI is more effective than 7V, it is invalid when it is less than 3V.	0 (0~51)	Changeable only at stop
F18.03 (0x1203)	The terminal characteristic of AI as DI	0: Closed effective 1: Disconnected effective	0 (0~1)	Changeable at any time

7.21 Group F19 : Communication Mapping Parameters

Parameter (address)	Name	Reference	Default (Setup range)	Adjustable properties
F19.00 (0x1300)	Communication address mapping is enabled	0: Disable 1: Enable	0 (0~1)	Changeable only at stop
F19.01 (0x1301)	Communication address mapping preimage 1	F19.01-F19.15 sets the preimage parameters of 1-15 groups communication address mapping, which correspond to F19.16-F19.30 one by one (F19.01 corresponds to F19.16). Taking the first group as an example, the user writes any address within the set range to F19.16 according to the demand, and then writes the address of the corresponding function within the KC100 inverter function code range to F19.01, user can realize the function of communicating and operating the corresponding function code of the KC100 inverter through the required specific address.	0x0000 (0x0000~0xffff)	Changeable at any time
F19.02 (0x1302)	Communication address mapping preimage 2		0x0000 (0x0000~0xffff)	Changeable at any time
F19.03 (0x1303)	Communication address mapping preimage 3		0x0000 (0x0000~0xffff)	Changeable at any time
F19.04 (0x1304)	Communication address mapping preimage 4		0x0000 (0x0000~0xffff)	Changeable at any time
F19.05 (0x1305)	Communication address mapping preimage 5		0x0000 (0x0000~0xffff)	Changeable at any time
F19.06 (0x1306)	Communication address mapping preimage 6		0x0000 (0x0000~0xffff)	Changeable at any time
F19.07 (0x1307)	Communication address mapping preimage 7		0x0000 (0x0000~0xffff)	Changeable at any time
F19.08 (0x1308)	Communication address mapping preimage 8		0x0000 (0x0000~0xffff)	Changeable at any time
F19.09 (0x1309)	Communication address mapping preimage 9		0x0000 (0x0000~0xffff)	Changeable at any time
F19.10 (0x130A)	Communication address mapping preimage 10		0x0000 (0x0000~0xffff)	Changeable at any time
F19.11 (0x130B)	Communication address mapping preimage 11		0x0000 (0x0000~0xffff)	Changeable at any time
F19.12 (0x130C)	Communication address mapping preimage 12		0x0000 (0x0000~0xffff)	Changeable at any time
F19.13 (0x130D)	Communication address mapping preimage 13		0x0000 (0x0000~0xffff)	Changeable at any time

F19.14 (0x130E)	Communication address mapping preimage 14	<p>F19.16-F19.30 sets 1-15 groups of communication address mapping parameters, which correspond to F19.01-F19.15 one by one (F19.01 corresponds to F19.16). Taking the first group as an example, the user writes any address within the set range to F19.16 according to the demand, and then writes the address of the corresponding function within the KC100 inverter function code range to F19.01, user can realize the function of communicating and operating the corresponding function code of the KC100 inverter through the required specific address.</p>	0x0000 (0x0000~0xffff)	Changeable at any time
F19.15 (0x130F)	Communication address mapping preimage 15		0x0000 (0x0000~0xffff)	Changeable at any time
F19.16 (0x1310)	Communication address mapping image 1		0x0000 (0x0000~0xffff)	Changeable at any time
F19.17 (0x1311)	Communication address mapping image 2		0x0000 (0x0000~0xffff)	Changeable at any time
F19.18 (0x1312)	Communication address mapping image 3		0x0000 (0x0000~0xffff)	Changeable at any time
F19.19 (0x1313)	Communication address mapping image 4		0x0000 (0x0000~0xffff)	Changeable at any time
F19.20 (0x1314)	Communication address mapping image 5		0x0000 (0x0000~0xffff)	Changeable at any time
F19.21 (0x1315)	Communication address mapping image 6		0x0000 (0x0000~0xffff)	Changeable at any time
F19.22 (0x1316)	Communication address mapping image 7		0x0000 (0x0000~0xffff)	Changeable at any time
F19.23 (0x1317)	Communication address mapping image 8		0x0000 (0x0000~0xffff)	Changeable at any time
F19.24 (0x1318)	Communication address mapping image 9		0x0000 (0x0000~0xffff)	Changeable at any time
F19.25 (0x1319)	Communication address mapping image 10		0x0000 (0x0000~0xffff)	Changeable at any time
F19.26 (0x131A)	Communication address mapping image 11		0x0000 (0x0000~0xffff)	Changeable at any time
F19.27 (0x131B)	Communication address mapping image 12		0x0000 (0x0000~0xffff)	Changeable at any time
F19.28 (0x131C)	Communication address mapping image 13		0x0000 (0x0000~0xffff)	Changeable at any time
F19.29 (0x131D)	Communication address mapping image 14	0x0000 (0x0000~0xffff)	Changeable at any time	
F19.30 (0x131E)	Communication address mapping image 15	0x0000 (0x0000~0xffff)	Changeable at any time	

7.22 Group D0x: Monitor Parameters

7.22.1 Group D00: Condition Monitoring Parameters

Parameter (address)	Name	Parameter (address)	Name
D00.00 (0x6000)	Main frequency reference	D00.30 (0x601E)	V/f separation target voltage
D00.01 (0x6001)	Auxiliary frequency reference	D00.31 (0x601F)	V/f separation output voltage
D00.02 (0x6002)	Frequency instruction (after acceleration and deceleration)	D00.32 (0x6020)	Communication setpoint
D00.03 (0x6003)	Frequency reference	D00.33 (0x6021)	PID reference
D00.04 (0x6004)	Running frequency	D00.34 (0x6022)	PID feedback
D00.05 (0x6005)	Output voltage	D00.35 (0x6023)	PID error
D00.06 (0x6006)	Output current	D00.36 (0x6024)	PID integral
D00.07 (0x6007)	Bus voltage	D00.37 (0x6025)	PID output

D00.08 (0x6008)	Target torque	D00.38 (0x6026)	PLC stage
D00.09 (0x6009)	Output torque	D00.39 (0x6027)	External count value
D00.10 (0x600A)	Output power	D00.44 (0x602C)	Power factor angle
D00.11 (0x600B)	Speed reference	D00.45 (0x602D)	Observed motor frequency (SVC)
D00.12 (0x600C)	Running speed	D00.47 (0x602F)	Load speed
D00.13 (0x600D)	AC drive running mode	D00.55 (0x6037)	Current fault
D00.14 (0x600E)	Inverter temperature	D00.56 (0x6038)	Remaining running duration
D00.16 (0x6010)	DI state	D00.57 (0x6039)	Accumulative power-on duration
D00.17 (0x6011)	DO state	D00.58 (0x603A)	Accumulative running duration
D00.18 (0x6012)	AI voltage (before correction)	D00.59 (0x603B)	High-order bits of accumulative
D00.19 (0x6013)	AI voltage (after correction)	D00.60 (0x603C)	Low-order bits of accumulative power consumption
D00.24 (0x6018)	Operating panel potentiometer voltage (before correction)	D00.61 (0x603D)	High-order bits of current power consumption
D00.25 (0x6019)	Operating panel potentiometer voltage (after correction)	D00.62 (0x603E)	Low-order bits of current power consumption
D00.26 (0x601A)	AO Output	D00.63 (0x603F)	Fire mode warranty mark
D00.28 (0x601C)	High-speed pulse input frequency	D00.64 (0x6040)	Stop fault detection sign
D00.29 (0x601D)	High-speed pulse output frequency		

7.22.2 Group D01: Fault Monitor Parameters

Parameter (address)	Name	Parameter (address)	Name
D01.00 (0x6100)	Last fault type	D01.36 (0x6124)	Last three fault types
D01.01 (0x6101)	Frequency reference upon the active fault	D01.37 (0x6125)	Set the frequency for the last three failures
D01.02 (0x6102)	Output frequency upon the active fault	D01.38 (0x6126)	Output frequency for the last three failures
D01.03 (0x6103)	Output voltage upon the active fault	D01.39 (0x6127)	Output voltage for the last three failures
D01.04 (0x6104)	Output current upon the active fault	D01.40 (0x6128)	Output current for the last three failures
D01.05 (0x6105)	Bus voltage upon the active fault	D01.41 (0x6129)	Bus voltage for the last three failures
D01.06 (0x6106)	Inverter temperature upon the active fault	D01.42 (0x612A)	Inverter temperature for the last three failures
D01.07 (0x6107)	Input terminal state upon the active fault	D01.43 (0x612B)	Enter the terminal status for the last three failures
D01.08 (0x6108)	Output terminal state upon the active fault	D01.44 (0x612C)	Output terminal status for the last three failures
D01.09 (0x6109)	AC driver state upon the active fault	D01.45 (0x612D)	Inverter status for the last three failures
D01.10 (0x610A)	Power-on duration upon the active fault	D01.46 (0x612E)	Power-on time for the last three failures
D01.11 (0x610B)	Running duration upon the active fault	D01.47 (0x612F)	Running time for the last three failures
D01.12 (0x610C)	Latest fault	D01.48 (0x6130)	Last four fault types
D01.13 (0x610D)	Frequency reference of the latest fault	D01.49 (0x6131)	Set the frequency for the last four failures
D01.14 (0x610E)	Output frequency of the latest fault	D01.50 (0x6132)	Output frequency for the last four failures

D01.15 (0x610F)	Output voltage of the latest fault	D01.51 (0x6133)	Output voltage for the last four failures
D01.16 (0x6110)	Output current of the latest fault	D01.52 (0x6134)	Output current for the last four failures
D01.17 (0x6111)	Bus voltage of the latest fault	D01.53 (0x6135)	Bus voltage for the last four failures
D01.18 (0x6112)	Inverter temperature of the latest fault of last failure	D01.54 (0x6136)	Inverter temperature for the last four failures
D01.19 (0x6113)	Input terminal state of the latest fault	D01.55 (0x6137)	Enter the terminal status for the last four failures
D01.20 (0x6114)	Output terminal state of the latest fault	D01.56 (0x6138)	Output terminal status for the last four failures
D01.21 (0x6115)	AC driver state of the latest fault	D01.57 (0x6139)	Inverter status for the last four failures
D01.22 (0x6116)	Power-on duration of the last fault	D01.58 (0x613A)	Power-on time for the last four failures
D01.23 (0x6117)	Running duration of the latest fault	D01.59 (0x613B)	Running time for the last four failures
D01.24 (0x6118)	Second latest fault	D01.60 (0x613C)	Last five fault types
D01.25 (0x6119)	Frequency reference of the second latest fault	D01.61 (0x613D)	Set the frequency for the last five failures
D01.26 (0x611A)	Output frequency of the second latest fault	D01.62 (0x613E)	Output frequency for the last five failures
D01.27 (0x611B)	Output voltage of the second latest fault	D01.63 (0x613F)	Output voltage for the last five failures
D01.28 (0x611C)	Output current of the second latest fault	D01.64 (0x6140)	Output current for the last five failures
D01.29 (0x611D)	Bus voltage of the second latest fault	D01.65 (0x6141)	Bus voltage for the last five failures
D01.30 (0x611E)	Inverter temperature of the second latest fault of last failure	D01.66 (0x6142)	Inverter temperature for the last five failures
D01.31 (0x611F)	Input terminal state of the second latest fault	D01.67 (0x6143)	Enter the terminal status for the last five failures
D01.32 (0x6120)	Output terminal state of the second latest fault	D01.68 (0x6144)	Output terminal status for the last five failures
D01.33 (0x6121)	AC driver state of the second latest fault	D01.69 (0x6145)	Inverter status for the last five failures
D01.34 (0x6122)	Power-on duration of the second last fault	D01.70 (0x6146)	Power-on time for the last five failures
D01.35 (0x6123)	Running duration of the second latest fault	D01.71 (0x6147)	Running time for the last five failures

7.2.2.3 Group D02: System Information

Parameter (address)	Name	Parameter (address)	Name
D02.00 (0x6200)	AC drive series	D02.06 (0x6206)	Non-stand software version of control board

D02.01 (0x6201)	Rated power of AC drive	D02.08 (0x6208)	Software version of operating panel
D02.02 (0x6202)	Rated voltage of AC drive	D02.09 (0x6209)	Customized series number
D02.03 (0x6203)	Rated current of AC drive	D02.10 (0x620A)	Internal version of control board
D02.04 (0x6204)	Software version of control board		

7.23 Fault Code Table

Operating panel display	Fault name	Operating panel display	Fault name
E0001	Acceleration overcurrent	E0015	Output phase loss
E0002	Deceleration overcurrent	E0018	Pre-charge resistor overload
E0003	Constant speed overcurrent	E0023	AC driver overload
E0004	Acceleration overvoltage	E0024	Motor overload
E0005	Deceleration overvoltage	E0025	Load loss
E0006	Constant speed overvoltage	E0026	Inverter overheat
E0007	Undervoltage at running	E0028	External failure
E0008	FO fault	E0029	Communication timeout
E0009	Output interphase short	E0030	EEPROM read/write fault
E0010	Motor short-to-ground	E0031	PID feedback loss
E0011	Current detection exception	E0032	Accumulative running duration reach
E0012	Pause-by-pulse current limit fault	E0033	Accumulative power-on duration reach
E0013	Motor auto-tuning exception	E0034	User defined fault
E0014	Input phase loss	E0041	Excessive speed deviation

8 Inspection, Maintenance and Assurance

8.1 Inspection

AC drives are composed of semiconductor devices, passive electronic devices, and moving devices, and these devices have a service life, even under normal working conditions, if the service life is exceeded, some devices may change characteristics or fail. In order to prevent this phenomenon from leading to failure, preventive inspection and maintenance such as daily inspection, regular inspection and device replacement must be carried out. It is recommended to check the machine every 3 to 4 months after installation.

Daily inspection: In order to avoid damage to the inverter and shorten the service life, please confirm the following items every day.

Table 8-1 Daily check items and countermeasures

Check Items	Check the contents	Coping strategies
Power supply	Check whether the power supply voltage meets the requirements and there is no phase power supply.	Solve according to the requirements of the nameplate.
Surroundings	Whether the installation environment meets requirements.	Identify the source and resolve it properly.
Cooling system	Inverter and motor whether there is abnormal heating and discoloration phenomenon, cooling fan working condition.	Check whether it is overloaded, tighten the screws, check whether the heat sink of the inverter is dirty, and check whether the fan is blocked.
Motors	Whether the motor has abnormal vibration and abnormal sound.	Tighten mechanical and electrical connections and lubricate mechanical
Load conditions	Whether the AC drive output current is higher than the motor or AC drive rating and has lasted for a certain time.	Confirm whether overload occurs and confirm whether the selection of inverter is correct.

Regular inspection: Under normal circumstances, it is appropriate to carry out a regular inspection every 3 months to 4 months, but in actual circumstances, please determine the actual inspection cycle according to the use of each machine and the working environment.

Table 8-2 Regular inspection items and coping strategies

Check Items	Check the contents	Coping strategies
Overall	<ul style="list-style-type: none"> Insulation resistance check; Environmental inspection. 	<ul style="list-style-type: none"> Tighten and replace defective parts; Clean and improve the operating environment.
Electrical connection	<ul style="list-style-type: none"> Wires and connecting parts are discolored, insulation is damaged, cracked, discolored and aging and other traces; Whether the connection terminal is worn, damaged, loose; Grounding check. 	<ul style="list-style-type: none"> Replace damaged wires; Tighten loose terminals and replace damaged terminals; Measure the grounding resistance and tighten the corresponding grounding terminal.
Mechanical connection	<ul style="list-style-type: none"> Whether there is abnormal vibration and sound, whether the fixing is loose. 	<ul style="list-style-type: none"> Tighten, lubricate and replace bad parts.
Semiconductor devices	<ul style="list-style-type: none"> Whether it is stained with garbage and dust; Whether there is a noticeable change in appearance. 	<ul style="list-style-type: none"> Clean operating environment; Replace damaged parts.
Electrolytic capacitance	<ul style="list-style-type: none"> Whether there is leakage, discoloration, cracking, whether the safety valve is exposed, expanded, cracked or leaking. 	<ul style="list-style-type: none"> Replace damaged parts.

Peripherals	<ul style="list-style-type: none"> Peripheral equipment appearance and insulation inspection. 	<ul style="list-style-type: none"> Clean the environment and replace damaged parts.
Printed circuit board	<ul style="list-style-type: none"> Whether there is an odor, discoloration, severe rust, and whether the connector is correct and reliable. 	<ul style="list-style-type: none"> Fastening connectors; Clean the printed circuit board; Replace the damaged printed circuit board.
Cooling system	<ul style="list-style-type: none"> Cooling fan is damaged and blocked phenomenon; Whether the heat sink is stained with garbage and dust, whether it is dirty; Whether the air intake and exhaust ports are blocked or stained with foreign bodies. 	<ul style="list-style-type: none"> Clean the operating environment; Replace damaged parts.
Keyboard	<ul style="list-style-type: none"> Keyboard is broken and display is incomplete. 	<ul style="list-style-type: none"> Replace damaged parts.
Motor	<ul style="list-style-type: none"> Whether the motor has abnormal vibration and abnormal sound. 	<ul style="list-style-type: none"> Tighten mechanical and electrical connections and lubricate motor shafts.

Note

Attention!

Do not perform related operations in the state of power on, otherwise there is a risk of electrocution and death!

When performing related operations, please cut off the power supply, and confirm that the main circuit DC voltage has dropped to a safe level, wait 5 minutes before performing related operations!

8.2 Maintenance

All the equipment and parts have a service life, the correct maintenance can extend the life, but can not solve the damage of the equipment and components, please replace the components according to the requirements.

Part	Life cycle	Part name	Life cycle	Part name	Life cycle
Fan	2 to 3 years	Electrolytic capacitor	4 to 5 years	Printed circuit board	8 to 10 years

The replacement of other components is very strict on the maintenance technology and product familiarity, and it must be strictly tested before it can be put into use after replacement, so it is not recommended that users replace other internal components by themselves. If you do need to replace, please contact the agent from which you purchased the product or the sales department of the company.

8.3 Product Warranty

1. If the product fails during the warranty period, the warranty scope is detailed in the warranty clause in the warranty card.

2. Primary fault diagnosis, in principle, is carried out by your company, but can be provided by our company or our service network for a fee according to your company's request. According to the result of negotiation with your company, if the fault is caused by our company, we will provide free service.

3. Liability exemption. The inconvenience caused to you or your customers and the damage caused to non-our products due to the failure of our products, whether within the warranty period or not, shall not fall within the scope of our company's liability.

9 Accessory Recommendation

9.1 Braking Resistors

Table 9-1 Braking resistors table

Model	Brake unit	Recommended brake resistor (braking rate ED=10%)			
		Model	Count	Size (mm*mm*mm) L* W* H	Order number
KC100-2S-0R40G/0R75L	Standard build-in	RXLG-150W-150RJ	1	170*40*20	1320300110
KC100-2S-0R75G/01R5L		RXLG-150W-150RJ	1	170*40*20	1320300110
KC100-2S-01R5G/02R2L		RXLG-150W-150RJ	1	170*40*20	1320300110
KC100-2S-02R2G/03R7L		RXLG-400W-50RJ	1	250*60*30	1320300111
KC100-4T/5T-0R75G/01R5		RXLG-300W-250RJ	1	200*60*30	1320300112
KC100-4T/5T-01R5G/02R2		RXLG-300W-250RJ	1	200*60*30	1320300112
KC100-4T/5T-02R2G/03R7		RXLG-300W-250RJ	1	200*60*30	1320300112
KC100-4T/5T-03R7G/05R5		RXLG-550W-150RJ	1	320*60*30	1320300113
KC100-4T/5T-05R5G/07R5		RXLG-800W-100RJ	1	350*60*30	1320300114

9.2 EMC Filter

In order for the KC100 series to meet the radiation and conductive emission requirements of the EN IEC 61800-3 standard, an externally adapted EMC filter is required. The EMC filter models available to customers in this series are listed below, and these filters meet the CE certification EN 61800-3 Class C2 emission requirements.

Attention!

The connection cable between the filter and the device must be as short as possible, which should be less than 30cm. The filter and the device should be connected to the unified grounding reference surface, and the grounding of the filter output terminal should be connected to the input grounding terminal of the frequency converter to ensure the reliable grounding of the filter, otherwise the filtering function of the filter cannot be played.

Note

9.2.1 External filters are available for single-phase models

Table 9-2 EMC Filter selection (single-phase 200V~240V)

Model	Power (kW)	Specification	Rated current (A)	Size(mm)	Order number
KC100-2S-0R40G/0R75L	0.4	ME440-5	5	114*57.5*46	1340300026
KC100-2S-0R75G/01R5L	0.75	ME440-10	10	114*57.5*46	1340300027
KC100-2S-01R5G/02R2L	1.5	ME440-20	20	114*57.5*46	1340300028
KC100-2S-02R2G/03R7L	2.2	ME440-20	20	114*57.5*46	1340300028

9.2.2 External filters are available for three-phase models

Table 9-3 EMC Filter selection (three-phase 38V~480V)

Model	Power (kW)	Specification	Rated current (A)	Size(mm)	Order number
KC100-4T/5T-0R75G/01R5L	0.75	ME466-5	5	120*130*50	1340300029
KC100-4T/5T-01R5G/02R2L	1.5	ME466-5	5	120*130*50	1340300029

KC100-4T/5T-02R2G/03R7L	2.2	ME466-10	10	120*130*50	1340300030
KC100-4T/5T-03R7G/05R5L	3.7	ME466-10	10	120*130*50	1340300030
KC100-4T/5T-05R5G/07R5L	5.5	ME466-20	20	120*130*50	1340300031

9.2.3 Installation requirement

- EMC filter should be installed close to the input terminal of the device, and the cable between them should be smaller than 30cm.
- Connect the ground terminal of the EMC filter to the ground terminal of the device, and ensure that the filter and device are installed on the same conductive installation plane, which is connected to the main grounding of the cabinet.
- The upper LINE end of the EMC filter should be connected to the power grid, and the LOAD end should be connected to the device.

9.3 Common EMC problems and solutions

9.3.1 Ground cables and grounding issues

Influence factor	Solution
The ground points of different devices are different	The common grounding system is used to ensure that the ground potential of all devices is the same.
If multiple devices share the same ground point, interference on one device affects other devices	Use isolation transformers to reduce the propagation of common site interference
There is unnecessary electromagnetic interference in the circuit	Use shielding technology to block external interference and reduce electromagnetic radiation and electromagnetic induction

9.3.2 ESD discharge issues

Influence factor	Solution
Moving or touching equipment when the human body is charged	Use ESD eliminators, ESD floors, and ESD shoe covers
There is a potential difference between different devices	Ensure that devices are properly grounded and that all devices are connected to the same ground point
Static electricity builds up around the device	Add an anti-static coating and clean the surface of the device regularly
The external environment is dry and the device is rubbed	Use an ESD floor and control the humidity

9.3.3 Transient interference

Influence factor	Solution
Switching operation causes sudden voltage or current change	a. Use capacitors or inductors to eliminate or attenuate b. Filter or discharge resistance is used to suppress
The device starts and stops suddenly, causing sudden changes in the power load	a. Use power filters and regulators for smooth power supply b. Soft start or soft stop technology is used to realize the smooth change of load
Lightning strikes or discharges in the atmosphere	a. Use lightning arresters, lightning protection devices and power filters b. Wrap insulation or shielding around the equipment
During signal transmission, it is subjected to transient interference from other devices or external environment	Use shielded cables or electromagnetic shielding enclosures to protect against external transient interference

9.3.4 Harness interference

Influence factor	Solution
The harness is too long or too dense	a. Shorten the length of the wire harness and minimize the cross and overlap of the wire harness b. Separate the wire harness to avoid excessive proximity between different types of wire harnesses

The device starts and stops suddenly, causing sudden changes in the power load	<ul style="list-style-type: none"> a. Make sure all wiring harnesses are properly and well grounded and connect them to the same ground point b. Select harnesses that use shielded grounding technology or electromagnetic shielding materials
Lightning strikes or discharges in the atmosphere	<ul style="list-style-type: none"> a. Use filters to reduce power supply noise and electromagnetic radiation in the harness b. Choose a harness that uses electromagnetic shielding materials
During signal transmission, it is subjected to transient interference from other devices or external environment	<ul style="list-style-type: none"> a. Select suitable wire harness materials, such as shielded wire harnesses with anti-interference characteristics or materials with low electromagnetic radiation b. Wire harness should have anti-interference design, choose the appropriate structure

9.3.5 Power supply fluctuation and inrush current

Influence factor	Solution
The device suddenly starts and stops	<ul style="list-style-type: none"> a. Use equipment such as filters, regulators or capacitors to smooth load changes b. Use soft start or soft stop technology to achieve smooth load changes
The voltage provided by the external power supply is unstable	Use a power regulator
Insufficient power supply capacity, especially when starting with high-power loads	<ul style="list-style-type: none"> a. Periodically evaluate the power capacity b. Avoid overload

9.3.6 Leakage protection circuit breaker works incorrectly

If a circuit breaker with leakage protection is used in the device, and the fault occurs, please use the following methods to solve the problem.

Leakage protector tripping phenomenon	Influence factor	Solution
The leakage protector is tripped at the moment of power-on	The anti-interference performance of leakage protection is poor	a. Use the recommended brand of leakage protection circuit breaker
	The leakage protection action current is too small	b. Replace with a leakage protection circuit breaker with a larger operating current.
	An unbalanced load is connected to the back-end	c. Transfer the unbalanced load to the front end of the leakage protection circuit breaker
	The front end of the device has a large ground capacitance	d. Try to disconnect the EMC screw or the ground end of the external EMC filter to reduce the capacitance of the input end to the ground
Leakage protector trip during operation	The anti-interference performance of leakage protection is poor	a. Use the recommended brand of leakage protection circuit breaker
	The leakage protection action current is too small	b. If it is a single inverter, ensure that the EMC screws are tightened. If multiple inverters are used, disconnect the EMC optional ground screw
	An unbalanced load is connected to the back-end	c. A simple filter is installed on the input side of the equipment, and a magnetic ring is wound around the LN and RST lines near the leakage protection points.
	The distribution capacitance of the motor cable or motor to the ground is too large	<ul style="list-style-type: none"> d. Replace with a leakage protection circuit breaker with a larger operating current e. Appropriately reduce the carrier frequency under the premise of ensuring the performance requirements f. Reduce the length of motor cables

9.3.7 Control loop interference

High-speed pulse interference: For this interference, please follow the steps below to rectify

Step	Solution
1	Use shielded twisted pair cables and ground both ends
2	Connect the motor housing to the PE end of the device

3	Connect the PE end of the device to the PE of the power grid
4	The distance between the signal line and the power line is not less than 30cm
5	The signal line increases the magnetic buckle, or the magnetic circle is 1-2 turns
6	The UVW output line of the equipment is added with a magnetic ring and wound for 2-4 turns
7	The shielded power line is adopted, and the shielding layer is well grounded

Ordinary IO signal interference: In the process of use because of wiring, grounding and other problems, there may be interference. If the device interferes with other devices, perform the following steps to rectify the fault.

Step	Solution
1	Use a shielded cable for I/O signal cables, and connect the shielded cable to the PE end
2	The motor PE is reliably connected to the PE end of the device, and the PE end of the device is connected to the grid PE
3	The UVW output line of the equipment is added with a magnetic ring and wound for 2-4 turns
4	Low speed DI with capacitive filter, recommended maximum 0.1uF
5	AI increase capacitive filtering, recommended maximum 0.22uF
6	Add a magnetic buckle or magnetic ring to the signal line and wind 1-2 turns
7	The shielded power line is adopted, and the shielding layer is well grounded

9.3.8 Communication interference

For this interference, please follow the steps below to rectify

Step	Solution
1	Add 120 matching resistors at both ends of the bus
2	Replace the multi-core shielded twisted-pair cable with a dual-terminal grounding cable
3	The distance between the communication cable and the power cable is at least 30cm
4	Add magnetic clasps on both sides of the communication cable, or surround the cable for 1-2 turns
5	The UVW output line of the equipment is added with a magnetic ring and wound for 2-4 turns
6	The shielded power line is adopted, and the shielding layer is well grounded

9.4 Other Optional Accessories

Other optional accessories are listed in the following table. See the instructions for the accessory for detailed usage. If you need the following optional parts, please specify when ordering.

Name	Specification	Function	Order number
External keyboard (without installation box)	KEY_NET (No-install box)	External keyboard operation	3030300094
External keyboard (with installation box)	KC100_NETKEY	External keyboard operation	3030300079
Keyboard installation box	Keyboard installation box	Keyboard installation accessory	3030300095
Guide rail buckle	Guide rail buckle A-20-1 (A-20-2)	For fixing guide rail	1040300030
Guide rail buckle fixing screw (The number of fixing screw used for each inverter: 3)	Iron plated nickel round head flat tail self-tapping M3.5*8PB head 6.5	For fixing guide rail buckle	1050100759
Ground lug	KC100-75MM-D001	Improved grounding effect	1720601825

10 Compliance with certification standards

10.1 CE Certification



- "CE mark" is a mark for commercial trade (production, import, sales) in the European region, indicating that the product meets the safety (LVD), electromagnetic compatibility (EMC), environmental protection (RoHS) and other directives.
- Commercial trade (production, import, sales) in the European region must have CE marking.
- This product complies with the Low Voltage Directive (LVD), Electromagnetic Compatibility (EMC) Directive and Environmental Protection (RoHS) Directive and is CE marked.
- The machinery and devices installed with this product must also meet the CE requirements for sale in Europe.
- When the CE marking is affixed to the terminal on which the product is installed, the responsibility rests with the customer who ultimately assembles the product and verifies that the machinery and devices of the final product comply with the CE certification.

10.2 Meet the requirements of the EMC directive

Note

Attention!

- This product complies with the European EMC directive 2014/30/EU and meets the requirements of standard EN IEC 61800-3, suitable for Class I and Class II environments. If used in Class I environments, this product may cause radio interference. In addition to the CE compliance requirements mentioned in this chapter, the User shall also take measures to prevent interference if necessary.
- In order to make the product comply with EMC directives and standards, it is necessary to install an EMC filter on the input side and select the recommended shielded cable on the output side, while ensuring the reliable grounding of the filter and the 360° reliable lap of the shielded layer of the output cable. The manufacturer of the system in which this product is installed is responsible for the compliance of the system with the requirements of the European EMC Directive, and according to the application environment of the system, ensure that the system meets the requirements of the standard EN IEC 61800-3.

Appendix 1: Modbus Communication Protocol

• Communication frame structure

The communication data format is as follows:

Byte composition: includes start bit, data bit, check bit, and stop bit.

Start bit	Data bits	Check bit	Stop bit
-----------	-----------	-----------	----------

A frame of information must be transmitted in a continuous stream of data. If more than 1.5 bytes of interval time is passed before the end of the entire frame transmission, the receiving device will erase the incomplete information and mistakenly assume that the next byte is the address domain part of a new frame. Similarly, if the interval between the start of a new frame and the previous frame is less than 3.5 bytes, the receiving device will consider it as a continuation of the previous frame, and the CRC check value will be incorrect due to the confusion of the frame, resulting in a communication error.

The standard structure of an RTU frame:

Frame Headers	3.5 bytes of transfer time
Slave address	Mailing address: 0 to 247 (in decimal) (0 indicates the broadcast address)
Command code	03H: Read slave parameters (read up to 12 words consecutively) 06H: Write slave parameters 10H: parameters of continuous write slave
Data area	Parameter address, number of parameters, parameter value, etc
CRC CHK low	Check value: 16-bit CRC check value
CRC CHK high	
Frame End	3.5 bytes of transfer time

• Command code and communication data description

Take reading parameter command code as an example.

For example: the slave address is 01H inverter, the memory start address is 6000H (monitoring parameter D00.00), read three consecutive words, then the structure of the frame is described as follows:

RTU host command information		RTU slave response message (normal)	
Slave address	01H	Slave address	01H
Command code	03H	Command code	03H
Starting address high	60H	number of bytes	06H
Starting address low	00H	Data address 6000H high	13H
Data count high	00H	Data address 6000H low	88H
Data number low	03H	Data Address 6001H high	00H
CRC CHK low	1BH	Data Address 6001H Low	00H
CRC CHK high	CBH	Data Address 6002H high	00H
		Data address 6002H low	00H
		CRC CHK low	C3H
		CRC CHK high	C9H

Write parameter command code consecutively as an example.

For example: the slave address is 01H AC drive, the memory start address is 9101H (multi-speed parameter F17.01, does not store EEPROM, store EEPROM address is 1101H), continuously write 3 words, then the structure of the frame is described as follows:

RTU host command information		RTU slave response information (when normal)	
Slave address	01H	Slave address	01H
Command code	10H	Command code	10H
Starting address high	91H	Starting address high	91H
Starting address low	01H	Starting address low	01H
Data count high	00H	Data count high	00H
Data number low	03H	Data number low	03H
Number of bytes	06H	CRC CHK low	FDH
First data high	00H	CRC CHK high	34H
First data low	64H		
Second data high	00H		
Second data low	C8H		
Third data high	01H		
Third data low	2CH		
CRC CHK low	BEH		
CRC CHK high	C0H		

• **Communication Control Parameter Group address description**

Function description	Address	Data Meaning statement	R/W
Communication set frequency	0x7010 (F01.04=5)	0 ~ 10000 corresponds to a maximum frequency of 0.00% ~ 100.00% (F01.11)	W
Communication set auxiliary frequency	0x7010 (F01.05=5)	0 ~ 10000 corresponds to a maximum frequency of 0.00% ~ 100.00% (F01.11)	W
Communication command Settings	0x7000	0x0000: No command 0x0001: Run forward 0x0002: Run in reverse 0x0003: Forward turn dot move 0x0004: Reverse dot move 0x0005: Slow down and stop 0x0006: Emergency stop 0x0007: Free stop 0x0008: Fault reset	W
Communication write terminal	0x70XX	The address low is: 01: Write A01 03: Write D0 04: Write pulse output	W
AC drive fault code	0x6F00	Inverter current fault code (see fault code table)	R
Communication given upper limit frequency	0x7010 (F01.12=5)	0 ~ 10000 corresponds to a maximum frequency of 0.00% ~ 100.00% (F01.11 = 5)	W
Voltage setting for VF separation	0x7010 (F05.20=5)	0 ~ 10000 corresponds to 0.00% ~ 100.00% of the rated voltage value	W
Maximum torque source under speed control (electric)	0x7010 (F06.11=5)	0 ~ 10000 corresponds to 0.00% ~ 100.00% upper set value (F06.12)	W

Maximum torque source under speed control (power generation)	0x7010 (F06.13=5)	0 ~ 10000 corresponds to 0.00% ~ 100.00% upper set value (F06.14)	W
Communicate the given PID setpoint	0x7010 (F16.00=5)	0 to 10000 corresponds to 0.00% to 100.00%	W
Communicate the given PID feedback value	0x7010 (F16.03=4)	0 to 10000 corresponds to 0.00% to 100.00%	W
Multi-speed reference 0 frequency setting	0x7010 (F17.00=5)	0 ~ 10000 corresponds to a maximum frequency of 0.00% ~ 100.00% (F01.11)	W
Failure status reading	0x61XX	Inverter fault status (save up to two faults) (see fault code table)	R
Digital input terminal status	0x6010	0x6010: DI terminal input status	R
Digital output terminal status	0x6011	0x6011: DO terminal output status	R
Analog input terminal	0x6013/0x6019	0x6013: AI terminal input voltage/current 0x6019: Keyboard Potentiometer input voltage	R
Analog output terminal	0x601A	0x601A: AO terminal output voltage/current (0-1000 corresponds to output 0V ~ 10V, 0mA ~ 20mA)	R

Note: For other function code addresses see the "Address" column in the function code brief table.

When using the write command (06H or 10H) to write F00 ~ F15 parameter group parameters, if the function code parameter address field height of half a byte is 8, only write to the inverter RAM, power off is not stored; If the function code parameter address field height half byte is 0, write to EEPROM, that is, power failure storage.

For example, parameters F00.xx: 0x80xx (write RAM), 0x00xx (save to EEPROM); Parameter F01.xx: 0x81xx (write RAM) 0x01xx (store in EEPROM), and so on for other parameter group parameters. When the F00 to F15 parameter group parameters are read, the address height is 0, for example, F03.xx: 0x03xx.

When using the write command (06H or 10H) to write F16 ~ F17 parameter group parameters, if the function code parameter address field height is 9, only write to the AC drive RAM, power off is not stored; If the function code parameter address field height half byte is 1, write to EEPROM, that is, power failure storage.

For example, parameter F16.xx: 0x90xx (write RAM) 0x10xx (save to EEPROM); Parameter F17.xx: 0x91xx (write RAM) 0x11xx (store in EEPROM), and so on for other parameter group parameters. When reading F16 to F17 parameter group parameters, the address height is 1, such as reading F17.xx: 0x11xx.

When the communication is abnormal, the slave response message will appear such as the following: (For the specific error code, see the meaning of the error code)

RTU Slave response message (when reading exception)	
Slave address	01H
Error flag	83H
Error Code	04H
CRC CHK low	40H
CRC CHK high	F3H
RTU slave response message (when write exception)	
Slave address	01H
Error flag	86H
Error Code	03H
CRC CHK low	02H
CRC CHK high	61H
RTU slave response message (when continuous write exception)	
Slave address	01H
Error flag	90H
Error Code	03H

CRC CHK low	0CH
CRC CHK high	01H

• **Error code meaning for a slave to respond to an abnormal message**

Error code	Meaning	Instructions
03	Wrong password	The user password written is different from the password set by the user
01	Read/write command error	Error in read/write command code
04	CRC check error	The CRC verification code is incorrect. Procedure
02	Function code invalid address	The read/write address does not belong to the scope of the read/write function code
03	Function code invalid parameter	The read and write parameters do not belong to the scope of function code parameters
04	Parameter change invalid	Running Status No Some parameters cannot be changed

Importa y distribuye en Argentina:

ECFA

ECFA S.R.L.

 Av. San Juan 4063 (C1233ABK) - Buenos Aires - Argentina

 +54 11 4923-6566

 ventas@ecfa.com.ar

 <https://www.ecfa.com.ar>